



#PLANLICHTPROMISE

KATALOG 2024 | 2025

#PLANLICHTPROMISE

Unser Versprechen an Sie

Katalog 2024 | 2025

1	Produktüberblick <i>Product overview Aperçu des produits</i>	3
2	Vorwort der Geschäftsführung <i>Foreword by the management Préface de la direction</i>	9
3	Die Welt von PLANLICHT <i>The world of PLANLICHT Le monde de PLANLICHT</i>	13
4	Produktneuigkeiten <i>Product news Nouveautés produits</i>	33
5	Produktfamilien & Projektinspirationen <i>Product families & project inspirations Familles de produits & inspirations de projets</i>	47
6	Produktdetails <i>Product details Détails du produit</i>	161
7	Nützliche Informationen <i>Helpful information Informations pratiques</i>	457

Überblick nach Montagearten

Overview: Mounting types | Aperçu: Types de montage

4

Überblick nach Produktfamilien

Overview: Product families | Aperçu: Familles de produits

6

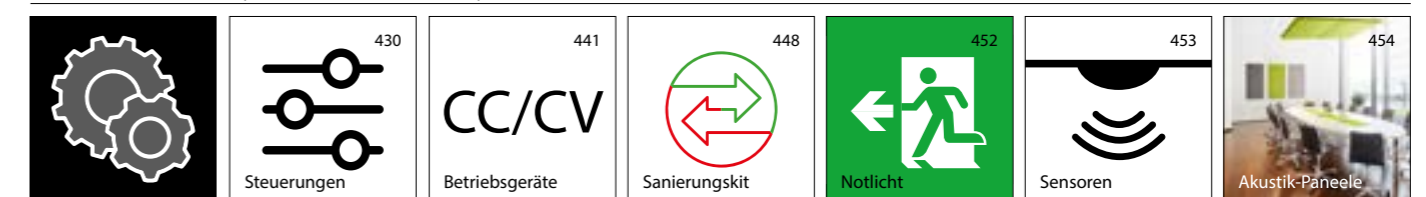
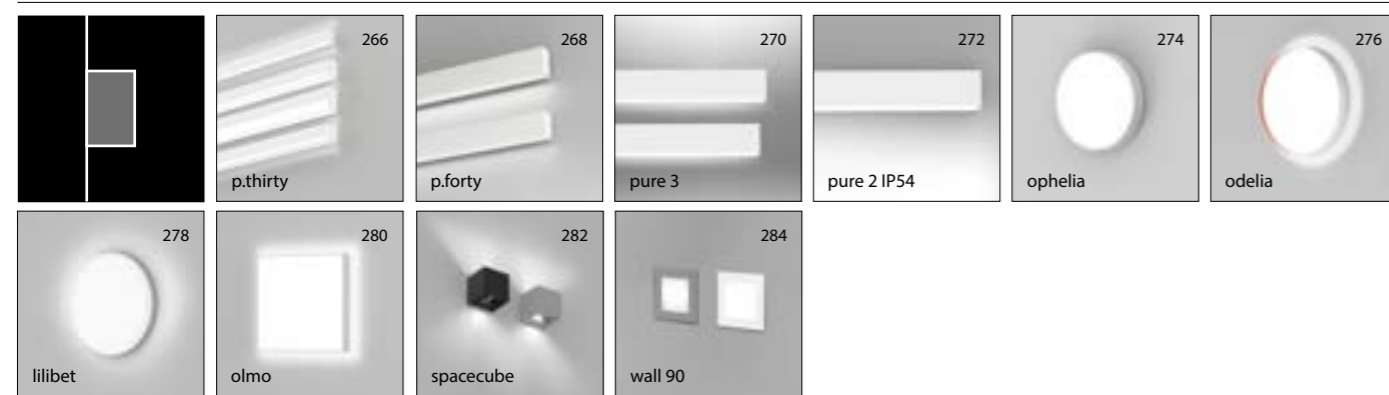
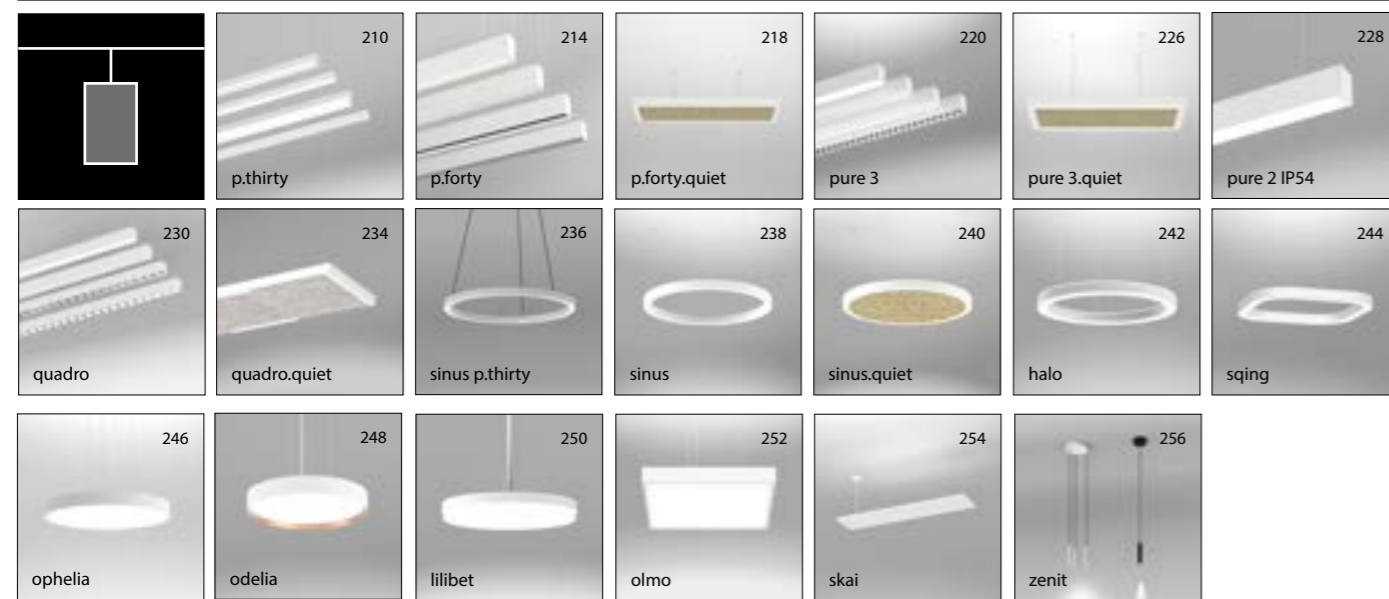
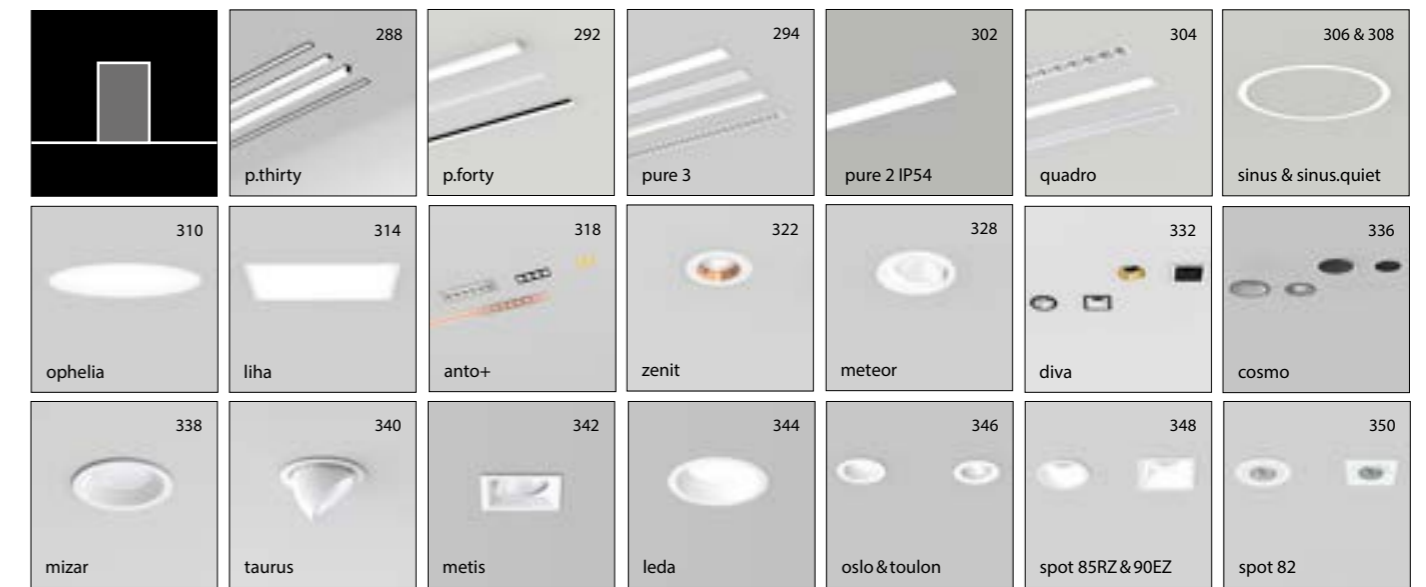
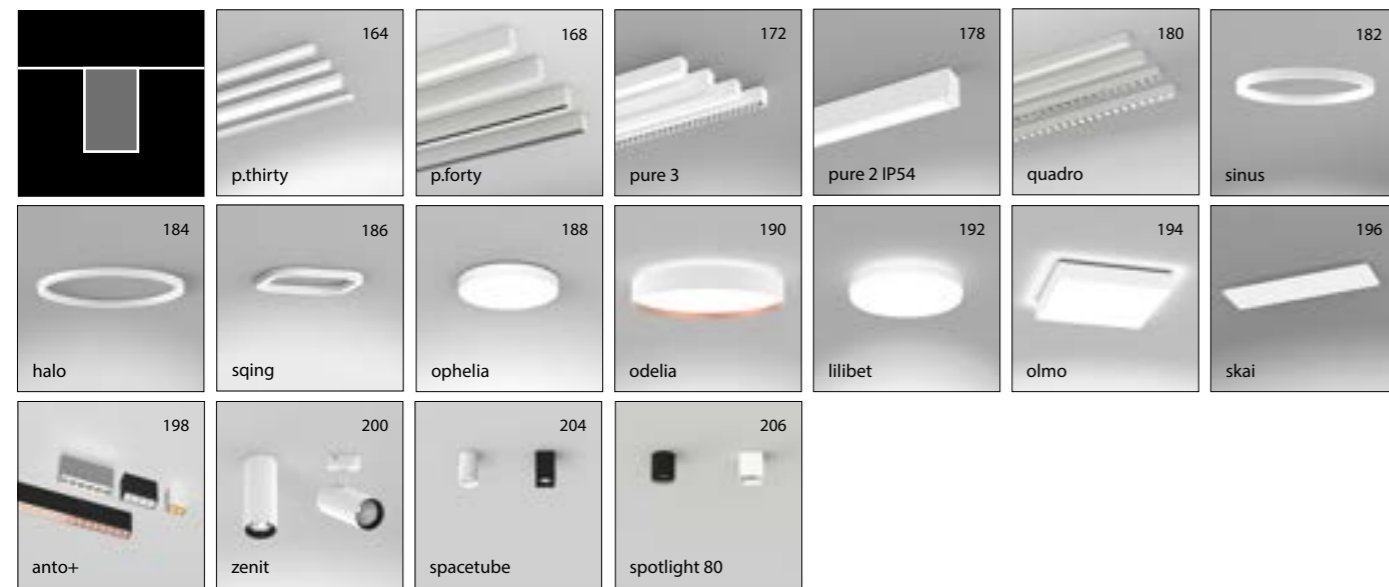

NEW Produktneuigkeiten | Überblick
 Product News | Overview
 Nouveautés produit | Aperçu

33

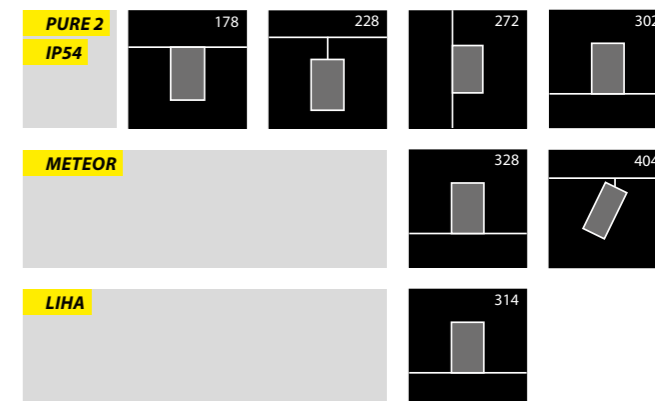
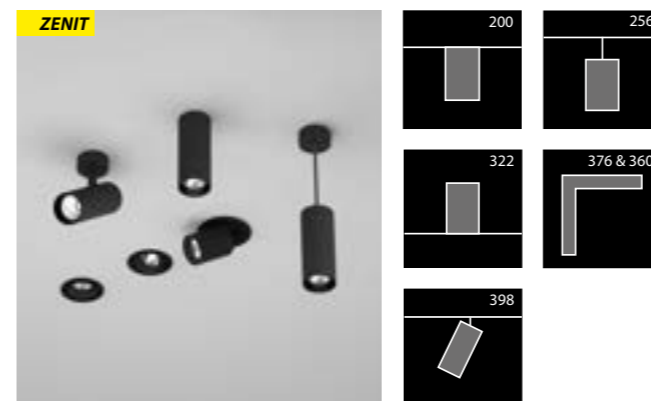
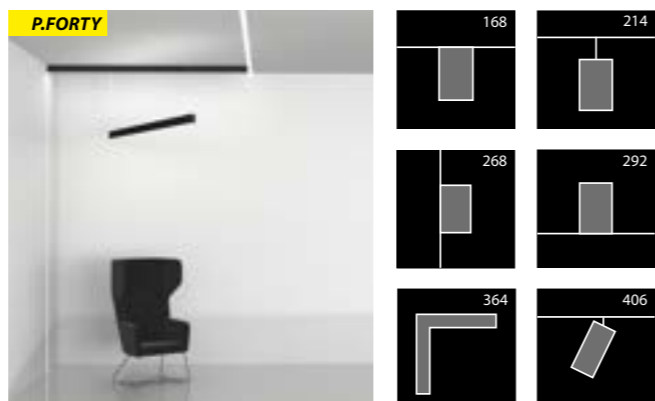
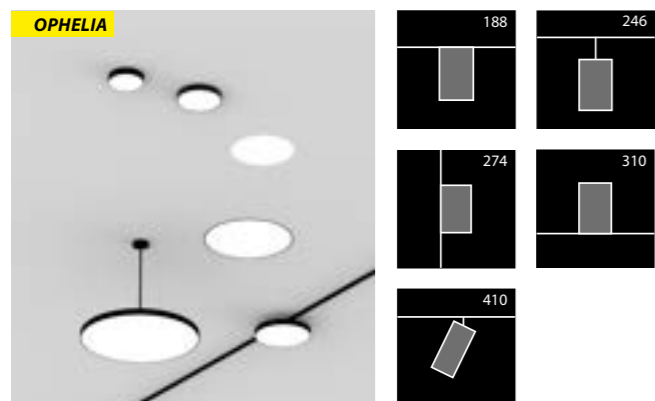
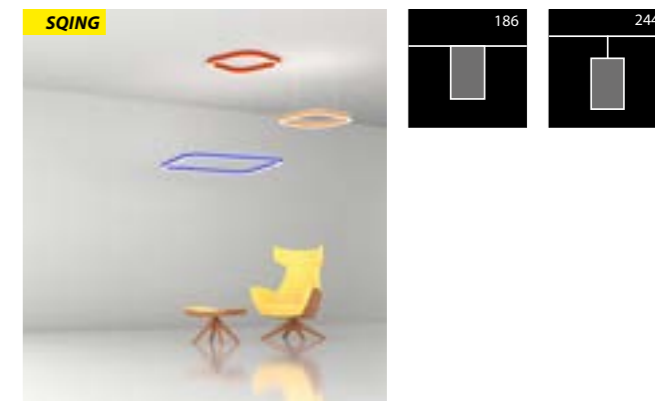
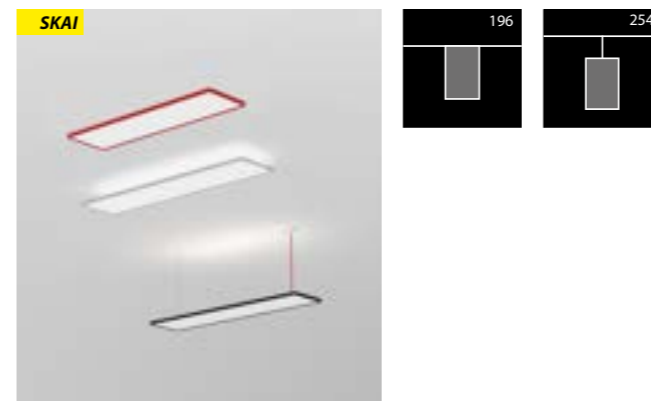
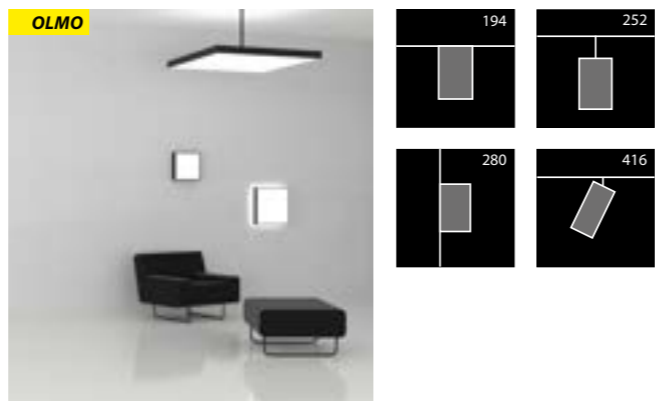
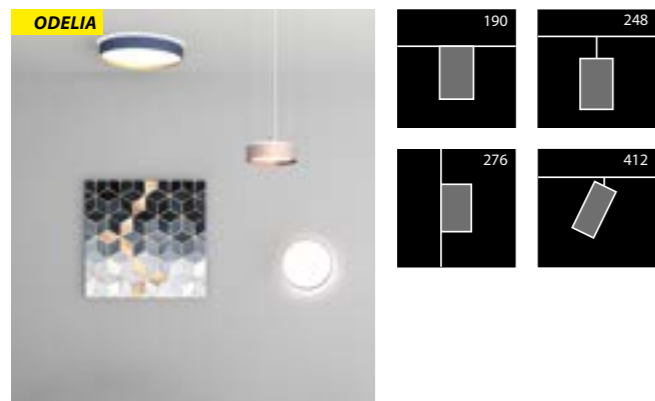
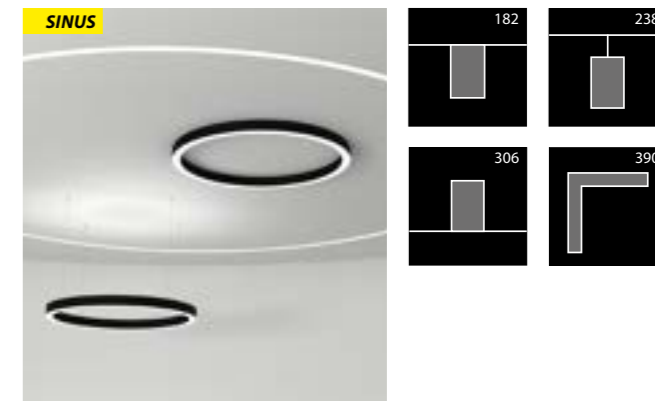
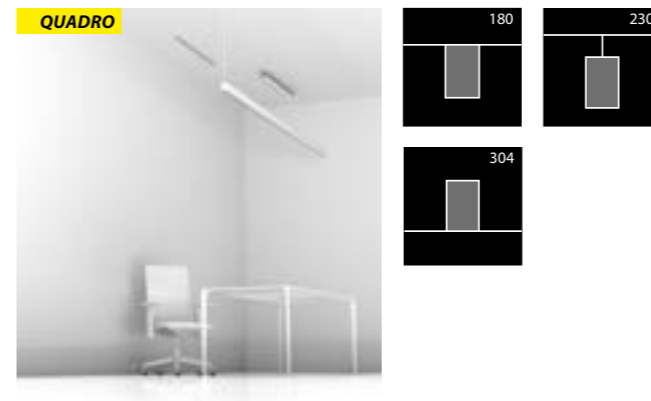
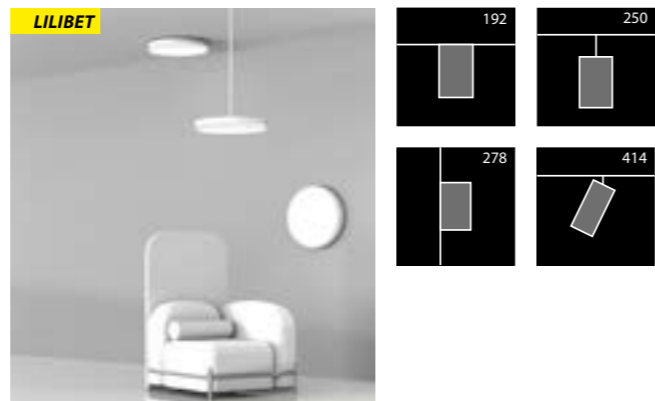
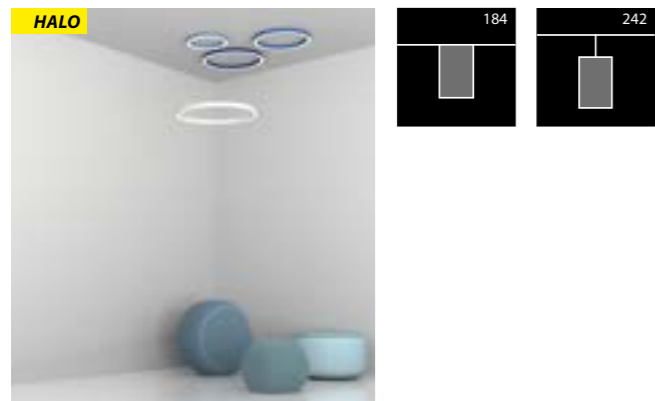
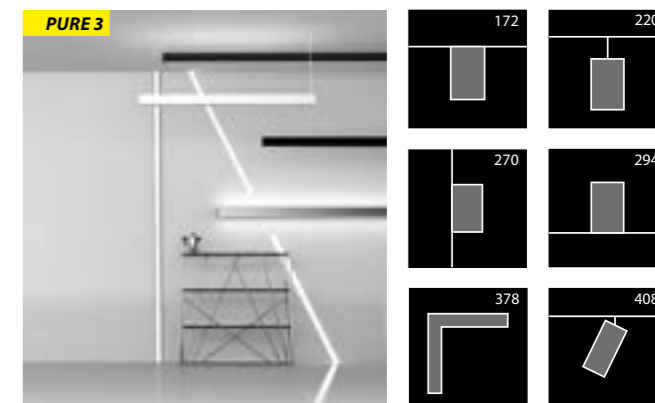
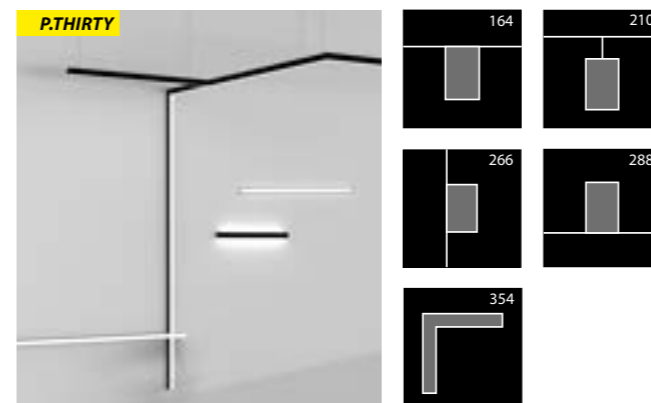
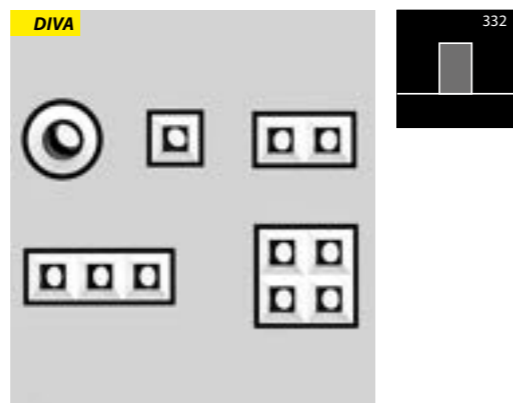
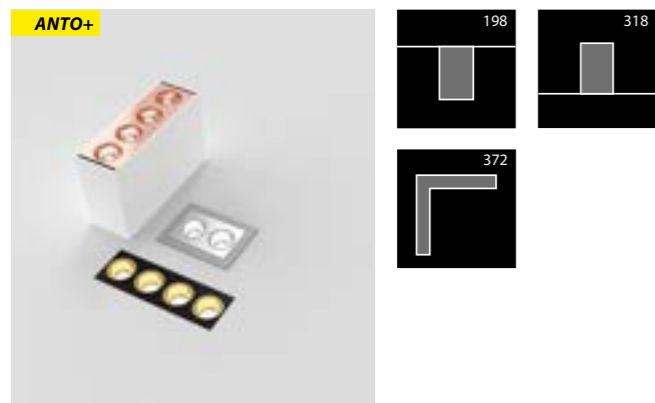

VORWORT DER GESCHÄFTSFÜHRUNG

Foreword by the management | Préface de la direction



**Liebe Freunde von PLANLICHT,
liebe Lichtbegeisterte,**

voller Freude dürfen wir Ihnen unseren neuen Katalog 2024 | 2025 „#planlichtpromise“ präsentieren: eine strahlende Schatztruhe voller Inspirationen für „leuchtende“ Projekte, einem Einblick in unsere neuesten Produktinnovationen und natürlich mit allen Details rund um das vielfältige Produktsortiment von PLANLICHT.

Was hat es mit dem Katalog-Titel „#planlichtpromise“ auf sich?

PLANLICHT bietet Ihnen ein durchdachtes Gesamtpaket: Exzellente Produktqualität, höchste Effizienz und ein äußerst ansprechendes Preis-Leistungs-Verhältnis.

Wir versprechen Ihnen ein erstklassiges Lichterlebnis, das durch unsere energieeffizienten LED-Leuchten und individuell gestalteten Lichtlösungen ermöglicht wird – alles in nachhaltiger Produktion in Österreich gefertigt und in perfekter Balance zwischen Leistungsumfang und Ihrem Budget.

Unsere vier Jahrzehnte an Erfahrung stehen für ausgezeichnete Beratung und Planung, herausragenden Kundenservice sowie hochwertige und langlebige Produkte auf dem neuesten Stand der Technik. Als preisgekröntes Familienunternehmen und zertifizierter Lehrbetrieb setzen wir auf Innovation, Nachhaltigkeit und Zusammenarbeit.

Tauchen Sie ein in unsere Produktwelt, die maßgeschneiderte Lösungen für unterschiedlichste Bedürfnisse bereithält. Wir möchten nicht nur optimales Licht schaffen, sondern Ihnen auch ein individuelles und angenehmes Erlebnis ermöglichen.

Begleiten Sie uns auf dem Weg in eine leuchtendere Welt!

#planlichtpromise

Strahlende Grüße,

Felicitas Kohler

Ihre Felicitas Kohler,
CEO PLANLICHT & PLANLICHT GROUP

Gerald Kohler

Ihr Gerald Kohler,
COO PLANLICHT & PLANLICHT GROUP



FOREWORD

Dear PLANLICHT's friends,
dear lighting enthusiasts,

we are delighted to present our new 2024 | 2025 catalogue „#planlichtpromise“: a radiant treasure chest full of inspiration for „luminous“ projects, an insight into our latest product innovations and, of course, all the details about PLAN-LICHT's diverse product range.

What is the catalogue title „planlichtpromise“ all about?

PLANLICHT offers you a well-thought-out overall package: excellent product quality, maximum efficiency, and an extremely attractive price-performance ratio.

We promise you a first-class lighting experience made possible by our energy-efficient LED luminaires and customised lighting solutions - all manufactured in sustainable production in Austria and in perfect balance between the scope of work and your budget.

Our four decades of experience stand for excellent advice and planning, outstanding customer service and high-quality, durable, state-of-the-art products. As an award-winning family business and certified company for apprenticeships, we focus on innovation, sustainability and collaboration.

Immerse yourself in our world of products, which offers customised solutions for a wide range of needs. We not only want to create optimal light, but also provide you with a personalised and pleasant experience.

Join us on our journey to a brighter world!

#planlichtpromise

Radiant regards,



Your/ Votre Felicitas Kohler,
CEO PLANLICHT & PLANLICHT GROUP

PRÉFACE

Chers amis de PLANLICHT,
chers passionnés de lumière,

c'est avec plaisir que nous vous présentons notre nouveau catalogue 2024 | 2025 « #planlichtpromise » : un coffre au trésor rayonnant, plein d'inspiration pour des projets « lumineux », un aperçu de nos nouvelles innovations de produits et, bien sûr, tous les détails sur la gamme variée de produits de PLANLICHT.

Qu'est-ce que signifie le titre du catalogue «planlichtpromise»?

PLANLICHT vous offre un paquet global bien pensé : une excellente qualité de produit, une efficacité maximale et un rapport qualité-prix extrêmement attractif.

Nous vous promettons une expérience d'éclairage de première classe, réalisée par nos luminaires à LED efficaces en énergie et nos solutions d'éclairage personnalisées – le tout fabriqué en Autriche dans le cadre d'une production durable et en parfait équilibre entre l'étendue des prestations et votre budget.

Nos quatre décennies d'expérience sont synonymes d'excellence en matière de conseil et de planification, de service clientèle et de produits de qualité durables et à la pointe de la technologie. En tant qu'entreprise familiale primée et entreprise d'apprentissage certifiée, nous misons sur l'innovation, la durabilité et la collaboration.

Plongez dans notre univers de produits qui propose des solutions sur mesure pour les besoins les plus divers. Notre but, ce n'est pas seulement de créer une lumière optimale, mais aussi de vous permettre de vivre une expérience individuelle et agréable.

Rejoignez-nous sur la voie d'un monde plus lumineux !

#planlichtpromise

Des salutations lumineuses,



Your/ Votre Gerald Kohler,
COO PLANLICHT & PLANLICHT GROUP

PLANLICHT | DIE LEIDENSCHAFT FÜR LICHT



Leuphana Universität Lüneburg | Foto: MarThem Fotografie

Als Tiroler Familienunternehmen steht **PLANLICHT** seit mehr als 35 Jahren international für hochqualitative architektonische LED-Lichtlösungen und erstklassige Servicestandards.

Mit eigener Fertigung in der Zentrale im Tiroler Vomp und dem zweiten Produktionsstandort (PLANFACTORY) im steirischen Murau bieten wir das optimale Licht für unterschiedlichste Anwendungen - von Wohnen und Gastronomie über Shops und Ausstellungsräume bis hin zu Büros, Schulen und Kindergärten.

Wir stellen die Bedürfnisse unserer Kund:innen in den Vordergrund und bieten ihnen ständig das, was sie verdienen – das Beste!

PLANLICHT | PASSION FOR LIGHT

*As a Tyrolean family business, **PLANLICHT** has stood for over 35 years as an international provider of high-quality architectural LED lighting solutions and first-class service standards.*

With our own manufacturing facility at our headquarters in Vomp, Tyrol, and a second production site (PLANFACTORY) in Murau, Styria, we offer optimal lighting for various applications - from residential and gastronomy settings to shops and exhibition spaces, as well as offices, schools, and kindergartens.

We prioritize the needs of our customers and continuously offer them what they deserve - the best!

PLANLICHT | LA PASSION POUR LA LUMIÈRE

*En tant qu'entreprise familiale tyrolienne, **PLANLICHT** est depuis plus de 35 ans un fournisseur international de solutions d'éclairage LED architecturales de haute qualité et de normes de service de premier plan.*

Avec notre propre site de fabrication à notre siège social à Vomp, Tyrol, et un deuxième site de production (PLANFACTORY) à Murau, Styrie, nous proposons un éclairage optimal pour diverses applications - des environnements résidentiels et gastronomiques aux boutiques et espaces d'exposition, ainsi que pour les bureaux, écoles et jardins d'enfants.

Nous plaçons les besoins de nos clients au premier plan et leur offrons en permanence ce qu'ils méritent - le meilleur !

Bei **PLANLICHT** versprechen wir Ihnen maßgeschneiderte, hocheffiziente architektonische LED-Lichtlösungen mit dem Qualitätssiegel „made in Austria“!

*At **PLANLICHT** we make a promise to produce lighting solutions with the lowest power consumption exclusively in Austria!*

*Chez **PLANLICHT**, nous nous engageons à produire des solutions d'éclairage à la consommation d'énergie la plus basse exclusivement en Autriche !*



UNSERE MEILENSTEINE | ÜBER 35 JAHRE ERFAHRUNG



1986

FIRMENGRÜNDUNG

Die Firma PLANLICHT wird von Johann Findl gegründet.

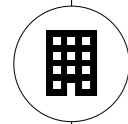

1989

BAU FIRMENGEBÄUDE

Das PLANLICHT-Firmengebäude wird in Vomp bei Schwaz gebaut.

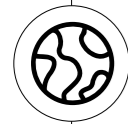

2003

WELTWEIT VERTRETEN

Der erfolgreiche Einstieg in die technisch-architektonische Beleuchtung gelingt.

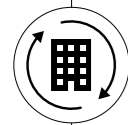

2011

UM-/NEUBAU

Die Modernisierung des Gebäudes ermöglicht schnellere und effektivere Arbeitsabläufe.



2013

ÜBERGABE GESCHÄFTSFÜHRUNG

Felicitas Kohler – Tochter des Firmengründers – übernimmt mit ihrem Ehemann Gerald Kohler die Firma PLANLICHT.

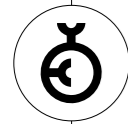

2015

GERMAN DESIGN AWARD WINNER

Die ikonische Ringleuchte halo (Design: Nina Mair) erhält den German Design Award - nur eine von zahlreichen Auszeichnungen.



2016

UNTERNEHMERIN DES JAHRES

Felicitas Kohler wird als Unternehmerin des Jahres 2016 im Bereich Export ausgezeichnet.



2021

PLANLICHT GROUP

Gründung der PLANLICHT GROUP, die heute die Unternehmen PLANLICHT, CARE BY LIGHT, ALMUT von Wildheim und PLANFACTORY umfasst.

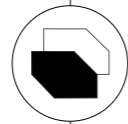

2022

PLANFACTORY

Inbetriebnahme der 2. Produktionsstätte im steirischen Murau.



2023

AUSZEICHNUNGEN

PLANLICHT wird zum „Besten Familienunternehmen 2023 | Tirol“ gekürt und Felicitas Kohler darf sich über die Auszeichnung zur „Steirischen Unternehmerin des Jahres 2023 | Kategorie Beste Nachhaltige“ und den „Unternehmerinnen Award 2023“ in der Kategorie Gründung & Start-up (jeweils für die PLANFACTORY) freuen.



GREEN-LINIE

Die neue, nachhaltige green-Produktlinie wird vorgestellt (pure 3.green).

MILESTONES | OVER 35 YEARS OF EXPERIENCE

1986: FOUNDING | PLANLICHT is founded by Johann Findl.

1989: CONSTRUCTION OF THE COMPANY BUILDING | The PLANLICHT company building is constructed in Vomp near Schwaz.

2003: GLOBAL PRESENCE | Successful entry into the technical-architectural lighting market.

2011: RENOVATION/NEW CONSTRUCTION | Modernization of the building enables faster and more effective workflows.

2013: MANAGEMENT HANDOVER | Felicitas Kohler - daughter of the company founder - and her husband Gerald Kohler take over PLANLICHT.

2015: GERMAN DESIGN AWARD WINNER | The iconic halo ring luminaire (Design by Nina Mair) receives the German Design Award - just one among numerous accolades.

2016: BUSINESSWOMAN OF THE YEAR | Felicitas Kohler is awarded Businesswoman of the Year 2016 in the Export category.

2021: PLANLICHT GROUP | Establishment of the PLANLICHT GROUP, comprising today the companies PLANLICHT, CARE BY LIGHT, ALMUT von Wildheim, and PLANFACTORY.

2022: PLANFACTORY | Opening of the second production facility in Murau, Styria.

2023: AWARDS | PLANLICHT is honoured as the „Best Family Business 2023 | Tyrol“, and Felicitas Kohler receives awards for „Styrian Businesswoman of the Year 2023 | Best Sustainable Category“ and the „Entrepreneurial Award 2023“ in the category of Establishment & Start-up (both for PLANFACTORY).

2023: GREEN-LINE | Introduction of the new sustainable green product line (pure 3.green).

PLANLICHT | LA PASSION POUR LA LUMIÈRE

1986: FONDATION | PLANLICHT est fondée par Johann Findl.

1989: CONSTRUCTION DU BÂTIMENT DE L'ENTREPRISE | Le bâtiment de l'entreprise PLANLICHT est construit à Vomp, près de Schwaz.

2003: PRÉSENCE MONDIALE | Entrée réussie sur le marché de l'éclairage technique et architectural.

2011: RÉNOVATION/NOUVELLE CONSTRUCTION | La modernisation du bâtiment permet des flux de travail plus rapides et plus efficaces.

2013: PASSATION DE POUVOIR | Felicitas Kohler – fille du fondateur de l'entreprise – et son mari Gerald Kohler reprennent PLANLICHT.

2015: LAURÉAT DU PRIX DESIGN ALLEMAND | L'emblématique luminaire annulaire Halo (Design de Nina Mair) reçoit le German Design Award - l'une des nombreuses récompenses.

2016: FEMME D'AFFAIRES DE L'ANNÉE | Felicitas Kohler est désignée Femme d'Affaires de l'Année 2016 dans la catégorie Exportation.

2021: GROUPE PLANLICHT | Création du Groupe PLANLICHT, comprenant aujourd'hui les entreprises PLANLICHT, CARE BY LIGHT, ALMUT von Wildheim et PLANFACTORY.

2022: PLANFACTORY | Ouverture du deuxième site de production à Murau, en Styrie.

2023: RÉCOMPENSES | PLANLICHT est honoré en tant que „Meilleure Entreprise Familiale 2023 | Tyrol“, et Felicitas Kohler reçoit des récompenses pour „Femme d'Affaires de l'Année 2023 en Styrie | Meilleure Catégorie Durable“ et le „Prix de l'Entrepreneuriat 2023“ dans la catégorie Création & Démarrage (tous deux pour PLANFACTORY).

2023: GREEN-LINE | Introduction de la nouvelle ligne de produits verts durables (pure 3.green).

© Tom Lamm



PLANLICHT-Firmengründer Johann Findl mit Gattin Ruth sowie Felicitas und Gerald Kohler, bei der feierlichen Eröffnung der PLANFACTORY im Juni 2023. | PLANLICHT company founder Johann Findl with his wife Ruth and Felicitas and Gerald Kohler at the grand opening of the PLANFACTORY in June 2023. | Le fondateur de PLANLICHT, Johann Findl, son épouse Ruth ainsi que Felicitas et Gerald Kohler, lors de l'inauguration solennelle de PLANFACTORY en juin 2023.

UNSER VERSPRECHEN AN SIE | IHRE VORTEILE BEI PLANLICHT



LIGHT MEETS QUALITY

Vertrauen Sie auf Qualität von PLANLICHT

Wir liefern montagefreundliche Produkte – nachhaltig produziert in Österreich – mit 100%iger Qualitätssicherung. Das Einhalten der vereinbarten Liefertermine versteht sich bei uns von selbst.

Trust in quality

We provide easy-to-install products - sustainably manufactured in Austria - with 100% quality assurance. Meeting agreed delivery schedules is a given for us.

Faites confiance à la qualité de PLANLICHT

Nous fournissons des produits faciles à installer - fabriqués de manière durable en Autriche - avec une assurance qualité à 100%. Le respect des délais de livraison convenus est une évidence pour nous.



Die Vorteile, PLANLICHT als den kompetenten Lichtexperten für Ihre Projekte zu wählen, liegen auf der Hand.

Sie erhalten bei PLANLICHT eine **partnerschaftliche Zusammenarbeit** und können sich auf **Stabilität im Service** und **ökologisch nachhaltige Produkte** verlassen.

Ihre Vorteile sind neben einem **sorgenfreien Projektablauf** auch **einzigartige LED-Lichtlösungen** und Sie profitieren jederzeit vom Wissen, dass PLANLICHT-Produkte eine **nachhaltige Qualitätssicherheit durch die österreichische Fabrikation** gewährleisten.

Unsere Empfehlungen an Sie geben Ihnen gleichzeitig **grenzenlosen Freiraum für Ihre persönliche Gedankenfreiheit**. Sie haben die Sicherheit, dass die gemeinsam definierte **Produktauswahl genau auf Ihr Projekt abgestimmt** ist, um dadurch individuelle Stimmungen und Emotionen in Ihren Räumen zu erzeugen.

OUR PROMISE TO YOU | YOUR ADVANTAGES WITH PLANLICHT

The advantages of choosing PLANLICHT as the proficient lighting expert for your projects are evident.

At PLANLICHT, you will experience a **collaborative partnership** and can rely on **stability in service** and **ecologically sustainable products**.

Your benefits include not only a **worry-free project execution** but also **unique LED lighting solutions**. You will continuously benefit from the assurance that PLANLICHT products ensure **sustainable quality through Austrian manufacturing**.

Our recommendations simultaneously provide you with **limitless freedom for your personal thoughts**. You can be assured that the jointly defined **product selection is precisely tailored to your project**, thus generating individual moods and emotions in your spaces.

NOTRE ENGAGEMENT ENVERS VOUS | VOS AVANTAGES AVEC PLANLICHT

Les avantages de choisir PLANLICHT en tant qu'expert compétent en éclairage pour vos projets sont évidents.

Chez PLANLICHT, vous bénéficiez d'une **collaboration partenariale** et pouvez compter sur la **stabilité du service** ainsi que sur des **produits écologiquement durables**.

Oltre une **exécution de projet sans souci**, vos avantages comprennent des **solutions d'éclairage LED uniques**. Vous bénéficiez en permanence de l'assurance que les produits PLANLICHT garantissent **une qualité durable grâce à leur fabrication autrichienne**.

Nos recommandations vous offrent simultanément une **liberté totale pour exprimer vos idées personnelles**. Vous pouvez avoir l'assurance que la sélection de **produits définie ensemble est spécifiquement adaptée à votre projet**, afin de créer des ambiances et des émotions uniques dans vos espaces.



LIGHT MEETS COLLABORATION

Tauschen Sie sich mit uns aus

Sie erreichen unser Kundenservicecenter Montag - Donnerstag von 7:30 - 17:00 Uhr und Freitag von 7:30 - 12:00 Uhr. Wir bearbeiten Ihre Anfragen garantiert innerhalb eines Arbeitstages.

Unsere erfahrenen Expert:innen erledigen Ihren individuellen Planungsauftrag innerhalb von vier Arbeitstagen und stellen alle benötigten Informationen digital zur Verfügung.

Engage in dialogue

You can reach our customer service centre Monday through Thursday from 7:30 am to 5:00 pm and Friday from 7:30 am to 12:00 pm. We guarantee to address your inquiries within one business day.

Our experienced experts will complete your individual planning request within four business days and provide all required information digitally.

Échangez avec nous

Vous pouvez contacter notre centre de service client du lundi au jeudi de 7h30 à 17h00 et le vendredi de 7h30 à 12h00. Nous nous engageons à traiter vos demandes dans un délai d'une journée ouvrable.

Nos experts expérimentés traitent votre demande de planification personnalisée dans un délai de quatre jours ouvrables et fournissent toutes les informations nécessaires de manière numérique.





SIZE MEETS SHAPES

Gut in Form: Das Leuchtensortiment bei PLANLICHT könnte nicht vielseitiger sein! Vom minimalistischen Downlight über verschiedenste Flächenleuchten bis hin zum multifunktionalen Profilsystem bieten wir unseren Kunden maximale Freiheit bei der Gestaltung. Und sollten Sie dennoch nicht die richtige Form und Größe für Ihr Projekt finden, dann sprechen Sie uns an!

PLANLICHT versteht sich als Lösungsanbieter. Und als solcher gehen wir auch die Extra-Meile.

In good shape: the range of luminaires at PLANLICHT couldn't be more versatile! From minimalist downlights to a wide variety of surface luminaires and multifunctional profile systems, we offer our customers maximum freedom in design. And if you still can't find the right shape and size for your project, just talk to us! PLANLICHT sees itself as a solution provider. And, as such, we also go the extra mile.

Bien en forme : l'assortiment de luminaires de PLANLICHT ne pourrait être plus varié ! Du downlight minimaliste au système de profilé multifonctionnel en passant par des luminaires de surface les plus divers, nous offrons à nos clients une liberté d'aménagement maximale. Et si vous ne trouvez pas la forme et la taille adéquates pour votre projet, contactez-nous! PLANLICHT se considère comme un prestataire de solutions. Et en tant que tel, nous n'hésitons pas à en faire plus.



LIGHTING MEETS RAL

Bei PLANLICHT helfen wir mit, Architektur-Träume zu verwirklichen. Deshalb wird Farbkompetenz in unserem Haus seit Jahren groß geschrieben. Über unsere angeführten Standardfarben hinaus sind nahezu alle unsere Produkte in den RAL-Farben erhältlich. Darüber hinaus fertigen wir Ihre Leuchten auch nach Ihren ganz individuellen Farbwünschen.

At PLANLICHT, we help to make architectural dreams come true. That's why colour expertise has been a top priority in our company for years. In addition to our listed standard colours, almost all our products are available in RAL colours. In addition, we can also manufacture your luminaires according to your very own individual colour requirements.

Chez PLANLICHT, nous vous aidons à réaliser vos rêves architecturaux. C'est pourquoi, notre entreprise attache depuis des années une grande importance à la compétence en matière de couleurs. Tous nos produits sont non seulement disponibles dans nos couleurs standard mentionnées, mais sont aussi presque tous proposés dans les couleurs RAL. De plus, nous fabriquons vos luminaires dans la couleur que vous souhaitez.

LIGHT DESIGN MEETS JEWELLERY

Mit den einzigartigen Effektfarben von PLANLICHT wird die Besonderheit offensichtlich: Die hochwertigen Effekt-Oberflächen in matten oder hochglänzenden Gold-, Silber und Kupfer-Tönen machen unsere Leuchten zu einem richtigen Schmuckstück.

With the unique effect colours from PLANLICHT, the distinctiveness of the product becomes obvious: the high-quality, Effect surfaces in matt or high-gloss gold, silver and copper tones makes our luminaire a real gem.

Avec les couleurs à effets exceptionnelles de PLANLICHT, l'originalité est évidente : les surfaces à effets haut de gamme dans les tons or, argent ou cuivre mats ou brillants font de nos luminaires de véritables bijoux.



COLOUR MEETS CABLES

Die Liebe zum Detail kennt bei PLANLICHT keine Grenzen. Deshalb endet für uns Individualisierung nicht bei unterschiedlichen Formen, Größen und Gehäusefarben. Unsere optionalen Textilkabel sind in unterschiedlichsten Farben erhältlich und machen die Leuchte zu einem echten Hingucker.

At PLANLICHT, attention to detail knows no boundaries. That's why, for us, customisation does not end with different shapes, sizes and housing colours. Our optional textile cables are available in a wide variety of colours and turn the luminaire into a really eye-catching piece.

Chez PLANLICHT, l'amour du détail ne connaît aucune limite. C'est pourquoi la personnalisation ne s'arrête pas pour nous aux différentes formes, tailles et couleurs de corps. Nos câbles à gaine textile proposés en option sont disponibles dans les couleurs les plus diverses et font des luminaires un véritable accroche-regard.





LIGHTING COLOUR MEETS RETAIL

Die verkaufsfördernde Gestaltung von Ladenflächen ist eine Kunst für sich. Verschiedene Waren stellen unterschiedliche Anforderungen an die Beleuchtung. Im Modehandel überzeugen die Spezialleuchten von PLANLICHT durch eine kräftige und kontrastreiche Farbwiedergabe. In den unterschiedlichen Bereichen des Lebensmittelhandels regen die verbauten Spezial-LEDs den Konsum an.

The sales-promoting design of shop areas is an art in itself. Different goods place different demands on the lighting. In fashion retail, the special luminaires from PLANLICHT make an impressive statement with their powerful, high-contrast colour rendering. In the different areas of the food retail, the installation of special LEDs stimulates consumption.

La conception promotionnelle des surfaces de vente est un art en soi. Différentes marchandises posent différentes exigences à l'éclairage. Dans les magasins de mode, les luminaires spéciaux de PLANLICHT séduisent par un rendu des couleurs fort et contrasté. Les LED spéciales installées dans les différents espaces des magasins alimentaires incitent à la consommation.



LIGHTING MEETS WORKSPACE

Für die richtige Beleuchtung am Arbeitsplatz sind unterschiedlichste Normen zu beachten. Die speziellen Büroleuchten von PLANLICHT überzeugen durch hohe Lichtleistung und maximalen Sehkomfort. Sie übertreffen vielfach die gesetzlichen Vorgaben und sorgen für eine ideale Ausleuchtung am Schreibtisch.

Correct workplace illumination requires compliance with many different standards. The special office luminaires from PLANLICHT have an impressively high light output and maximum visual comfort. They often go beyond the statutory requirements and provide ideal illumination at the desk.

Les normes les plus diverses doivent être respectées pour garantir un bon éclairage au poste de travail. Les luminaires de bureau spéciaux de PLANLICHT séduisent par leur puissance lumineuse élevée et un confort visuel maximal. Ils dépassent largement les directives légales et garantissent un éclairage idéal au bureau.

LIGHT MEETS ACOUSTIC

Der Mensch im Mittelpunkt. Bei PLANLICHT geht dieser Anspruch über die Lichtwirkung hinaus. Die Akustikleuchten von PLANLICHT absorbieren Umgebungsgeräusche und verwandeln jede Lobby, jedes Großraumbüro, jede Konferenzräumlichkeit in eine echte Wohlfühloase.

The focus is on people. At PLANLICHT, this is a claim that goes beyond the lighting effects. The acoustic luminaires from PLANLICHT effectively absorb ambient noise and transform every lobby, every open-plan office and every conference room into a veritable oasis of well-being.

L'être humain au centre des préoccupations. Chez PLANLICHT, cette exigence va au-delà de l'effet lumineux. Les luminaires acoustiques de PLANLICHT absorbent efficacement les bruits environnants et transforment chaque zone de réception, chaque bureau collectif, chaque salle de conférence en un véritable havre de bien-être.



LIGHTING MEETS HUMAN

Bei PLANLICHT steht der Mensch im Mittelpunkt. Deshalb bieten wir den Großteil unserer Leuchten auch mit dynamischem Weiß an. Das Konzept des Human Centric Lighting passt die Lichttemperatur dem natürlichen Verlauf des Sonnenlichts an und fördert nachweislich die Konzentration und Entspannung.

At PLANLICHT, the focus is on people. That's why we also offer the majority of our luminaires with dynamic white. The concept of Human Centric Lighting adapts the light temperature to the natural course of sunlight and has been proven to promote concentration and relaxation.

Chez PLANLICHT, l'être humain est au centre des préoccupations. C'est pourquoi nous proposons la majorité de nos luminaires également avec un blanc dynamique. Le concept de l'éclairage biodynamique adapte la température de la lumière au cours naturel de la lumière du soleil et promeut la concentration et la détente.





LIGHT MEETS PLANNING

Auf der Suche nach Lösungen?
 Sie suchen die passende Lösung? Sie brauchen Unterstützung für eine ausgetüftelte, normgerechte Beleuchtungsplanung, die Ihre Vision umsetzen kann? Nehmen Sie Kontakt mit uns auf und unsere Planungsabteilung unterstützt und begleitet Sie.

*Looking for solutions?
 Are you looking for the right solution? Do you need help to find a sophisticated, standards-compliant lighting design that can bring your vision to life? Get in touch with us, and our planning department will be happy to offer guidance and support.*

*Vous êtes à la recherche de solutions ?
 Vous êtes à la recherche de la solution adéquate ? Vous avez besoin d'aide pour procéder à une planification d'éclairage ingénieuse et conforme aux normes qui pourra réaliser votre vision ? Contactez-nous. Notre service de planification se fera un plaisir de vous aider et de vous accompagner dans votre projet.*



LIGHT MEETS WALLS

Für die homogene Ausleuchtung von Wänden bieten sich bei PLANLICHT unterschiedliche Möglichkeiten: Von Strahlern mit ovalen Streulinzen bis hin zu Profilen und Profilsystemen mit asymmetrischen Reflektoren.

PLANLICHT offers various options for the homogeneous illumination of walls: from spotlights with oval diffuser lenses to profiles and profile systems with asymmetrical reflectors.

PLANLICHT propose différentes possibilités pour l'éclairage homogène des murs: du spot à lentilles divergentes ovales aux profilés et systèmes de profilé à réflecteurs asymétriques.



FUNCTION MEETS CONTROL

PLANLICHT bietet eine umfassende Palette an Produkten, die eine vollständige Variabilität u. a. in Bezug auf Gehäusefarben, Profillängen, Sensoren, Lichtfarben, Einsätzen sowie smarten Steuerungsmöglichkeiten gewährleisten.

PLANLICHT offers a comprehensive range of products that ensure complete variability concerning housing Colours, profile lengths, sensors, light colours, inserts, and smart control capabilities, among others.

PLANLICHT propose une gamme complète de produits offrant une variabilité totale en ce qui concerne, entre autres, les couleurs des boîtiers, les longueurs de profilés, les capteurs, les couleurs de lumière, les inserts ainsi que les capacités de contrôle intelligent.



LIGHT MEETS SUSTAINABILITY

Nachhaltigkeit ist für PLANLICHT nicht nur ein Schlagwort. So stellt diese mit den **drei Säulen des verantwortungsvollen Handelns** – Umwelt, Mensch und Wirtschaftlichkeit – einen zentralen Aspekt in der Ausrichtung von PLANLICHT dar.

Sustainability is not just a buzzword for PLANLICHT. It's reflected in PLANLICHT's ESG framework - encompassing the pillars of environment, human, and economy.

La durabilité n'est pas simplement un mot à la mode pour PLANLICHT. Elle se reflète dans le cadre ESG de PLANLICHT - englobant les piliers de l'environnement, de l'humain et de l'économie.



UNSER BEITRAG ZUR NACHHALTIGKEIT | FÜR EINE „STRAHLENDERE“ ZUKUNFT

„Nachhaltigkeit in ökologischer und ökonomischer Hinsicht ist für PLANLICHT nicht nur ein Schlagwort.“

- FELICITAS KOHLER, CEO PLANLICHT



PLANLICHT verfolgt einen umfassenden Nachhaltigkeitsansatz, der **ökologische, ökonomische und soziale Aspekte** in sämtlichen Unternehmensbereichen berücksichtigt.

So haben wir bei PLANLICHT es uns zum Ziel gesetzt, den Energieverbrauch von Beleuchtung um ein Vielfaches zu senken. Entsprechend konsequent haben wir uns bereits 2010 für die **ausschließliche Entwicklung von Leuchten mit LED-Technologie** entschieden. Fortlaufend minimieren wir den Energieverbrauch unserer Produkte durch neueste LED-Technologie und Maximierung der Leuchtwirkung mit Hilfe spezieller Optiken.

Leuchten von PLANLICHT überzeugen neben ihrer Energieeffizienz auch durch ihre **besonders hohe Qualität und Produktlebensdauer**. Für dieses Wertversprechen verbürgen wir uns mit unserer exklusiven „Garantie 66“. Selbst für den unwahrscheinlichen Fall, dass eine Leuchte nicht mehr funktionieren sollte, ist vorgesorgt: So wird bei PLANLICHT jedes Produkt von Beginn an so konstruiert, dass es sich einfach reparieren lässt. Die neue **„green-Produktlinie“** zielt zudem darauf ab, kontinuierlich Umweltauswirkungen zu reduzieren und den CO₂-Fußabdruck zu optimieren.

PLANLICHT achtet auch bei Themen wie **Verpackung und Abfall** auf die Umwelt. Wir verzichten über die gesamte Wertschöpfungskette weitgehend auf Kunststoffe in der Verpackung und setzen zunehmend Mehrwegverpackungen ein. Ressourcenschonung wird auch durch die Förderung **lokaler Partnerschaften** und **kurze Transportwege** vorangetrieben.

Die lokale, nachhaltige Produktion wird in der **CO₂-reduzierten Produktionsstätte** PLANFACTORY umgesetzt, in der wir auf höchste Gebäudeeffizienz und Energiegewinnung aus erneuerbaren Energien wie Photovoltaik und Holz-Hackschnitzelanlagen setzen.

So trägt PLANLICHT einen Beitrag zu einer nachhaltigeren Zukunft.

OUR CONTRIBUTION TO SUSTAINABILITY | FOR A ,BRIGHTER' FUTURE

PLANLICHT pursues a comprehensive sustainability approach that considers ecological, **economic, and social aspects** across all areas of the company. At PLANLICHT, we have set ourselves the goal of significantly reducing lighting energy consumption. Accordingly, we made a steadfast decision in 2010 to **exclusively develop lighting solutions based on LED technology**. Continuously, we enhance the energy efficiency of our products through the latest LED technology and by maximizing light output using specialized optics.

Besides their energy efficiency, PLANLICHT luminaires are known for their **exceptional quality and extended product lifespan**. We stand behind this commitment with our exclusive ,Guarantee 66.' Even in the unlikely event of a malfunction, we ensure preparedness: Every product from PLANLICHT is designed

to be easily repairable.

The new ,green product line' also aims to continually reduce environmental impacts and optimize the CO₂ footprint.

At PLANLICHT, attention to environmental concerns extends to **packaging and waste**. We largely avoid plastics throughout the entire value chain and increasingly adopt reusable packaging.

We further promote resource conservation through fostering **local partnerships and shorter transport routes**.

Our sustainable local production takes place at the **CO₂-reduced production facility**, PLANFACTORY, where we emphasize maximum building efficiency and utilize renewable energies such as photovoltaics and wood chip heating systems.

PLANLICHT thus contributes to a more sustainable future.

NOTRE CONTRIBUTION À LA DURABILITÉ | POUR UN AVENIR PLUS ,RADIEUX'

PLANLICHT adopte une approche globale de durabilité qui prend en compte **les aspects écologiques, économiques et sociaux** dans tous les domaines de l'entreprise.

Chez PLANLICHT, notre objectif est de réduire de manière significative la consommation d'énergie pour l'éclairage. En conséquence, nous avons pris la décision ferme en 2010 de **développer exclusivement des solutions d'éclairage basées sur la technologie LED**. Nous améliorons continuellement l'efficacité énergétique de nos produits grâce aux dernières avancées technologiques en matière de LED et en maximisant la luminosité à l'aide d'optiques spécialisées.

Outre leur efficacité énergétique, les luminaires de PLANLICHT sont réputés pour **leur qualité exceptionnelle et leur durée de vie prolongée**. Nous soutenons cet engagement avec notre exclusivité, la ,Garantie 66'. Même en cas de dysfonctionnement peu probable, nous garantissons une préparation : chaque produit de PLANLICHT est conçu pour être facilement réparable.

La nouvelle **ligne de produits ,green'** vise également à réduire continuellement les impacts environnementaux et à optimiser l'empreinte carbone.

Chez PLANLICHT, la prise en compte des préoccupations environnementales s'étend à **l'emballage et aux déchets**. Nous évitons largement les plastiques tout au long de la chaîne de valeur et adoptons de plus en plus des emballages réutilisables. Nous favorisons également la conservation des ressources en encourageant les partenariats locaux et en réduisant les trajets de transport.

Notre production locale durable se déroule dans l'installation de **production réduisant le CO₂**, PLANFACTORY, où nous mettons l'accent sur une efficacité maximale des bâtiments et utilisons des énergies renouvelables telles que le photovoltaïque et les systèmes de chauffage aux copeaux de bois.

PLANLICHT contribue ainsi à un avenir plus durable.

PURE 3.GREEN



UNSER PRODUKTPORTFOLIO | PREMIUM-MARKEN FÜR IHRE PROJEKTE



#LIGHTMEETSARCHITECTURE

Das Leuchtersortiment bei PLANLICHT könnte nicht vielseitiger sein! Vom minimalistischen Downlight über visuell ansprechende Flächenleuchten bis hin zum multifunktionalen Profilsystem bieten wir unseren Kund:innen maximale Freiheit bei der Gestaltung. Sollten Sie dennoch nicht auf die gewünschte Form, Größe oder Farbe für Ihr Projekt stoßen, finden unsere Lichtexpert:innen sicherlich eine passende, maßgeschneiderte Lösung für Sie.

Neben den PLANLICHT-Produkten bieten wir Ihnen auch andere sortimentserweiternde Premiummarken.

OUR PRODUCT PORTFOLIO | PREMIUM BRANDS FOR YOUR PROJECTS

The range of luminaires at PLANLICHT couldn't be more diverse! From minimalist downlights to visually appealing panel lights and multifunctional profile systems, we offer our customers maximum freedom in design. If, however, you can't find the desired shape, size, or color for your project, our lighting experts will surely find a suitable, tailored solution for you.

In addition to PLANLICHT products, we also offer other premium brands that expand our range.

NOTRE PORTEFEUILLE DE PRODUITS | MARQUES PREMIUM POUR VOS PROJETS

La gamme de luminaires chez PLANLICHT est d'une polyvalence remarquable ! Du downlight minimaliste aux éclairages de surface visuellement attrayants en passant par les systèmes de profilés multifonctionnels, nous offrons à nos clients une liberté maximale en matière de conception. Si, toutefois, vous ne trouvez pas la forme, la taille ou la couleur souhaitée pour votre projet, nos experts en éclairage trouveront certainement une solution sur mesure adaptée à vos besoins.

En plus des produits PLANLICHT, nous vous proposons d'autres marques premium qui élargissent notre gamme.



ALMUT

VON WILDHEIM

organic lamps

#LIGHTMEETS NATURE

ALMUT von Wildheim design und produziert Leuchten aus natürlichen Materialien, die eine besondere Atmosphäre schaffen. Inspiriert von der Heimat der Unternehmensgründer, den Tiroler Bergen, werden handgemachte Leuchten aus Naturmaterialien wie heimische Hölzer, pures Heu, Blüten, Stein, Merino-Woolfilz und viele mehr erzeugt.

ALMUT von Wildheim designs and produces lights from natural materials, creating a special atmosphere. Inspired by the founders' homeland, the Tyrolean mountains, handcrafted luminaires are made from natural materials such as local woods, pure hay, blossoms, stone, Merino wool felt, and many more.

ALMUT von Wildheim conçoit et fabrique des luminaires à partir de matériaux naturels, créant ainsi une atmosphère particulière. Inspirés par la terre natale des fondateurs de l'entreprise, les montagnes du Tyrol, des luminaires artisanaux sont fabriqués à partir de matériaux naturels tels que des bois locaux, du foin pur, des fleurs, de la pierre, de la feutrine de laine mérinos, et bien d'autres.



seTup.lighting

VISIBLE EMOTIONS

#LIGHTMEETSWOOD

Die **Setup.Lighting**-Manufaktur entwirft, entwickelt und produziert einzigartige Licht-Lösungen aus Holz, Metall sowie innovativer LED-Technologie und lässt mit den einzigartigen Designs maßgeschneidert auf Kundenbedürfnisse keine Wünsche offen. Setup.Lighting: Innovative Lichtlösungen aus Massivholz so individuell wie Ihr Fingerabdruck!

The Setup.Lighting manufacture designs, develops, and produces unique lighting solutions from wood, metal, and innovative LED technology, providing custom designs tailored to meet customer needs. Setup.Lighting: Innovative lighting solutions in solid wood, as individual as your fingerprint!

La Manufacture Setup.Lighting conçoit, développe et produit des solutions lumineuses uniques en bois, en métal et avec une technologie LED innovante, offrant des designs personnalisés répondant aux besoins des clients. Setup.Lighting : Des solutions lumineuses innovantes en bois massif aussi uniques que votre empreinte digitale !

PLANLICHT GROUP | DIE GEBALLTE KRAFT

PLANLICHT entwickelt sich konsequent weiter, unter anderem durch die kontinuierlich wachsende PLANLICHT GROUP.

Im Jahr 2020 wurde in Zusammenarbeit mit dem MCI das Startup **CARE BY LIGHT** gegründet: Mit technologischer und wissenschaftlicher Expertise werden Desinfektionsgeräte zur rückstandslosen & chemiefreien Reinigung von Gegenständen und Raumluft von Viren, Bakterien und Pilzen entwickelt, produziert und vermarktet.

2021 beteiligte sich PLANLICHT am Tiroler Startup **ALMUT von Wildheim**, welches sich mit der nachhaltigen Herstellung von Design-Leuchten aus natürlichen Materialien – wahren Eyecatchern passend zum Lifestyle – beschäftigt.

Anfang 2023 lief der Vollbetrieb der **PLANFACTORY** – 100% im Besitz von PLANLICHT – im steirischen Murau an. Als Komplettanbieter bietet PLANFACTORY unterschiedlichste Technologien für den gesamten Dünnblechbereich, der Pulverbeschichtung bis hin zur Montage von komplexen mechanischen und elektrischen Baugruppen an.

PLANLICHT GROUP | THE COLLECTIVE POWER

PLANLICHT is consistently evolving, notably through the continuous expansion of the PLANLICHT GROUP.

In 2020, the startup **CARE BY LIGHT** was established in collaboration with MCI: leveraging technological and scientific expertise to develop, produce, and market disinfection devices for residue-free and chemical-free cleaning of objects and indoor air from viruses, bacteria, and fungi.

In 2021, PLANLICHT made an investment in the Tyrolean startup **ALMUT von Wildheim**, which specializes in crafting sustainable design lamps from natural materials. These luminaires are considered true eye-catchers that resonate with various lifestyle choices.

At the beginning of 2023, the full operation of PLANFACTORY - 100% owned by PLANLICHT - commenced in Murau, Styria. As a complete provider, **PLANFACTORY** offers various technologies for the entire thin sheet metal sector, including powder coating and assembly of complex mechanical and electrical components.



PLANLICHTGROUP

PLANLICHT GROUP | LA FORCE COLLECTIVE

PLANLICHT évolue constamment, notamment grâce à l'expansion continue du groupe PLANLICHT.

En 2020, en collaboration avec MCI, PLANLICHT a lancé la startup **CARE BY LIGHT**: exploitant une expertise technologique et scientifique pour développer, produire et commercialiser des dispositifs de désinfection permettant un nettoyage sans résidus et sans produits chimiques d'objets et d'air intérieur, en éliminant virus, bactéries et champignons.

En 2021, PLANLICHT a investi dans la startup tyrolienne **ALMUT von Wildheim**, spécialisée dans la fabrication de lampes design durables à partir de matériaux naturels. Ces luminaires sont considérés comme des pièces uniques qui correspondent à différents styles de vie.

Au début de 2023, **PLANFACTORY**, entièrement détenue par PLANLICHT, a démarré ses opérations à Murau, Styrie. En tant que fournisseur complet, PLANFACTORY propose diverses technologies pour l'ensemble du secteur des feuilles de métal minces, comprenant notamment le revêtement en poudre et l'assemblage de composants mécaniques et électriques complexes.



„Mit unserem neuen Fertigungs-Standort verwirklichen wir die Vision einer CO2-neutralen Produktion.“

Gerald Kohler - Chief Operating Officer

„With our new manufacturing facility, we are realizing the vision of a CO2-reduced production.“

„Avec notre nouvelle installation de production, nous concrétisons la vision d'une production à faible émission de CO2.“



„Unsere Technologie ermöglicht die effektive Desinfektion rückstandslos, ganz ohne Chemikalien.“

Andreas Mühlthaler - Product Management

„Our technology enables effective residue-free disinfection, entirely without chemicals.“

„Notre éclairage va bien au-delà de l'illumination des espaces, de la création d'ambiance et de l'influence sur les humeurs humaines.“

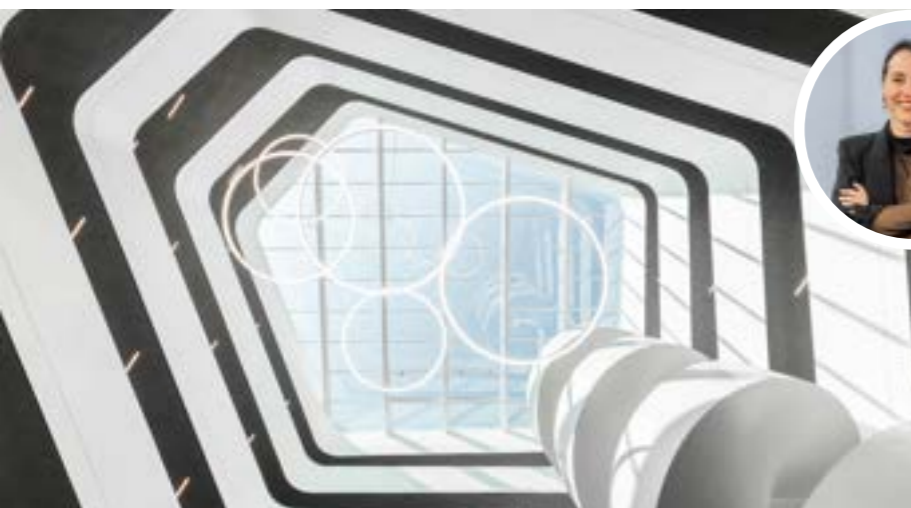

„Unser Licht kann noch viel mehr als Räume erhellen, Atmosphäre schaffen und die menschliche Stimmung beeinflussen.“

Felicitas Kohler - CEO PLANLICHT

„Our lighting can do much more than illuminate spaces, create ambiance, and influence human moods.“

„Notre éclairage va bien au-delà de l'illumination des espaces, de la création d'ambiance et de l'influence sur les humeurs humaines.“



„Inspiriert von den Bergen verwenden wir zur Fertigung unserer Design-Leuchten natürliche Materialien aus der Umgebung.“

Ulrich Huber - Co-Founder Almut

„Inspired by the mountains, we use natural materials from the surroundings for manufacturing our design lamps.“

„Inspirés par les montagnes, nous utilisons des matériaux naturels de l'environnement pour la fabrication de nos lampes design.“

Produktneuigkeiten im Überblick

Product news overview | Vue d'ensemble des nouveautés produits

34

Ausgewählte Produkthighlights

Selected product highlights | Points forts des produits sélectionnés

36

PRODUKTNEUIGKEITEN IM ÜBERBLICK

Als Experten im Technologiebereich stehen bei PLANLICHT Forschung, Entwicklung und Innovation an der Tagesordnung. So werden mehrmals jährlich Produktfamilien-Erweiterungen und innovative Highlights lanciert.

Welche Neuerungen wurden seit dem Erscheinen des letzten Katalogs vorgestellt?

PRODUCT NEWS

Being specialists in the technology field, conducting research, development, and fostering innovation are standard procedures for PLANLICHT. We consistently introduce expansions to our product lines and innovative features multiple times throughout the year.

What recent updates have been presented since the last catalogue was released?

NOUVEAUTÉS PRODUITS

En tant qu'experts dans le domaine de la technologie, la recherche, le développement et l'innovation font partie intégrante de notre quotidien. Nous lançons régulièrement des extensions de gammes de produits et des points forts innovants plusieurs fois par an.

Quelles nouveautés ont été introduites depuis la parution du dernier catalogue ?



P.THIRTY

- p.thirty Jet Black Microprism
- p.thirty Opto-Balance Darklight® (OBD) inkl. Office Special
- p.thirty Einbauvarianten | *Recessed*
- Lichtfarbe 840 im Standard | *Light colour*
- sinus p.thirty (hängende Ringleuchte) | *Ring luminaire (pendant)*
- Neue Optik: Jet Black & Light
- zenit XXS Spots- und Hängeleuchten-Segmente für p.thirty | *Segments with spots & pendants*



P.FORTY

- p.forty shapes + quiet
- p.forty fusion
- p.forty seven
- Neue Optik: Jet Black & Light

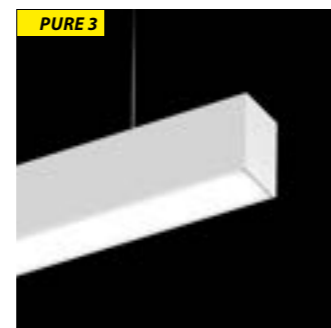

PURE 3

- pure 3.green
- pure 3 shapes + quiet
- pure 3 fusion
- Neue Optik: Jet Black & Light
- Sanierungskits für pure 1 & pure 2 | *Refurbishment kits*



QUADRO

- quadro.green
- Neue Optik: PLF-Raster (Parabolic Louvre F-type semi matte) | *PLF louvre*
- Neue Raster-Farbe: High Gloss Black Chrome | *Louvre colour*

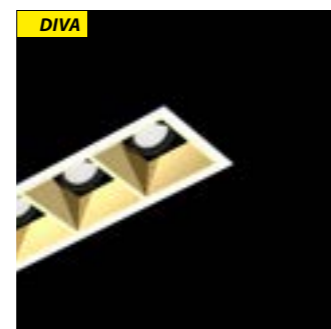

DIVA

diva S square multiple

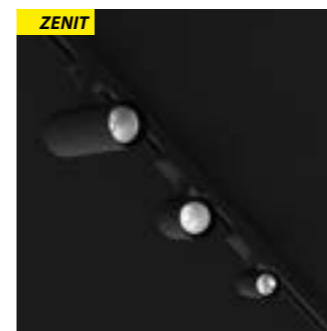

ZENIT

- zenit XXS Spots- und Hängeleuchten-Segmente für p.thirty | *Segments with spots & pendants*
- zenit XXS Hängeleuchten | *Pendant*
- zenit M Hängeleuchte | *Pendant*
- zenit M Einbauvarianten | *Recessed*
- zenit M Tubusfarben inkl. High Gloss Black Chrome | *Tube colours*



FLÄCHENLEUCHTEN |
SURFACE LUMINAIRES

- 3-Phasen Track-Adapter für Flächenleuchten (klein) | *Adapter for small surface luminaires*
- ophelia Einbauvariante inkl. optionalem Effizienz-Booster | *Recessed*
- Optik „Extra Comfort“ für odelia, olmo, ophelia



RINGLEUCHTEN |
RING LUMINAIRES

- sqing Aufbauvariante | *Surface*
- p.thirty Opto-Balance Darklight® (OBD) inkl. Office Special
- sinus p.thirty Hängeleuchte | *Ring luminaire (pendant)*
- halo Hängeleuchte in neuer Größe 450mm | *Pendant in new size*



NEUE BESCHICHTUNGSFARBE |
NEW COLOUR

High Gloss Black Chrome für anto+, zenit & quadro | High Gloss Black Chrome for anto+, zenit & quadro

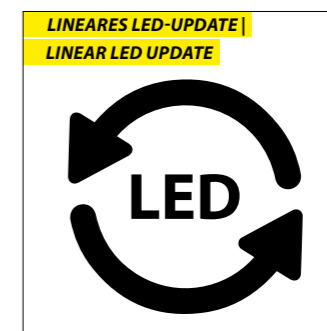

LINEARES LED-UPDATE |
LINEAR LED UPDATE

Lineares LED-Update CRI > 90, minimierter Effizienzunterschied: 940/840 ca. 1-2%, 930/830 ca. 4-7% | *Linear LED update CRI > 90, reduced difference in efficiency 940/840 about 1-2%, 930/830 about 4-7%*

Erfahren Sie auf den nächsten Seiten mehr über ausgewählte Produktneuheiten.
Learn more about selected product innovations on the following pages.
Apprenez-en davantage sur les innovations de produits sélectionnés.

NEUE OPTIKEN FÜR P.THIRTY



EINE KLEINE PROFILLEUCHE SCHREIBT GROSSE GESCHICHTEN.

KLEIN, ABER KRAFTVOLL

p.thirty ist das kleinste der PLANLICHT Profileuchten und überzeugt mit einem minimalistischen Design und großer Variabilität. Eine herausragende Leistung, hoher Sehkomfort und integrierte Betriebsgeräte sind selbstverständlich.

SMALL PROFILE LUMINAIRE WRITES HUGE STORIES.

SMALL BUT POWERFUL

p.thirty is the smallest of the PLANLICHT profile luminaires and impresses with a minimalist design and great variability. Great performance, high eye comfort and an integrated driver go without saying.

JET-BLACK-MIKROPRISMATISCH

Der spezielle Diffusor in der Farbe Jet Black Mikroprisma verleiht der Leuchte einen außergewöhnlichen Look.

JET BLACK MICROPRISM

The special diffuser colour Jet Black Mikroprisma provides an extraordinary look.



P.THIRTY OPTO-BALANCE DARKLIGHT® | KOMPROMISSLOS PUNKTGENAU

p.thirty Opto-Balance Darklight® besticht durch die zonierte Lichtausgabe, ihre extrem kleinen Abmessungen und mit integriertem Betriebsgerät trotz der ausgeklügelten Lichtlenkungstechnologie.

Durch die Bündelung des Raumlichtes wird die zu beleuchtende Fläche optimal erhellt und das Licht landet exakt dort, wo es gewünscht ist. Kompromisslos punktgenau.

Zudem weist die neue OBD-Variante in allen Montagearten auch

rein direkt strahlend und in jeglicher Bestromung einen UGR-Wert unter 16 auf und sorgt somit für normkonformen Sehkomfort. In der Variante als Hängeleuchte mit direkt/indirekter Lichtabgabe liegt der Blendwert sogar unter 6 – einem sagenhaft niedrigen Wert, der selbst in den gängigsten Beleuchtungsfibern nicht abgebildet wird.

Die Spezialausführung „office special“ überzeugt zusätzlich durch die Reduktion der Wartungs- und Betriebskosten.

P.THIRTY OPTO-BALANCE DARKLIGHT® | UNCOMPROMISINGLY SPOT-ON

p.thirty Opto-Balance Darklight® (OBD) impresses with its zoned light output, its extremely small dimensions and with an integrated driver despite its sophisticated light focusing technology. By concentrating the light output, the respective workspace surface is optimally illuminated and no light is wasted, as it arrives exactly where it is needed. Uncompromisingly precise and spot-on.

In addition, the new OBD version has an UGR value of less than 16 in all mounting types, all output versions and even with solely direct light distribution, thus ensuring visual comfort according to unified standards. As a pendant luminaire with direct/indirect light output, the glare value is even below 6 – a value so low that it is not even mentioned in most literature about lighting design.

VORTEILE

- Optimal ausbalanciertes Licht
- Innovative Lichttechnologie
- Maximaler Sehkomfort
- Minimalistisches Design & Größe
- Trendige metallische Optikbeschichtungen

BENEFITS

- Optimally balanced light
- Innovative lighting technology
- Maximum visual comfort
- Minimalist design & size
- Trendy metallic reflector coatings

ZENIT XXS

SEGMENTE & HÄNGELEUCHTEN



ZENIT XXS | ENDLOSE VIELFALT, ELEGANTE LEICHTIGKEIT

Die zenit-Familie darf sich über Verstärkung freuen – mit den zenit XXS-Spots präsentiert PLANLICHT den bisher kleinsten zenit-Spot mit einem Durchmesser von nur 31 mm. Dieses winzige Kraftpaket bietet eine bemerkenswerte Vielseitigkeit und ermöglicht die ideale Raumbeleuchtung:

Farben: zenit XXS ist nicht nur leistungsstark, sondern auch ästhetisch ansprechend und in vier verschiedenen Farboptionen erhältlich: Schwarz, Weiß, Silber und Aluminium (im schwarzen Profil/mit schwarzem Baldachin).

Ausstrahlwinkel: Dank der hochwertigen asphärischen Glaslinse wird das perfekte Licht garantiert und die Wahl zwischen engem

und breitem Strahlungswinkel bietet zudem die Möglichkeit der individuellen Raumbeleuchtung.

AUSFÜHRUNGEN:

- Segment für p.thirty-Profilserie mit 1 – 5 Spots
- Segment für p.thirty-Profilserie mit 1 oder 2 Pendants
- Hängeleuchte Balken mit 2 oder 4 Pendants
- Hängeleuchte rund mit 1, 3 oder 5 Pendants

Die unendlichen Möglichkeiten der zenit-Familie mit den neuen zenit XXS Spots – für eine Beleuchtung, die nicht nur funktional, sondern auch ästhetisch ansprechend ist.

ZENIT XXS | ENDLESS VARIETY, ELEGANT LIGHTNESS!

The zenit family welcomes a new addition – with the zenit XXS, PLANLICHT introduces the smallest zenit spotlight to date with a diameter of only 31 mm. This tiny powerhouse offers remarkable versatility, enabling perfect illumination of every corner of the room:

Colours: zenit XXS is not only powerful but also aesthetically pleasing, available in four different colour options: black, white, silver, and aluminium (in black profile/with black canopy).

Beam Angle: Thanks to the high-quality aspherical glass lens, perfect light is guaranteed, and the choice between narrow and wide beam angles allows for individual room lighting options.

VARIANTS:

- Segment for p.thirty profile series with 1 – 5 spots
- Segment for p.thirty profile series with 1 or 2 pendants
- Pendant bar suspension light with 2 or 4 pendants
- Round pendant suspension light with 1, 3, or 5 pendants

Explore the endless possibilities of the zenit family with the new zenit XXS spots – for lighting that is not only functional but also aesthetically pleasing.



EFFEKTFARBEN IM METALLIC-LOOK

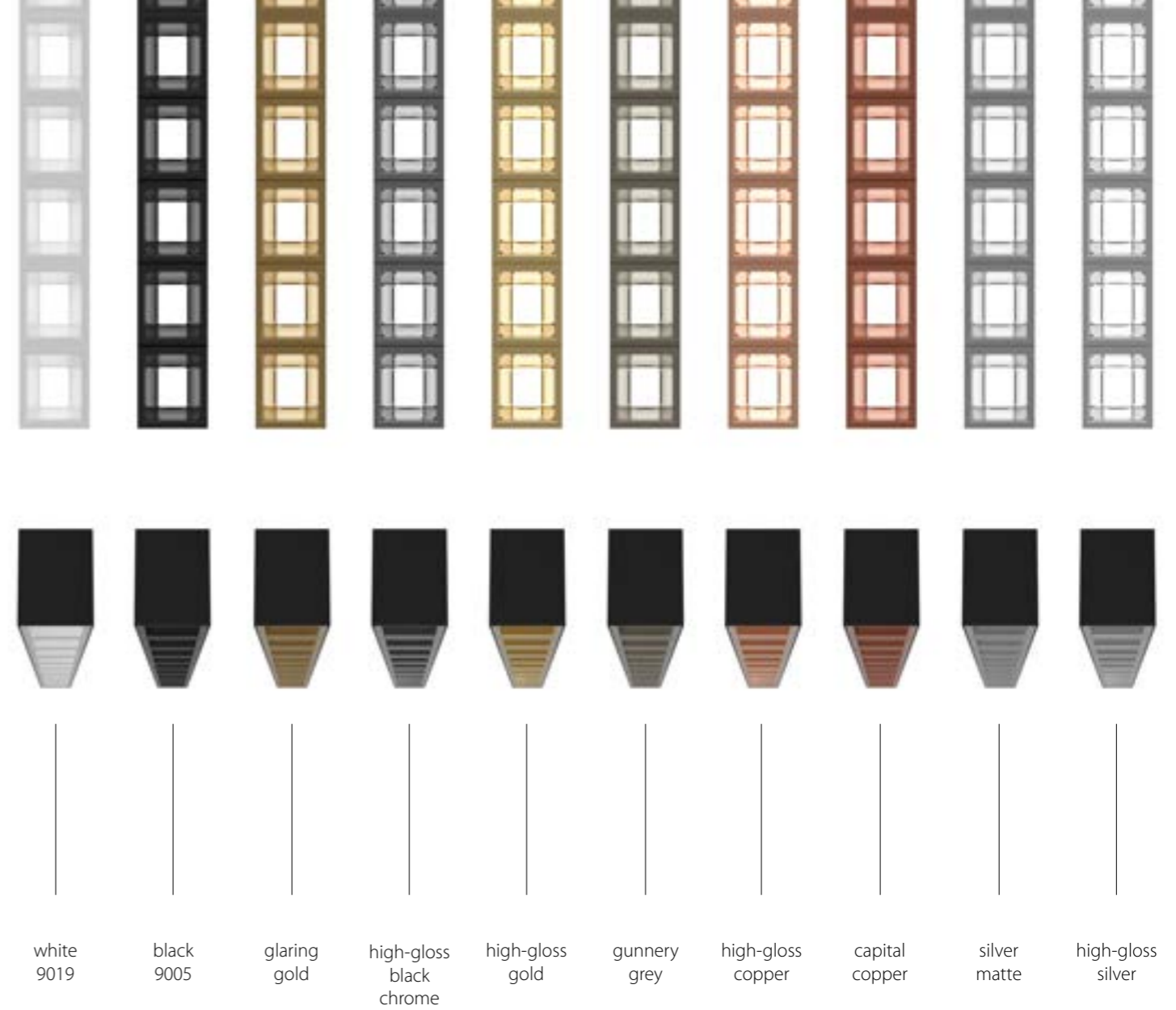
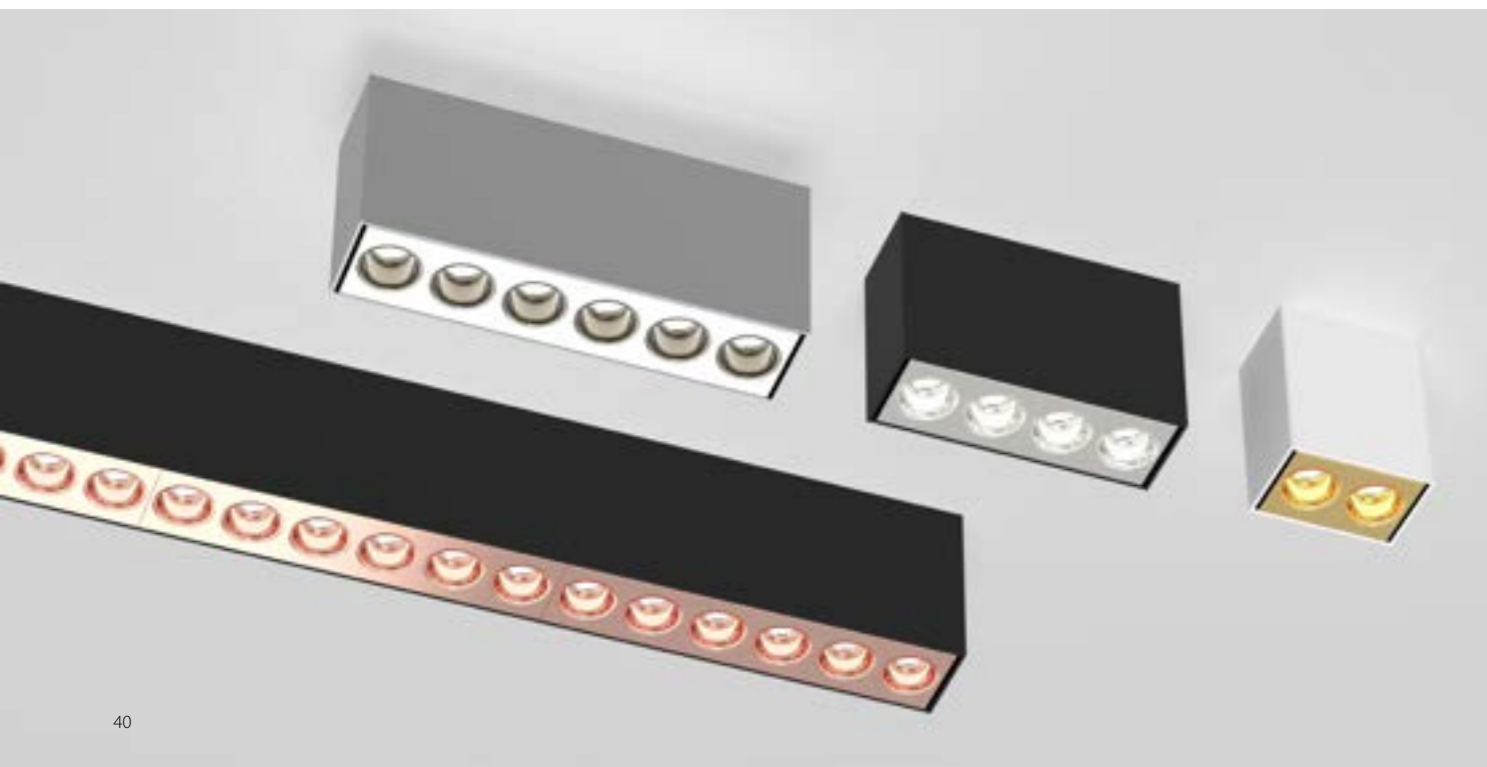

Mit den Farben im Metallic-Look – in glänzenden „high gloss“ und matten Varianten – wird jede Leuchte zum Blickfang. Die neue Farbe „high gloss black chrome“ ergänzt das bestehende Farbsortiment.

Die Farboptionen sind (teilweise) für die folgenden Produktfamilien verfügbar:

- anto+:** Maske & Tubus
- quadro:** BAP-Raster
- p.thirty:** Opto-Balance Darklight® (OBD) Raster
- zenit M:** Tubus/Zierring
- p.forty:** anto+ Einsätze (Maske & Tubus)
- pure 3:** anto+ Einsätze (Maske & Tubus)

With colors in a metallic appearance – in high gloss and matte variations – every luminaire becomes an eye-catcher. The new color, high gloss black chrome' complements the existing color range.

The color options are (partially) available for the following product families:

- anto+:** mask & tube
- quadro:** louvre
- p.thirty:** Opto-Balance Darklight® (OBD)
- zenit M:** tube
- p.forty:** anto+ insets (mask & tube)
- pure 3:** anto+ insets (mask & tube)

NEUE SHAPES & QUIET VERSIONEN FÜR P.FORTY & PURE 3

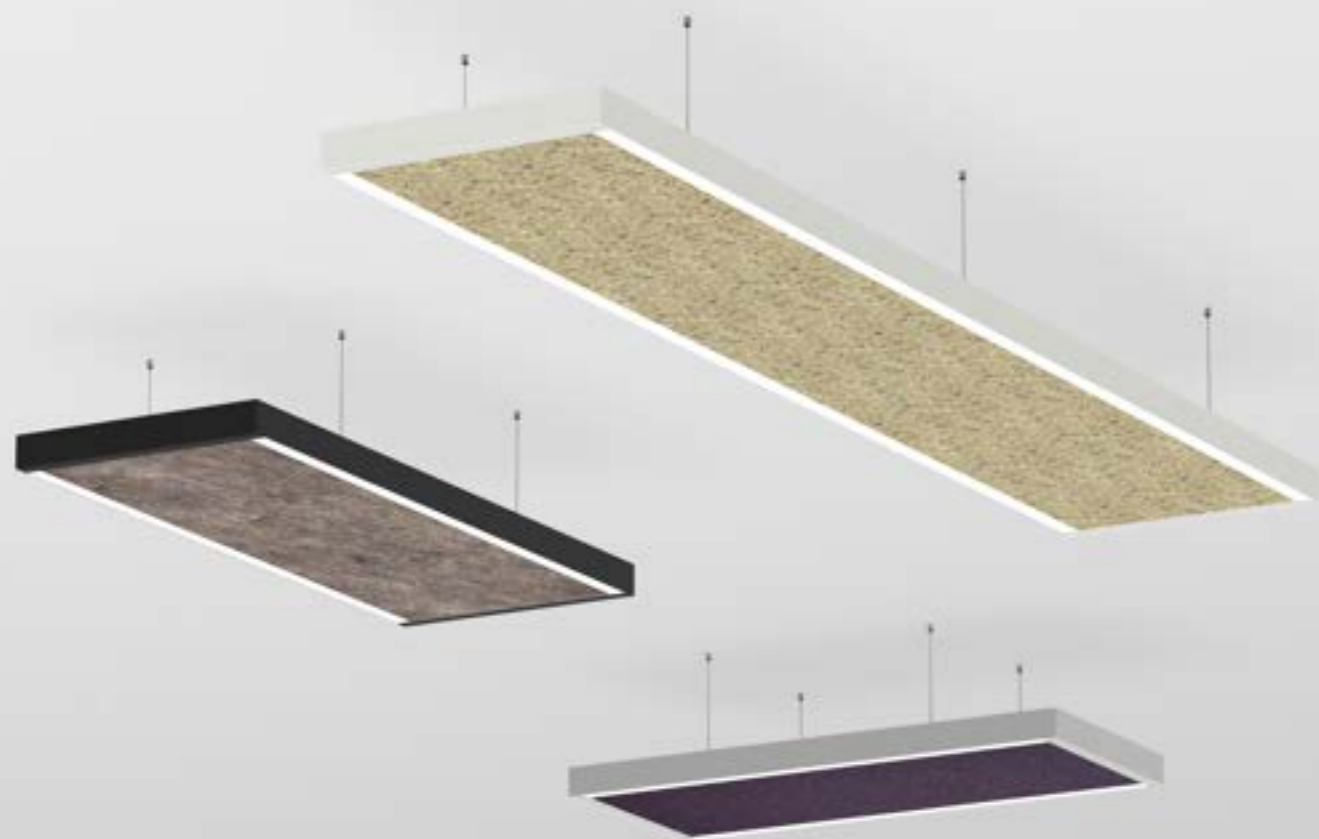

P.FORTY.QUIET & PURE 3.QUIET

ERWEITERUNG DER „QUIET“-LINIE

Die PLANLICHT „quiet“-Linie – bisher erhältlich für die Ringleuchte sinus und die Profilleuchte quadro – freut sich über eine Erweiterung: Ab sofort gesellen sich auch die

Profilleuchten pure 3 und p.forty dazu und sorgen neben der perfekten Beleuchtung auch für die ideale Raumakustik.

P.FORTY.QUIET & PURE 3.QUIET

EXTENSION OF THE „QUIET“ LINE

The PLANLICHT „quiet“ product line, which has so far been available for the sinus ring luminaire and the quadro profile luminaire, has been extended: the pure 3 and p.forty profile luminaires have

now been added to the line, providing not only perfect lighting but also ideal room acoustics.



SHAPES FÜR PURE 3 & P.FORTY

DIE PERFEKTE FORM FÜR IHR PROJEKT

Die Profilleuchten **pure 3** & **p.forty** bringen nicht nur in der linearen Variante (pure 3 zudem als Kreis oder Kurve) jeden Raum zum Strahlen – sie machen jetzt auch als Quadrat oder

Hexagon designt eine gute Figur. Damit aber nicht genug: Als Systemlösung können die beiden Profile komplett individuell geplant und zu jeder erdenklichen Form konfiguriert werden.

“SHAPES“ FOR PURE 3 & P.FORTY

THE PERFECT SHAPE FOR YOUR PROJECT

The profile luminaires pure 3 & p.forty not only illuminate every space flawlessly in their linear form (pure 3 is also available in circle or curve shapes) – they now also make a statement as a

square or hexagon design. But that's not all: As a system solution, these two profiles can be entirely customized and configured into any imaginable shape.

NEUE GREEN-LINIE



PURE 3.GREEN & QUADRO.GREEN DIE PROFILLEUCHTEN MIT DEM REDUZIERTEN CO2-FUSSABDRUCK

PLANLICHT setzt auch in Bezug auf die bei der Leuchten-Produktion eingesetzten Materialien auf Nachhaltigkeit.

Die neue green-Linie nutzt das umweltfreundliche „Hydro REDUXA“-Aluminium: „Low Carbon“ Aluminium, das einen geringeren Kohlendioxid-Fußabdruck aufweist.

Durch den Einsatz von erneuerbaren Energiequellen wie Wasserkraft, Wind und Sonne in Kombination mit einer hocheffizienten Elektrolysetechnologie wird bei der Herstellung von Hydro REDUXA maximal 4,0 kg CO₂ pro kg Aluminium freigesetzt. Dies ist nur ein Viertel des weltweiten Durchschnitts und ein wichtiger Schritt in Richtung einer nachhaltigeren Zukunft.

Nicht nur ist Hydro REDUXA von der DNV-GL nach ISO 14064 verifiziert, es ist auch durch eine Umwelt-Produkt-Deklaration bestätigt.

Eine bewusste, umweltfreundlicher Materialwahl für eine nachhaltige Zukunft.

PURE 3.GREEN & QUADRO.GREEN THE PROFILE LUMINAIRES WITH A REDUCED CO₂ FOOTPRINT

PLANLICHT also focuses on sustainability when it comes to the materials used in the production of luminaires and lighting solutions.

The new green product line uses more environmentally friendly „Hydro REDUXA“ aluminium: low carbon aluminium, which has a reduced carbon footprint.

By using renewable energy sources such as hydropower, wind, and solar power in combination with highly efficient electrolysis technology, the production of Hydro REDUXA emits a maximum of 4.0 kg CO₂ per kg of aluminium. This equals only a quarter of the global average and is an important step towards a more sustainable future.

Not only is Hydro REDUXA verified according to ISO 14064 by DNV-GL, it is also endorsed by an environmental product declaration.

A conscious, environmentally friendly material choice für a sustainable future.



PROFILLEUCHTEN | *PROFILE LUMINAIRES* | *LUMINAIRES PROFILÉS*

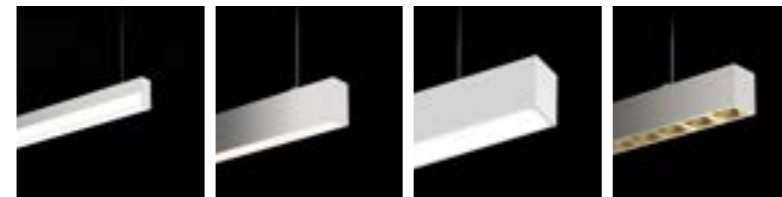

P.THIRTY
49

P.FORTY
57

PURE 3
65

QUADRO
73

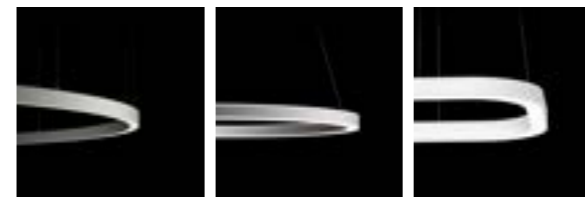

SINUS
81

HALO
89

SQING
97

FLÄCHENLEUCHTEN | *AREA LUMINAIRES* | *LAMPES DE SURFACE*



OPHELIA
103

ODELIA
111

LILIBET
119

OLMO
123

SKAI
131

DOWNLIGHTS & STRAHLER | *DOWNLIGHTS & SPOTLIGHTS* | *DOWNLIGHTS & PROJECTEURS*



ANTO+
139

ZENIT
147

DIVA
155



MINIMALISTISCHES PROFIL

Eine Profilbreite von nur 31 mm.

*Minimalistic profile
Profil minimaliste*



HOHE LICHTLEISTUNG

Grund- und Arbeitsplatzbeleuchtung

*High performance
Haute puissance lumineuse*



HOHER SEHKOMFORT

Homogene Opal-Diffusoren und blendfreie Mikroprismen.

*Eye comfort
Confort visuel élevé*



INTEGRIERTES VORSCHALTGERÄT

Triber immer vollständig im Profilgehäuse integriert.

*Driver integrated
Ballast intégré*

SPRITZWASSERGESCHÜTZT

Erhältlich in der IP44-Version für Badezimmer.

*Splash water proof
Protégée contre les projections d'eau*



MODULARE SYSTEMLÖSUNG

Verbindung von Modulen, um individuelle Beleuchtungslösungen zu schaffen.

*Modular system
Solution système modulaire*



BELEUCHTETE ENDKAPPEN

U-förmige Diffusoren können mit beleuchteten Endkappen ausgerüstet werden.

*Illuminated end caps
Embouts éclairés*



RUNDE VARIANTE

Auch als Ringleuchten-Pendant verfügbar: sinus p.thirty.

*Round variant
Variante ronde*



VERSCHIEDENE DIFFUSOREN

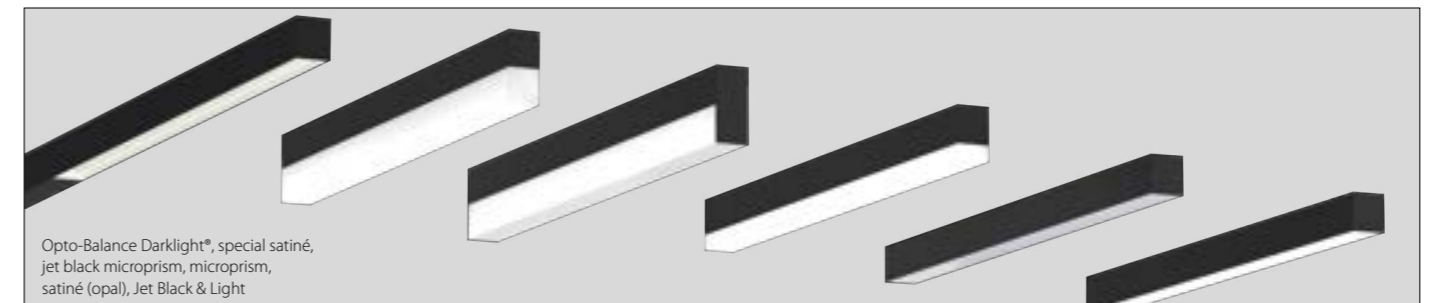

Opto-Balance Darklight®, special satiné, jet black microprism, microprism, satiné (opal), Jet Black & Light

SPEZIELLE ENDKAPPEN

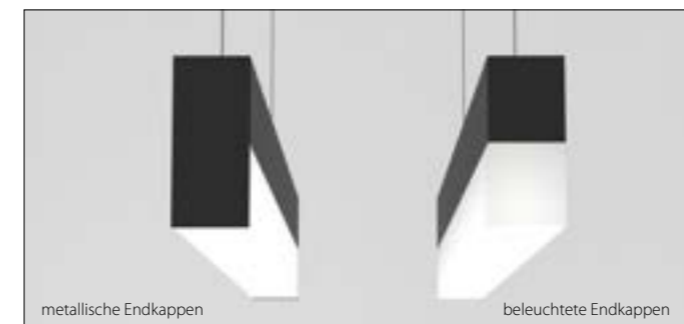

metallische Endkappen

beleuchtete Endkappen

OPTO-BALANCE DARKLIGHT® (INKL. OFFICE SPECIAL VARIANTE)

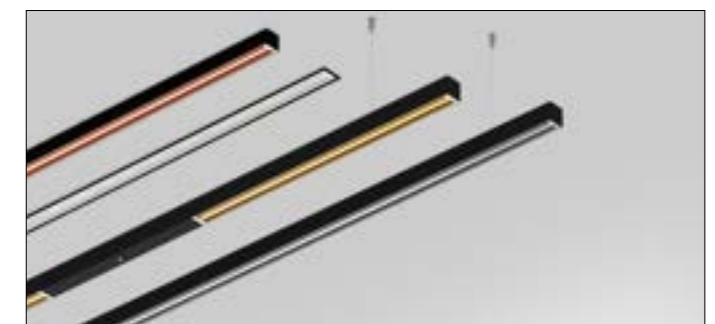

P.THIRTY - SMALL BUT POWERFUL

Inspiration

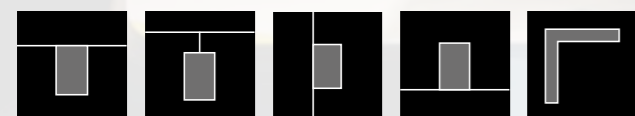

**P.THIRTY
PROJEKTE**



INSPIRATION

Produkt: p.thirty



INSPIRATION

Produkt: p.thirty



RATSSAAL WEINSBERG | DEUTSCHLAND

Produkte: p.thirty, pure 3
Foto: © Fotografie Dietmar Strauß, Besigheim | Architekten: MATTES RIGLEWSKI WAHL Architekten



INSPIRATION

Produkt: p.thirty





VERSCHIEDENE DIFFUSOREN

Opal-Diffusor, Mikroprisma, Extra-Comfort, Jet black & Light, satiné und asymmetrische Abdeckung.

Different covers | Différents diffuseurs



DIREKT / INDIREKTE BELEUCHTUNG

Optionale indirekte Beleuchtung im schlanken Produkt-Design.

*Direct / indirect lighting
Éclairage direct / indirect*



HOHER SEHKOMFORT

Ein asymmetrischer Linsenschutz sorgt für eine homogene Beleuchtung.

*Comfort plus
Confort visuel élevé*



SPOTLIGHT & DOWNLIGHT INSETS

anto+ und zenit S insets verfügbar

*Available insets
Spot et insets downlight*

DYNAMISCHES WEISS

Human Centric Lighting mit einstellbarem Weißton von 2700 bis 6500 Kelvin.

*Dynamic white
Blanc dynamique*



INTEGRIERTER SENSOR (OPTIONAL)

Integrierte Tageslicht- und Bewegungssensoren verfügbar.

*Sensor (optional)
Capteur intégré (en option)*



NOTLICHT

Erhältlich mit batteriebetriebener Notbeleuchtung im Falle eines Stromausfalls

*Emergency light
Éclairage de secours*



INDIVIDUELLE FARBEN

Gehäuse, Einsätze und Stromkabel sind in verschiedenen Farben erhältlich.

*Individual colours
Couleurs de corps*



INSETS

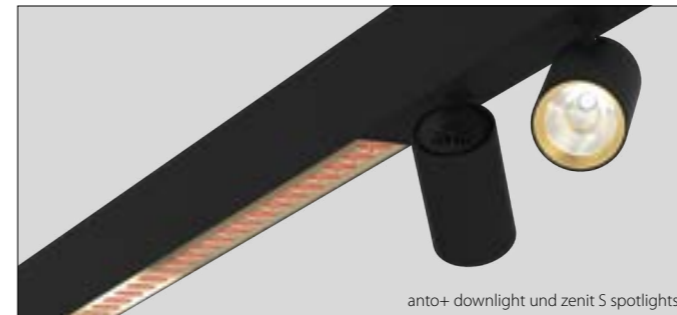

VERSCHIEDENE MONTAGEARTEN

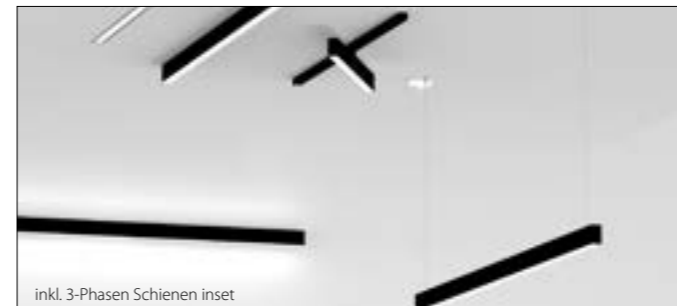

SHAPE & QUIET VERSIONEN



P.FORTY - LIGHTING TECHNOLOGY MEETS EYE COMFORT

Projekt: IGZ Campus Falkenberg | Deutschland
Foto: © David Franck, Ostfildern | Architekten: J. Mayer H. und Partner, Architekten MBB



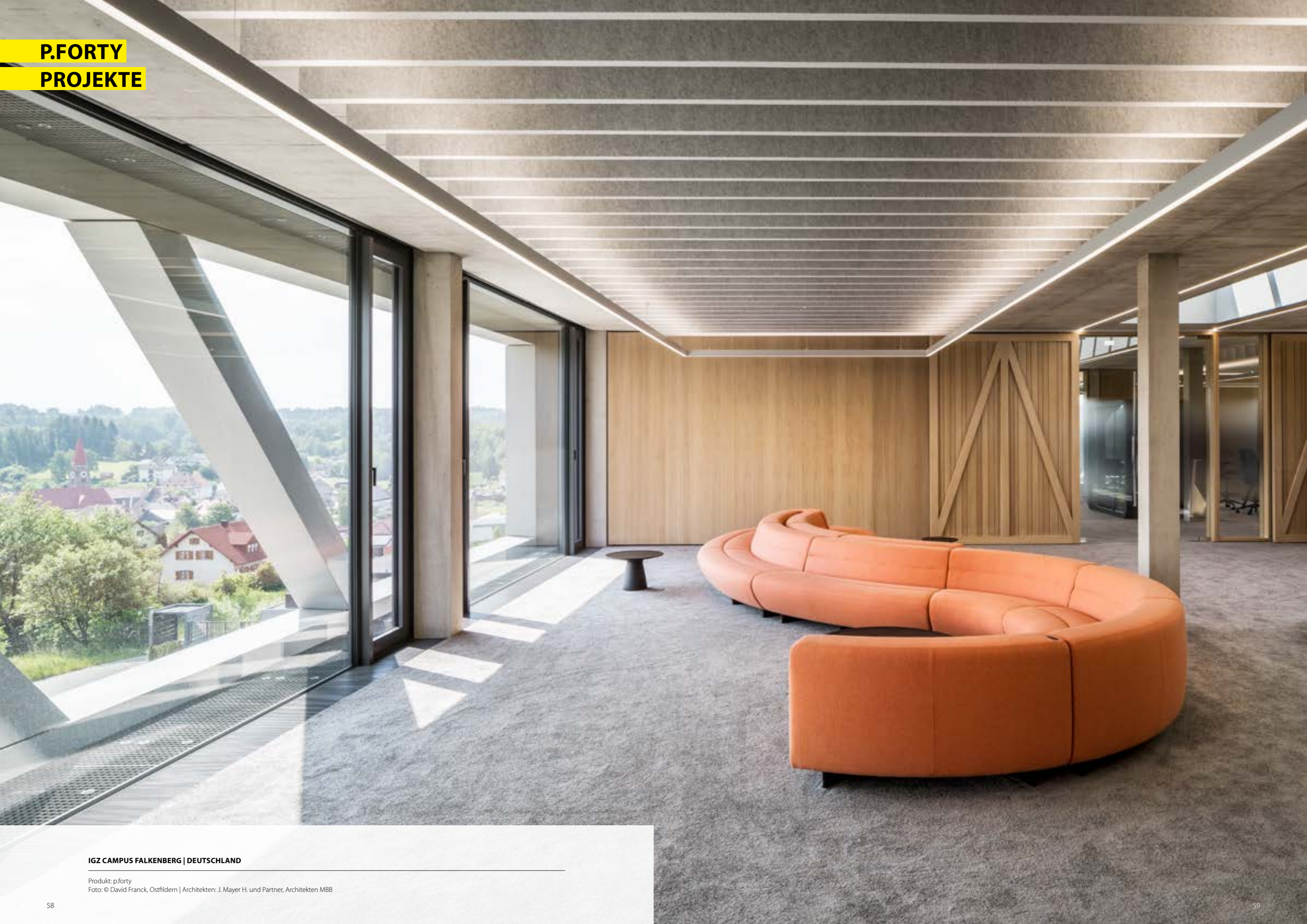

IGZ CAMPUS FALKENBERG | DEUTSCHLAND

Produkt: p.forty
Foto: © David Franck, Ostfildern | Architekten: J. Mayer H. und Partner, Architekten MBB



IGZ CAMPUS FALKENBERG | DEUTSCHLAND

Produkt: p.forty
Foto: © David Franck, Ostfildern | Architekten: J. Mayer H. und Partner, Architekten MBB





NUOVI UFFICI GIOBERT SPA RIVOLI | ITALIEN

Produkte: p.forty, anto+ insets



UNITED BANKERS | FINNLAND

Produkte: p.forty, anto+ insets





MODULARE FLEXIBILITÄT
Individuelle Beleuchtungslösungen durch die Kombination von Kurven und Linien.

*Modular flexibility
Flexibilité modulaire*



GELIEFERT ALS KOMPLETTLEUCHTE
PLANLICHT Beleuchtungslösungen sind vormontiert und leicht zu installieren.

*Complete luminaire
Livré comme luminaire complet*



VERSCHIEDENE REFLEKTOREN
Reflektoren

*Different reflectors
Différents réflecteurs*



DIREKT / INDIKRETE BELEUCHTUNG
Homogene und sanfte Ausleuchtung von Räumen mit optionaler indirekter Beleuchtung.

*Direct/indirect lighting
Éclairage direct / indirect*

DYNAMISCHES WEISS
Human Centric Lighting mit einstellbarem Weißlicht von 2.700 bis 6.500 Kelvin.

*Dynamic white
Blanc dynamique*



SCHMUTZ- & INSEKTENGESCHÜTZT
Wartungsarm dank staub- und insektenfestem Gehäuse.

*Dust- & insects proof
Protection contre la saleté et les insectes*



INTEGRIERTER SENSOR (OPTIONAL)
Integrierte Tageslicht- und Bewegungssensoren.

*Sensor (optional)
Capteur intégré (en option)*



BATTERIEBETRIEBENES NOTLICHT
Erhältlich mit batteriebetriebener Notbeleuchtung im Falle eines Stromausfalls.

*Emergency light
Éclairage de secours à batterie*



KOMBINATION VON LINIEN UND KURVEN

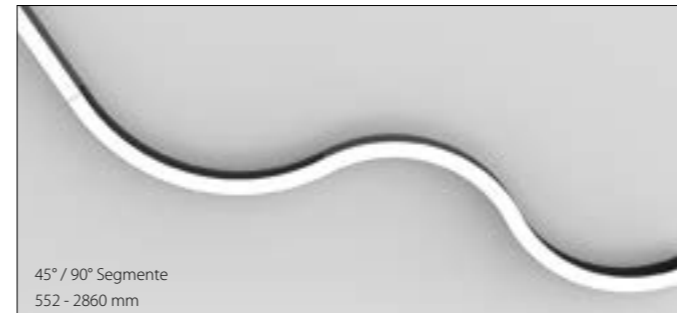

VERSCHIEDENE MONTAGEARTEN



PURE 3.GREEN

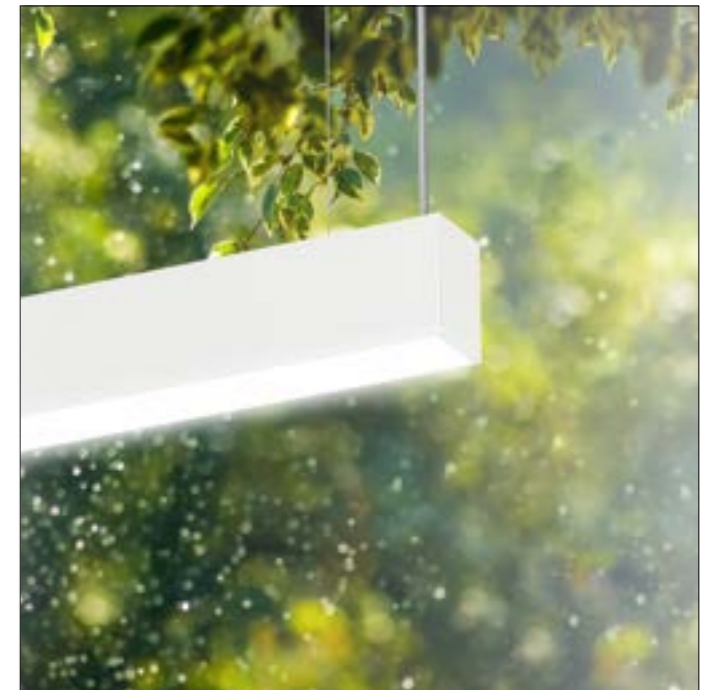

PURE 3 - SHAPELY FLEXIBILITY

Projekt: Neubau Gemeinschaftsschule Campus Cordis in Dresden | Deutschland
Foto: © Robert Gommlich Fotografie | Planer: RBZ Generalplanungsgesellschaft, Raum und Bau, AGZ Zimmermann Architekten GmbH

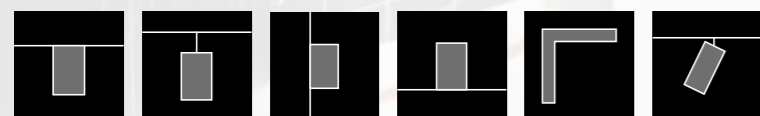

**PURE 3
PROJEKTE**

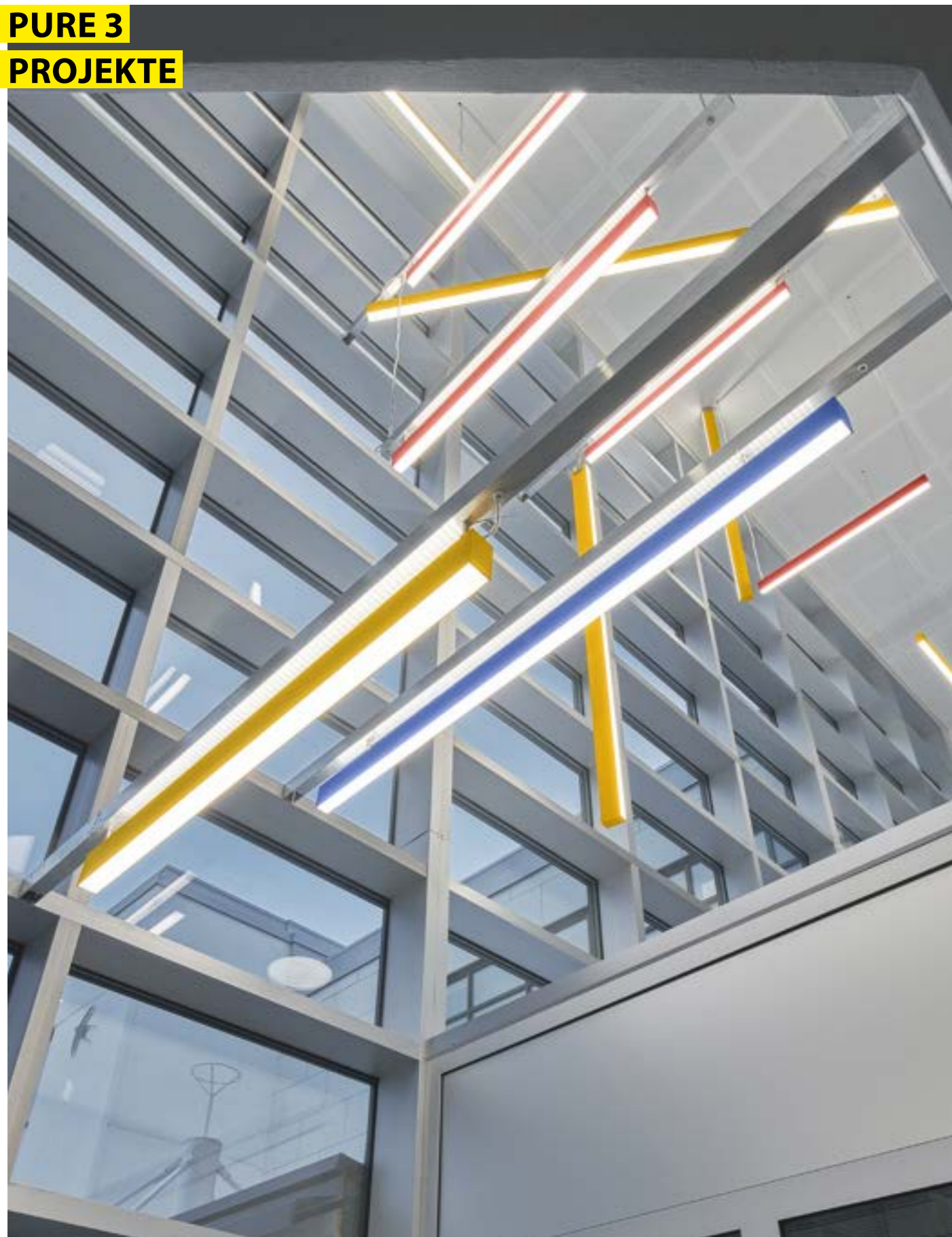

LAHDEN LUKIO GAUDIA | LAHTI, FINNLAND

Produkt: pure 3



NEUBAU GEMEINSCHAFTSSCHULE CAMPUS CORDIS IN DRESDEN | DEUTSCHLAND

Produkte: anto+ insets, p.forty
Foto: © Robert Gommlich Fotografie | Planer: RBZ Generalplanungsgesellschaft, Raum und Bau, AGZ Zimmermann Architekten GmbH



NEUBAU KINDERGARTEN IN POTSDAM HERMANNSWERDER | DEUTSCHLAND

Produkt: pure 3
Foto: © Robert Gommlich Fotografie | Architekten: Architekturbüro Raum und Bau GmbH



NEUBAU SCHULCAMPUS DRESDEN-TOLKEWITZ | DEUTSCHLAND

Produkt: pure 3
Foto: © Robert Gommlich Fotografie | Planung: AGZ Zimmermann Architekten GmbH, Raum und Bau

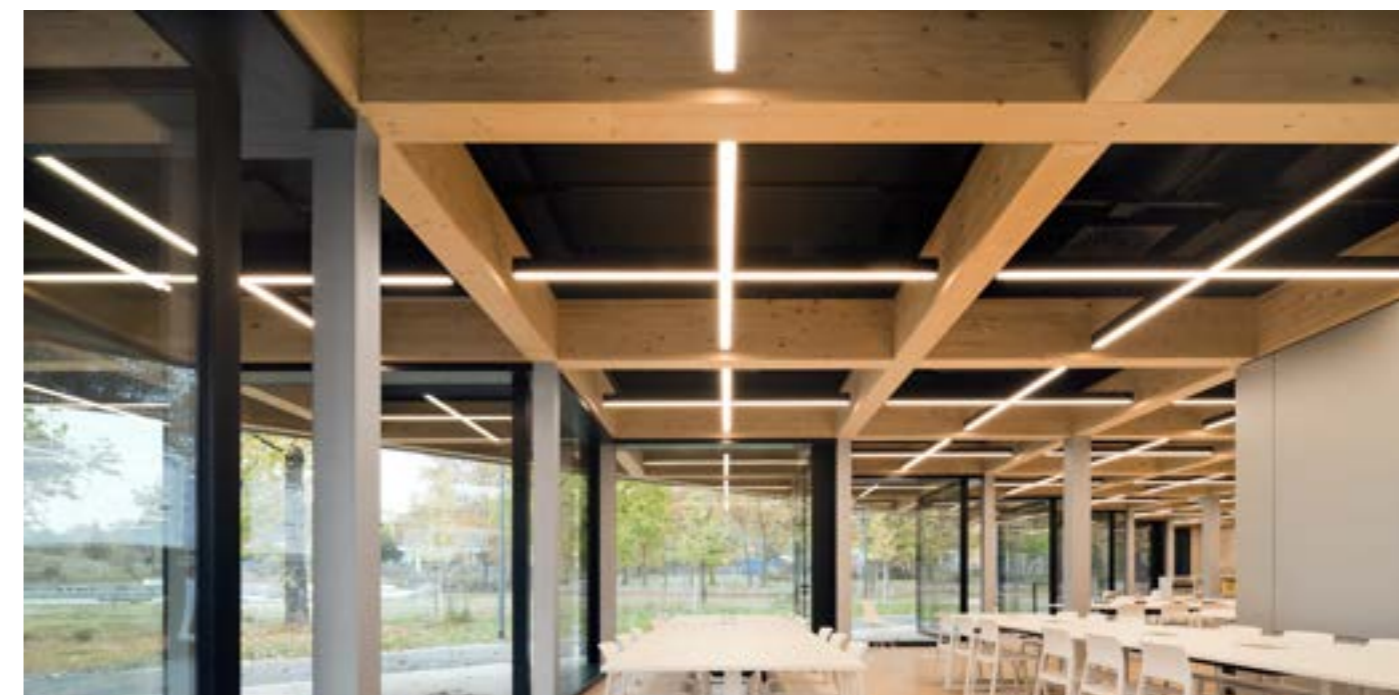

MENSA BERUFSSCHULZENTRUM NORD | DARMSTADT

Produkt: pure 3
Foto: © Brigida Gonzalez





SPEZIELLES RASTER-DESIGN

Die Louvre-Designs (BAP) sind in verschiedenen Effektfarben erhältlich. Neuer Raster: PLF

*Special louvre design
Design à lamelles spécial*



VERSCHIEDENE DIFFUSOREN

Die Leuchte ist auch mit opalem Diffusor oder Mikroprisma erhältlich.

*Different diffusers
Diffuseurs différents*



SPEZIALLEUCHE FÜR ARBEITSPLÄTZE

Beleuchtung von rechts und links, um Schatten und Reflexblendung zu vermeiden.

*Office special version
Luminaire spécial pour les postes de travail*



DIREKT / INDIKRETE BELEUCHTUNG

Homogene und sanfte Ausleuchtung von Räumen mit optionaler indirekter Beleuchtung.

*Direct/indirect lighting
Éclairage direct / indirect*

EINFACHE INSTALLATION

Die Einbauleuchte kann mühelos mit Montagehalterungen angebracht werden.

*Quick mounting
Installation facile*



DYNAMISCHES WEISS

Human Centric Lighting mit einstellbarem Weißlicht von 2.700 bis 6.500 Kelvin.

*Dynamic white
Blanc dynamique*



SPEZIELLE AKUSTIKVERSION

Die quadro.quiet bietet eine ausgezeichnete Schallabsorption.

*Special acoustic version
Version acoustique spéciale*



QUADRO.GREEN

Auch mit „green“-Gehäuse erhältlich (CO₂-reduziert)

*quadro.green
quadro.green*



QUADRO - DESIGN MEETS PERFORMANCE

Inspiration

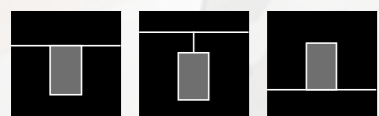

VERSCHIEDENE OPTIKEN



PLF Raster,
BAP Raster, Opal Diffusor, Mikroprisma

PLF - PARABOLIC LOUVRE FLAT (BREITSTRALENDE RASTER-VARIANTE)



Parabolische Längsreflektoren & Querlamellen
aus semi-matteloxiertem Reinst-Aluminium

TAUSENDE FARBKOMBINATIONEN

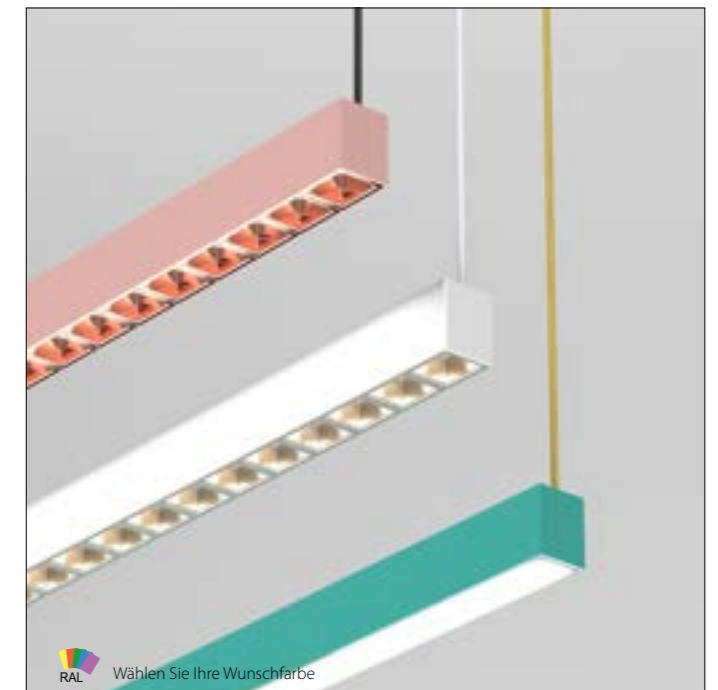

RAL Wählen Sie Ihre Wunschfarbe



FAMILIENGERICHT HEILBRONN | DEUTSCHLAND

Produkt: quadro
Foto: © Angelo Kaunat



ECOLE COMMERCE PARIS | FRANKREICH

Produkt: quadro
Foto: © Luc Boegly | Architekten: Pangalos Feldmann Architects & Lagranja Design



BWF GROUP SHOWROOM | DEUTSCHLAND

Produkt: quadro.quiet



INSPIRATION

Produkt: quadro

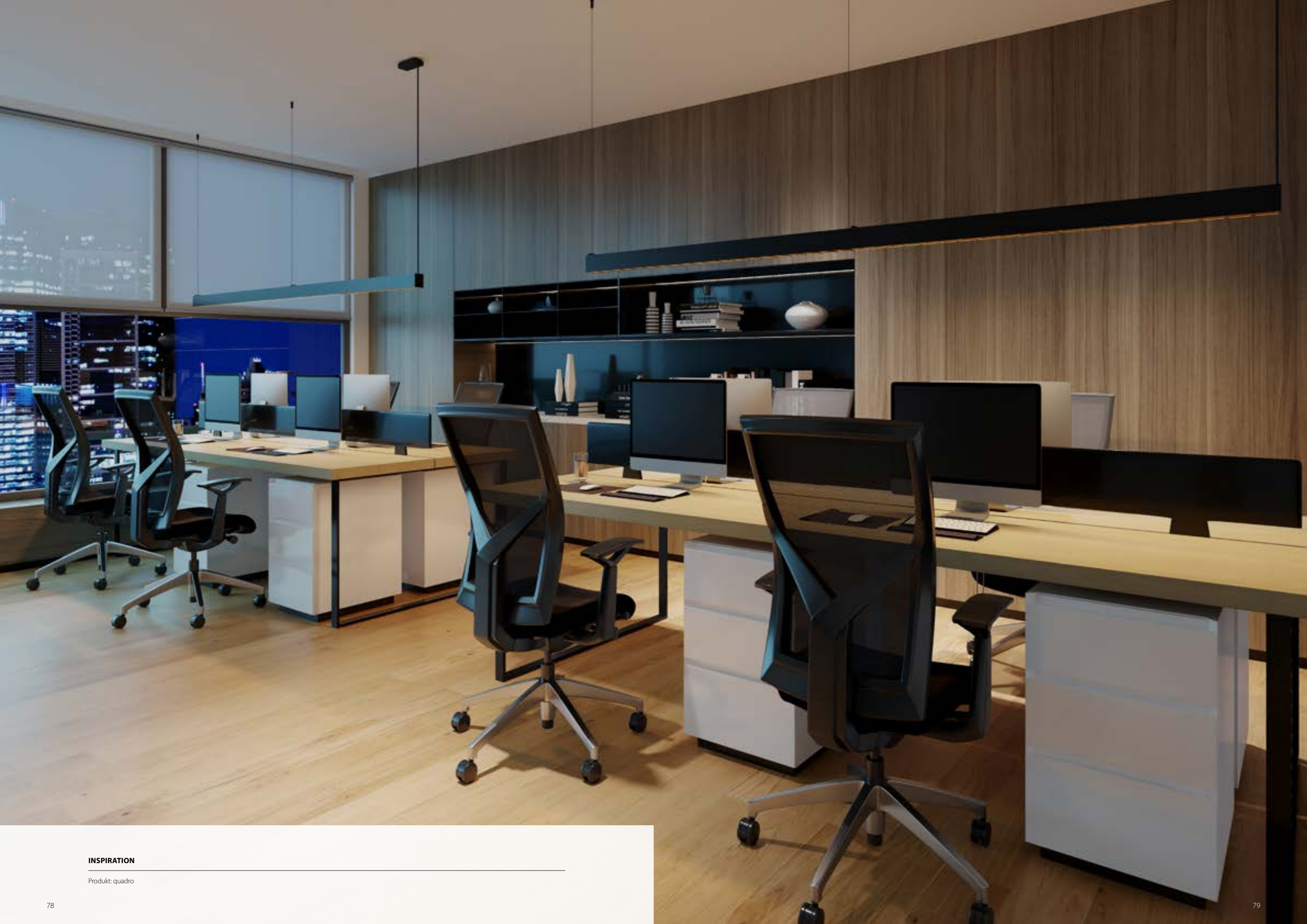

INSPIRATION

Produkt: quadro



KOMBINIERBARE LINIEN UND KURVEN
sinus lässt sich perfekt mit Linien des pure 3 Profilsystems kombinieren.

*Combining lines & curves
Lignes et courbes combinables*



SPEZIELLE AKUSTIKVERSION
Die sinus.quiet - Ausführung bietet hervorragende Schallabsorption.

*Special acoustic version
Version acoustique spéciale*



DIREKT / INDIREKTE BELEUCHTUNG
Homogene und sanfte Ausleuchtung von Räumen mit optionaler indirekter Beleuchtung.

*Direct/indirect lighting
Éclairage direct / indirect*



HOHER SEHKOMFORT
Wählen Sie zwischen homogenen Opal-Diffusoren und blendfreien Mikroprismen.

*Eye comfort
Confort visuel élevé*

DYNAMISCHES WEISS
Human Centric Lighting mit einstellbarem Weißlicht von 2.700 bis 6.500 Kelvin.

*Dynamic white
Blanc dynamique*



INTEGRIERTER SENSOR (OPTIONAL)
Integrierte Tageslicht- und Bewegungssensoren.

*Integrated sensor (optional)
Capteur intégré (en option)*



BATTERIEBETRIEBENES NOTLICHT
Erhältlich mit batteriebetriebener Notbeleuchtung bei Stromausfall.

*Emergency light
Éclairage de secours à batterie*



INDIVIDUELLE FARBEN
Gehäuse, Einsätze und Stromkabel sind in verschiedenen Farben erhältlich.

*Individual colours
Couleurs de corps*



KOMBINIERBARE LINIEN & KURVEN



sinus & pure 3

MONTAGEARTEN



SINUS.QUIET



SINUS - LIGHTING UNLEASHED

Projekt: Landratsamt Erlangen-Höchstadt | Deutschland
Foto: © tschinkersten fotografie





LAHDEN LUKIO GAUDIA | LAHTI, FINNLAND

Produkte: sinus, pure 3



NEUBAU SCHULCAMPUS DRESDEN-TOLKEWITZ | DEUTSCHLAND

Produkt: sinus
Foto: © Robert Gommlich Fotografie | Planung: AGZ Zimmermann Architekten GmbH, Raum und Bau



MENSA BERUFSSCHULZENTRUM NORD | DRESDEN

Produkt: sinus
Foto: © Brigida Gonzalez



BILDUNGSEINRICHTUNG DES BUNDES LEIPZIG | DEUTSCHLAND

Produkt: sinus.quiet
Foto: © pkfotografie





HERAUSRAGENDER DIFFUSOR

Ein ikonischer Diffusor zeichnet einen beleuchteten Ring auf der oberen und unteren Seite.

*Lateral diffuser
Diffusuer extraordinaire*



NAHTLOS VERARBEITETES GEHÄUSE

Unser Herstellungsprozess gewährleistet nahtlos verschweißte Gehäuse.

*Seamless frame/frameless
Corps sans soudure*



INDIVIDUELLE FARBEN

Gehäuse sind in verschiedenen Farben erhältlich.

*Individual colours
Couleurs de corps*



GERMAN DESIGN AWARD

Die ikonische Designleuchte ist mit dem German Design Award 2015 ausgezeichnet.

*German Design Award 2015
German Design Award 2015*

VERSCHIEDENE GRÖSSEN

Die Leuchte ist in verschiedenen Größen, die sich perfekt kombinieren lassen, erhältlich.

*Different sizes
Différentes tailles*



VERSCHIEDENE BALDACHINE

Wahlmöglichkeit zwischen zentraler und vertikaler Aufhängung.

*Different canopy types
Différents baldaquins*



DYNAMISCHES WEISS

Human Centric Lighting mit einstellbarem Weißlicht von 2.700 bis 6.500 Kelvin.

*Dynamic white
Blanc dynamique*



SCHUTZ VOR INSEKTEN

Wartungsarm dank eines insektenbeständigen Gehäuses.

*Insects proof
Protection insectes*



VERSCHIEDENE GRÖSSEN



HERAUSRAGENDER DIFFUSOR



DIE DESIGNERIN



HALO - CREATING ATMOSPHERE

Projekt: Nationalbank Tel Aviv | Isreal



**HALO
PROJEKTE**



LEUPHANA UNIVERSITÄT LÜNEBURG | DEUTSCHLAND

Produkte: halo, p.forty
Photo: © MarTiem Fotografie

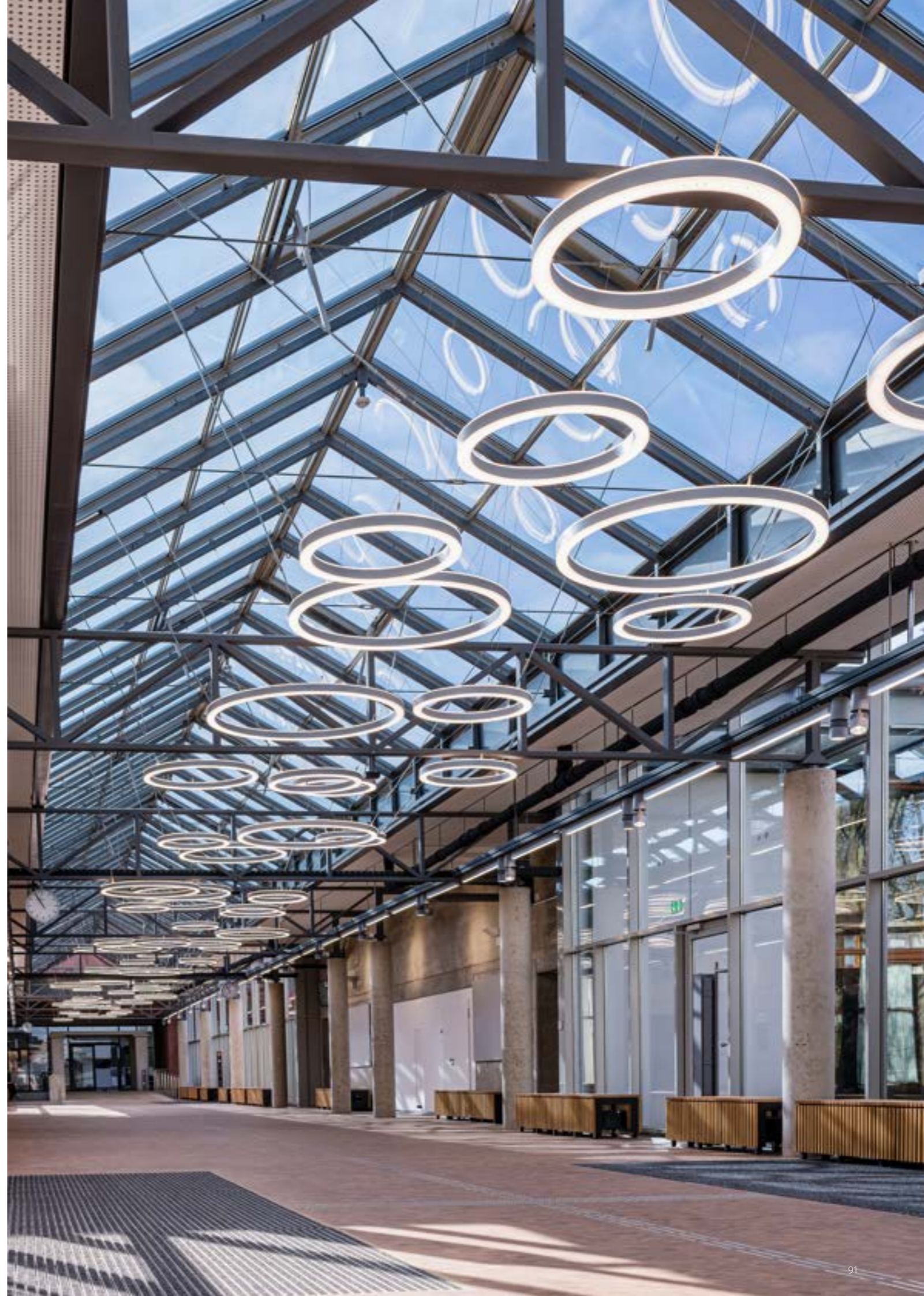



NEUBAU BERUFSSCHULZENTRUM WIRTSCHAFT IN DRESDEN | DEUTSCHLAND

Produkt: halo, p.forty
Foto: © Robert Gommlich Fotografie | Planung: AGZ Zimmermann Architekten GmbH



SIG COMBIBLOC SERVICES NEUHAUSEN AM RHEINFALL | SCHWEIZ

Produkt: halo
Foto: Andrin Winteler | Architekt: Dost Innenarchitektur



BETRIEBSGASTRO ULM | DEUTSCHLAND

Produkt: halo, ophelia



SQING - HALF SQUARE, HALF RING

Inspiration

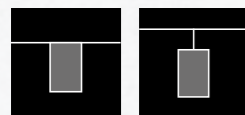

HERAUSRAGENDER DIFFUSOR

Ein ikonischer Diffusor zeichnet ein beleuchtetes Quadrat auf der oberen und unteren Seite.

*Lateral diffuser
Diffusuer extraordinaire*



NAHTLOS VERARBEITETES GEHÄUSE

Unser Herstellungsprozess gewährleistet nahtlos verschweißte Gehäuse.

*Seamless frame/frameless
Corps sans soudure*



INDIVIDUELLE FARBEN

Gehäuse sind in verschiedenen Farben erhältlich.

*Individual colours
Couleurs de corps*



BASIEREND AUF HALO

Basierend auf halo, unserer preisgekrönten Designleuchte von Nina Mair.

*Based on halo
Basé sur l'icône de design halo*

VERSCHIEDENE GRÖSSEN

Die Leuchte ist in verschiedenen Größen erhältlich, die sich perfekt kombinieren lassen.

*Different sizes
Différentes tailles*



VERSCHIEDENE BALDACHINE

Wahlmöglichkeit zwischen zentraler und vertikaler Aufhängung.

*Different canopy types
Différents baldaquins*



DYNAMISCHES WEISS

Human Centric Lighting mit einstellbarem Weißlicht von 2.700 bis 6.500 Kelvin.

*Dynamic white
Blanc dynamique*



SCHUTZ VOR INSEKTEN

Wartungsfrei dank eines insektenbeständigen Gehäuses.

*Insects proof
Protection insectes*



VERSCHIEDENE GRÖSSEN

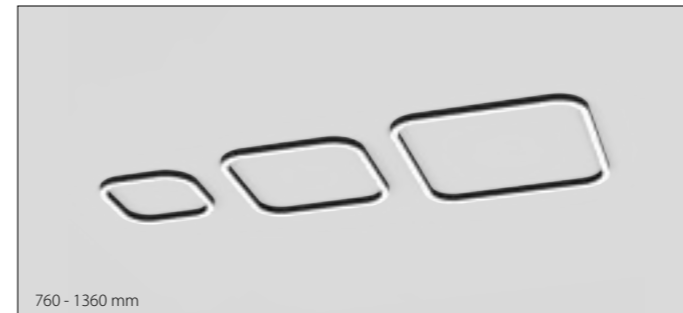

FARBKOMBINATIONEN



HERAUSRAGENDER DIFFUSOR



**SQING
PROJEKTE**



INSPIRATION

Produkt: sqing





INSPIRATION

Produkt: sqing

OPHELIA FEATURES



ENERGIEEFFIZIENZ

Die Leuchte bietet eine sehr hohe Lichtleistung bei geringem Stromverbrauch.

*Energy efficiency
Haute efficacité énergétique*



DIREKT / INDIREKTE BELEUCHTUNG

Die Leuchte ist auch mit aktivem indirektem Licht und passivem Aura-Effekt erhältlich.

*Direct / indirect lighting
Éclairage direct / indirect*



SPRITZWASSERGESCHÜTZT

Erhältlich in der IP54-Ausführung für Badezimmer.

*Splash water proof
Résistant aux éclaboussures d'eau.*



SCHMUTZ- UND INSEKTENSCHUTZ

Die Leuchte ist vor Staub und Insekten geschützt.

*Dust & insects proof
Protection contre la saleté et les insectes*

CLICK & PLAY INSTALLATION

Einfach das Gehäuse mit einem Klick auf den Baldachin drücken!

*Click & Play installation
Installation facile Click & Play*



DYNAMISCHES WEISS

Human Centric Lighting mit einstellbarem Weißlicht von 2.700 bis 6.500 Kelvin.

*Dynamic white
Blanc dynamique*



INTEGRIERTER SENSOR (OPTIONAL)

Integrierte Tageslicht- und Bewegungssensoren.

*Integrated sensor (optional)
Capteur intégré (en option)*



NOTLICHT

Erhältlich mit batteriebetriebener Notbeleuchtung im Falle eines Stromausfalls.

*Emergency light
Éclairage de secours à batterie*



OPHELIA - SIMPLICITY

Projekt: Ecole Commerce Paris | Frankreich
Foto: © Luc Boegly | Architekten: Pangalos Feldmann Architecture & Lagranja Design

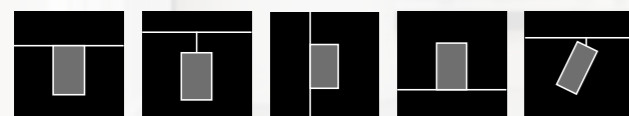

VERSCHIEDENE MONTAGEARTEN

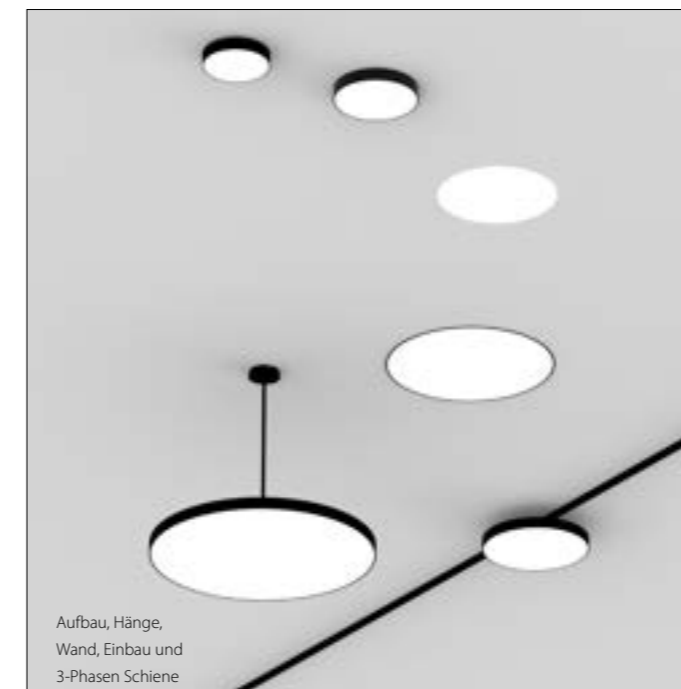

Aufbau, Hänge,
Wand, Einbau und
3-Phasen Schiene

UNTERSCHIEDLICHE ABHÄNGUNGEN

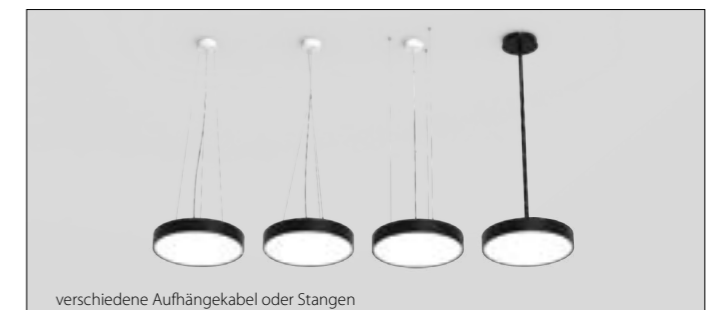

verschiedene Aufhängekabel oder Stangen

FARBKOMBINATIONEN



 Wählen Sie Ihre Wunschfarbe

**OPHELIA
PROJEKTE**



NEUBAU BERUFSSCHULZENTRUM WIRTSCHAFT IN DRESDEN | DEUTSCHLAND

Produkte: ophelia, p.forty
Foto: © Robert Gommlich Fotografie | Planung: AGZ Zimmermann Architekten GmbH



ECOLE COMMERCE PARIS | FRANKREICH

Produkt: ophelia
Foto: © Luc Boegly | Architekten: Pangalos Feldmann Architecture & Lagranja Design



NEUBAU KINDERGARTEN IN POTSDAM HERMANNswerDER | DEUTSCHLAND

Produkt: ophelia
Foto: © Robert Gommlich Fotografie | Architekten: Architekturbüro Raum und Bau GmbH



KINDERTAGESSTÄTTE CHLADENIUSSTRASSE | GROSSENHAIN, DEUTSCHLAND

Produkt: ophelia
Architekten: Ingenieurbüro Herzog & Partner GmbH
Neubau ausgezeichnet mit dem German Design Award 2024 in der Kategorie „Excellent Architecture“.



ODELIA FEATURES



ELEGANTES DESIGN

Ikonomisches uni- oder zweifarbiges Design mit speziellem Rahmen.

*Elegant design
Cadre design élégant*



ENERGIEEFFIZIENZ

Die Leuchte bietet eine sehr hohe Lichtleistung bei geringem Stromverbrauch.

*Energy efficiency
Haute efficacité énergétique*



DIREKT / INDIREKTE BELEUCHTUNG

Die Leuchte ist auch mit aktivem indirektem Licht und passivem Aura-Effekt erhältlich.

*Direct/indirect lighting
Éclairage direct / indirect*



HOHER SEHKOMFORT

Perfekter Augenkomfort mit optionalen Mikroprismen-Diffusoren.

*Eye comfort
Confort visuel élevé*

CLICK & PLAY INSTALLATION

Einfach das Gehäuse mit einem Klick auf den Baldachin drücken!

*Click & Play installation
Installation facile Click & Play*



SCHMUTZ- UND INSEKTENSCHUTZ

Die Leuchte ist vor Staub und Insekten geschützt.

*Dust & insects proof
Protection contre la saleté et les insectes*



DYNAMISCHES WEISS

Human Centric Lighting mit einstellbarem Weißlicht von 2.700 bis 6.500 Kelvin.

*Dynamic white
Blanc dynamique*



INTEGRIERTER SENSOR (OPTIONAL)

Integrierte Tageslicht- und Bewegungssensoren.

*Integrated sensor (optional)
Capteur intégré (en option)*



UNTERSCHIEDLICHE GRÖSSEN



VERSCHIEDENE ABHÄNGUNGEN



FARBKOMBINATIONEN



ODELIA - PURE ELEGANCE

Inspiration



**ODELIA
PROJEKTE**



INSPIRATION

Produkt: odelia



INSPIRATION

Produkt: odelia



INSPIRATION

Produkt: odella



INSPIRATION

Produkt: odella

LILIBET FEATURES



ENERGIEEFFIZIENZ

Die Leuchte bietet eine sehr hohe Lichtleistung bei geringem Stromverbrauch.

*Energy efficiency
Haute efficacité énergétique*



DIREKT / INDIREKTE BELEUCHTUNG

Die Leuchte ist auch mit aktivem indirektem Licht und passivem Aura-Effekt erhältlich.

*Direct / indirect lighting
Éclairage direct / indirect*



SPRITZWASSERGESCHÜTZT

Erhältlich in der IP54-Ausführung für Badezimmer.

*Splash water proof
Résistant aux éclaboussures d'eau.*



SCHMUTZ- UND INSEKTENSCHUTZ

Die Leuchte ist vor Staub und Insekten geschützt.

*Dust & insects proof
Protection contre la saleté et les insectes*

CLICK & PLAY INSTALLATION

Einfach das Gehäuse mit einem Klick auf den Baldachin drücken!

*Click & Play installation
Installation facile Click & Play*



DYNAMISCHES WEISS

Human Centric Lighting mit einstellbarem Weißlicht von 2.700 bis 6.500 Kelvin.

*Dynamic white
Blanc dynamique*



INTEGRIERTER SENSOR (OPTIONAL)

Integrierte Tageslicht- und Bewegungssensoren.

*Integrated sensor (optional)
Capteur intégré (en option)*



NOTLICHT

Erhältlich mit batteriebetriebener Notbeleuchtung im Falle eines Stromausfalls.

*Emergency light
Éclairage de secours à batterie*



UNTERSCHIEDLICHE GRÖSSEN

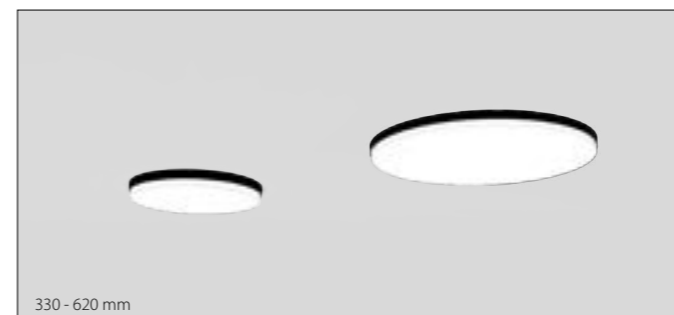

FARBKOMBINATIONEN

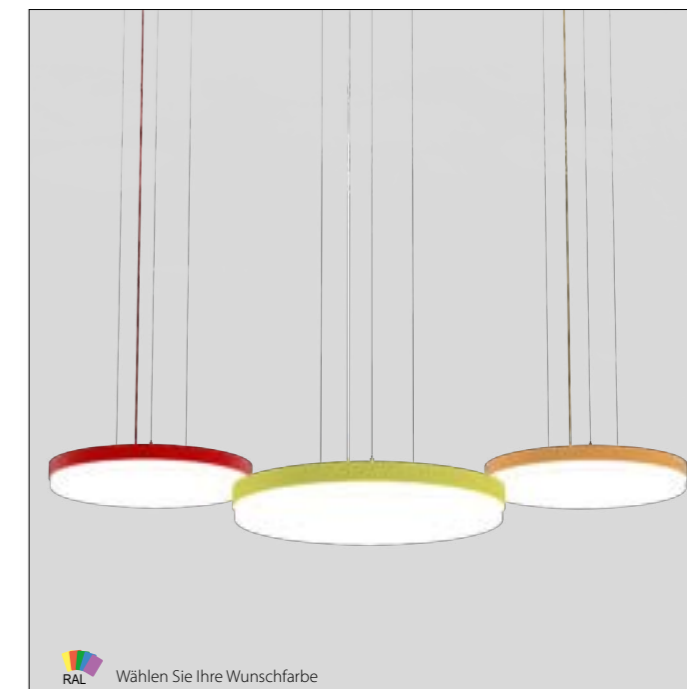

VERSCHIEDENE MONTAGEARTEN & ABHÄNGUNGEN



LILIBET - THAT CERTAIN SOMETHING

Inspiration





INSPIRATION

Produkt: lilibet

OLMO FEATURES



ENERGIEEFFIZIENZ

Die Leuchte bietet eine sehr hohe Lichtleistung bei geringem Stromverbrauch.

*Energy efficiency
Haute efficacité énergétique*



DIREKT / INDIREKTE BELEUCHTUNG

Die Leuchte ist auch mit aktivem indirektem Licht und passivem Aura-Effekt erhältlich.

*Direct / indirect lighting
Éclairage direct / indirect*



SCHMUTZ- UND INSEKTENSCHUTZ

Die Leuchte ist vor Staub und Insekten geschützt.

*Dust & insects proof
Protection contre la saleté et les insectes*



ADJUSTIERBAR NACH MONTAGE

Das Gehäuse kann nach der Montage gedreht und ausgerichtet werden.

*Adjustable
Ajustable après montage*

CLICK & PLAY INSTALLATION

Einfach das Gehäuse mit einem Klick auf den Baldachin drücken!

*Click & Play installation
Installation facile Click & Play*



DYNAMISCHES WEISS

Human Centric Lighting mit einstellbarem Weißlicht von 2.700 bis 6.500 Kelvin.

*Dynamic white
Blanc dynamique*



INTEGRIERTER SENSOR (OPTIONAL)

Integrierte Tageslicht- und Bewegungssensoren.

*Integrated sensor (optional)
Capteur intégré (en option)*



NOTLICHT

Erhältlich mit batteriebetriebener Notbeleuchtung im Falle eines Stromausfalls.

*Emergency light
Éclairage de secours à batterie*



UNTERSCHIEDLICHE GRÖSSEN

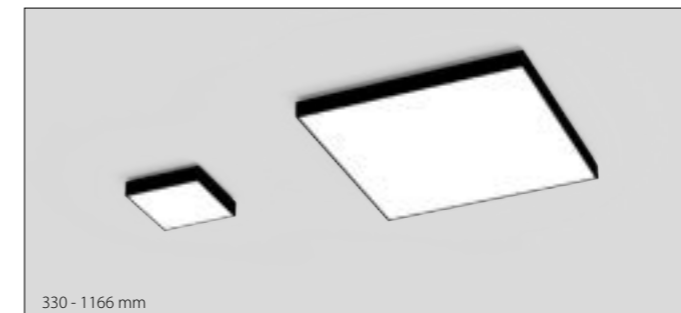

VERSCHIEDENE MONTAGEARTEN & ABHÄNGUNGEN



FARBKOMBINATIONEN



OLMO - SQUARE SHAPED EFFICIENCY

Inspiration



**OLMO
PROJEKTE**



INSPIRATION

Produkt: olmo

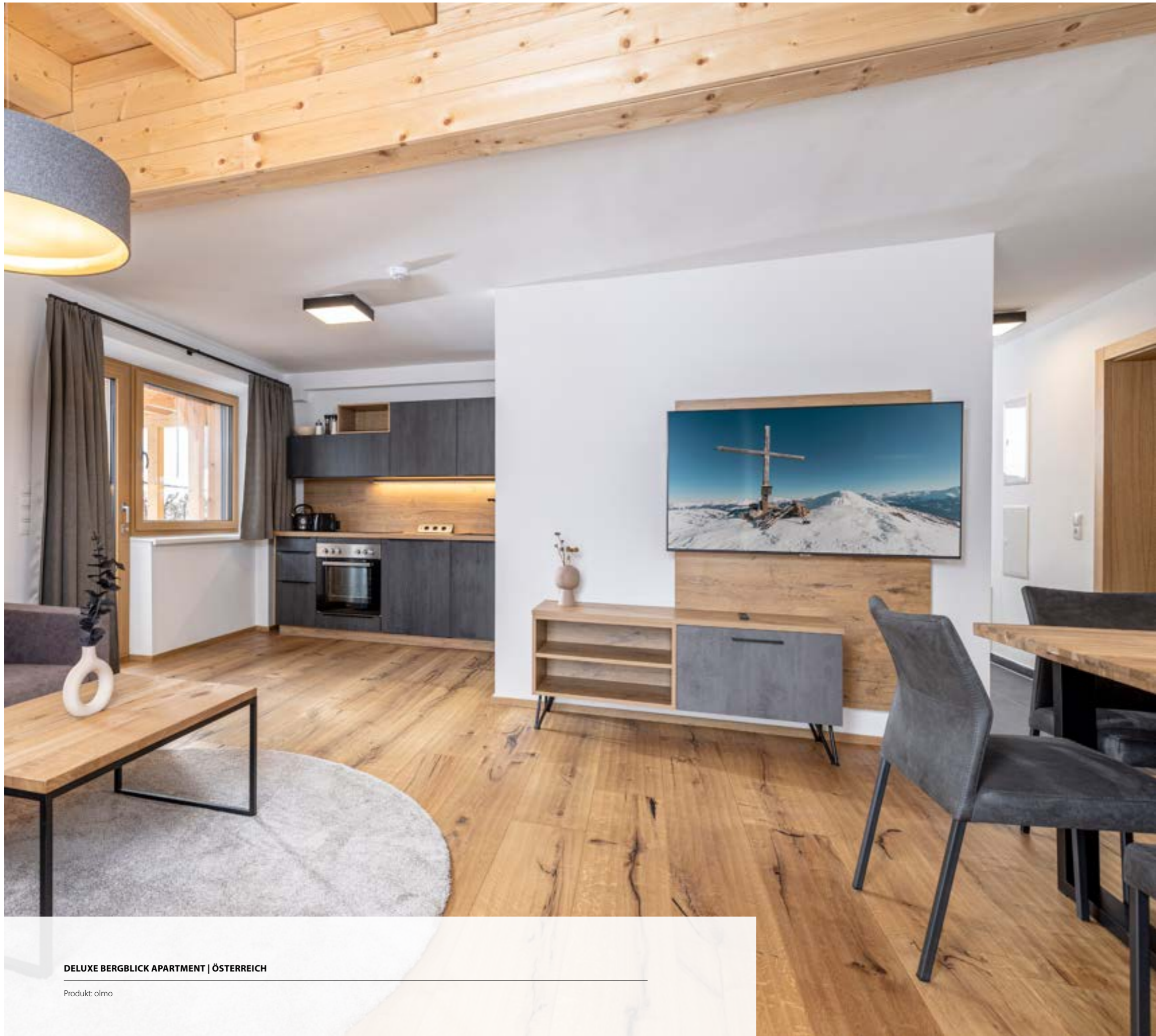

DELUXE BERGBLICK APARTMENT | ÖSTERREICH

Produkt: olmo



INSPIRATION

Produkte: olmo, anto+ insets





SKAI - POWERFUL EYE-CATCHER IN EVERY OFFICE

Inspiration

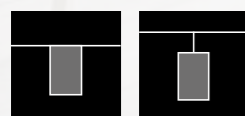

EINZIGARTIGE LINSEN-TECHNOLOGIE

Bis zu 160 Linsen bieten eine ideale Mischung aus gerichtetem und diffusen Licht.

*Unique lens technology
Technologie de lentilles exceptionnelle*



BLENDFREI (UGR <16)

Blendfreier Augenkomfort für jeden Arbeitsbereich.

*Glare-free (UGR <16)
Sans éblouissement (UGR < 16)*



INTEGRIERTES VORSCHALTGERÄT

Dank intelligentem Design ist der Baldachin minimalistisch.

*Integrated driver
Ballast intégré*



KABELINTEGRIERTE SEILABHÄNGUNG

Das Aufhängekabel kann in das Stromkabel integriert werden.

*Integrated feed-ins
Câble de suspension intégré au câble électrique*

DIREKT / INDIREKTE BELEUCHTUNG

Optionale indirekte Beleuchtung möglich

*Direct / indirect lighting
Éclairage direct / indirect*



DYNAMISCHES WEISS

Human Centric Lighting mit einstellbarem Weißlicht von 2.700 bis 6.500 Kelvin.

*Dynamic white
Blanc dynamique*



INDIVIDUELLE KABELFARBEN

Erhältlich mit transparentem Stromkabel oder 6 Textilkabeln in verschiedenen Farben.

*Individual cable colours
Couleurs de câble individuelles*



INDIVIDUELLE FARBEN

Das Gehäuse und Stromkabel sind in verschiedenen Farben erhältlich.

*Individual colours
Couleurs de corps individuelles*



FLACHES GEHÄUSE MIT EINER DICKE VON 18 MM

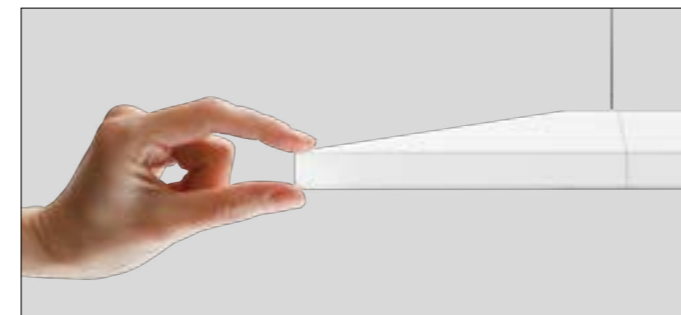

LINSENTECHNOLOGIE



FARBKOMBINATIONEN



RAL Wählen Sie Ihre Wunschfarbe

**SKAI
PROJEKTE**



INSPIRATION

Produkt: skai



AURA LIGHT ITALIA HEADQUARTER | ITALIEN

Produkt: skai
Foto: © Luca Cioci



INSPIRATION

Produkt: skai



TOURISMUSVERBAND BRIXEN | ITALIEN

Produkt: skai
Foto: © Samuel Holzner Fotografie



INSPIRATION

Produkt: skai



IKONISCHER LINSENTUBUS & MASKE
Verschiedene Farben in Metallic-Optik für einzigartige Meisterwerke.

Iconic lens tube & mask
Tube de lentille emblématique et masque



BLENDFREI (UGR <16)
Anspruchsvolle Linsentechnologie für blendfreien Augenkomfort.

Glare-free (UGR <16)
Sans éblouissement (UGR < 16)



VERSCHIEDENE LINSEN
Verschiedene Strahlwinkel und ovale Formen zur Beleuchtung von Böden und Wänden.

Different lenses
Différentes lentilles



NATÜRLICHE FARBWIEDERGABE
Der Farbwiedergabeindex (Ra > 90) dieser Leuchte garantiert natürliche Farben.

Natural color reproduction (CRI > 90)
Rendu naturel des couleurs (IRC > 90)

EINFACHE INSTALLATION
Einbauversionen können mit Montagehalterungen einfach installiert werden.

Easy mounting
Installation facile



INSETS FÜR PROFILSYSTEME
Das anto+ Downlight ist auch für pure 3- und p.forty-Profilssysteme erhältlich.

Insets for profile systems
Inserts pour systèmes de profilé



DYNAMISCHES WEISS
Human Centric Lighting mit einstellbarem Weißlicht von 2.700 bis 6.500 Kelvin.

Dynamic white
Blanc dynamique



INDIVIDUELLE FARBEN
Die Gehäuse, Einsätze und Stromkabel sind in verschiedenen Farben erhältlich.

Individual colours
Couleurs de corps individuelles



VERSCHIEDENE GRÖSSEN & PROFIL-EINSÄTZE

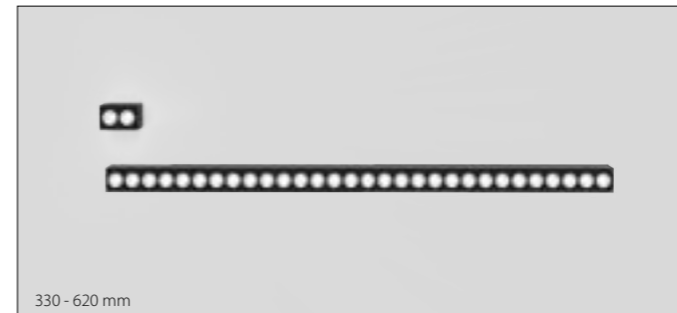

UNTERSCHIEDLICHE MONTAGEARTEN

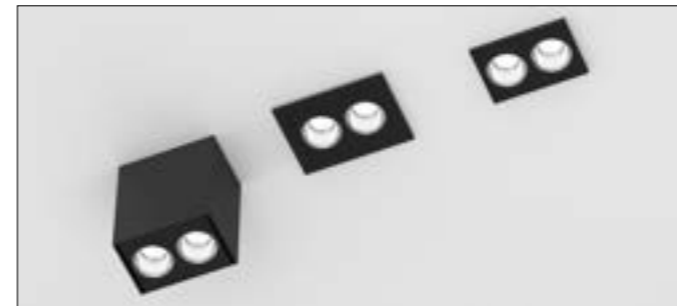

FARBKOMBINATIONEN

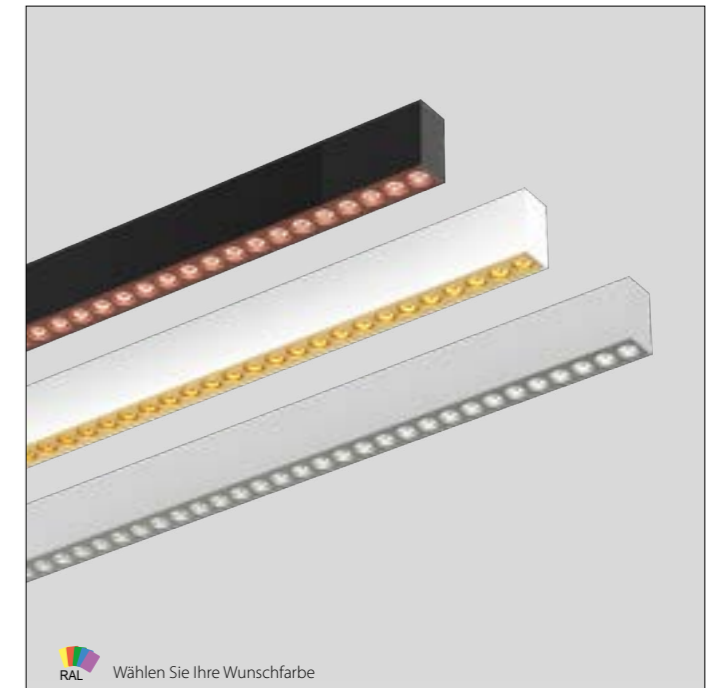

ANTO+ - LIKE JEWELLERY IN LIGHTING DESIGN

Projekt: Holiday Inn Messukeskus | Finnland
Foto: © Sampsa Paernaenen

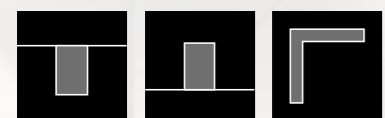





NUOVI UFFICI GIOBERT SPA RIVOLI | ITALIEN

Produkte: anto+, p.forty



NEUBAU GEMEINSCHAFTSSCHULE CAMPUS CORDIS IN DRESDEN | DEUTSCHLAND

Produkte: anto+ insets, p.forty
Foto: © Robert Gommlich Fotografie | Planer: RBZ Generalplanungsgesellschaft, Raum und Bau, AGZ Zimmermann Architekten GmbH



DELUXE BERGBLICK APARTMENT | ÖSTERREICH

Produkte: anto+, halo

ZENIT FEATURES



ENERGIEEFFIZIENZ

Die Leuchte liefert eine sehr hohe Lichtleistung bei geringem Stromverbrauch.

Energy efficiency
Haute puissance lumineuse



DREHBAR

Das Spotlight kann individuell eingestellt werden: Drehung bis zu 355°

Swivelling
Tournant



SCHWENKBAR

Optimale Beleuchtung: bis zu 90° schwenkbar

Tilt
Pivotant



SPEZIELLE LICHTFARBEN

Spezielle LED-Versionen erhältlich für Retail-Beleuchtungen.

Special light colours
Couleurs de la lumière spéciales

SPEZIELLE OPTIKEN

Wählen Sie aus verschiedenen Reflektoren, Linsen, einschließlich der Wabenlinse.

Special optics
Optiques spéciales



INSETS FÜR PROFILSYSTEME

zenit ist auch für pure 3, p.forty, p.thirty und 3-Phasen-Schienenysteme verfügbar.

Insets for profile systems
Inserts pour systèmes de profilé



INTEGRIERTES VORSCHALTGERÄT

Human Centric Lighting mit einstellbarem Weißlicht von 2.700 bis 6.500 Kelvin.

Driver integrated
Ballast intégré



INDIVIDUELLE FARBEN

Die Gehäuse, Einsätze und Stromkabel sind in verschiedenen Farben erhältlich.

Individual colours
Couleurs de corps individuelles



UNTERSCHIEDLICHE GRÖSSEN



VERSCHIEDENE MONTAGEARTEN FÜR ZENIT M



ZENIT XXS



ZENIT - DESIGNER'S SPOTLIGHT FAMILY

Inspiration



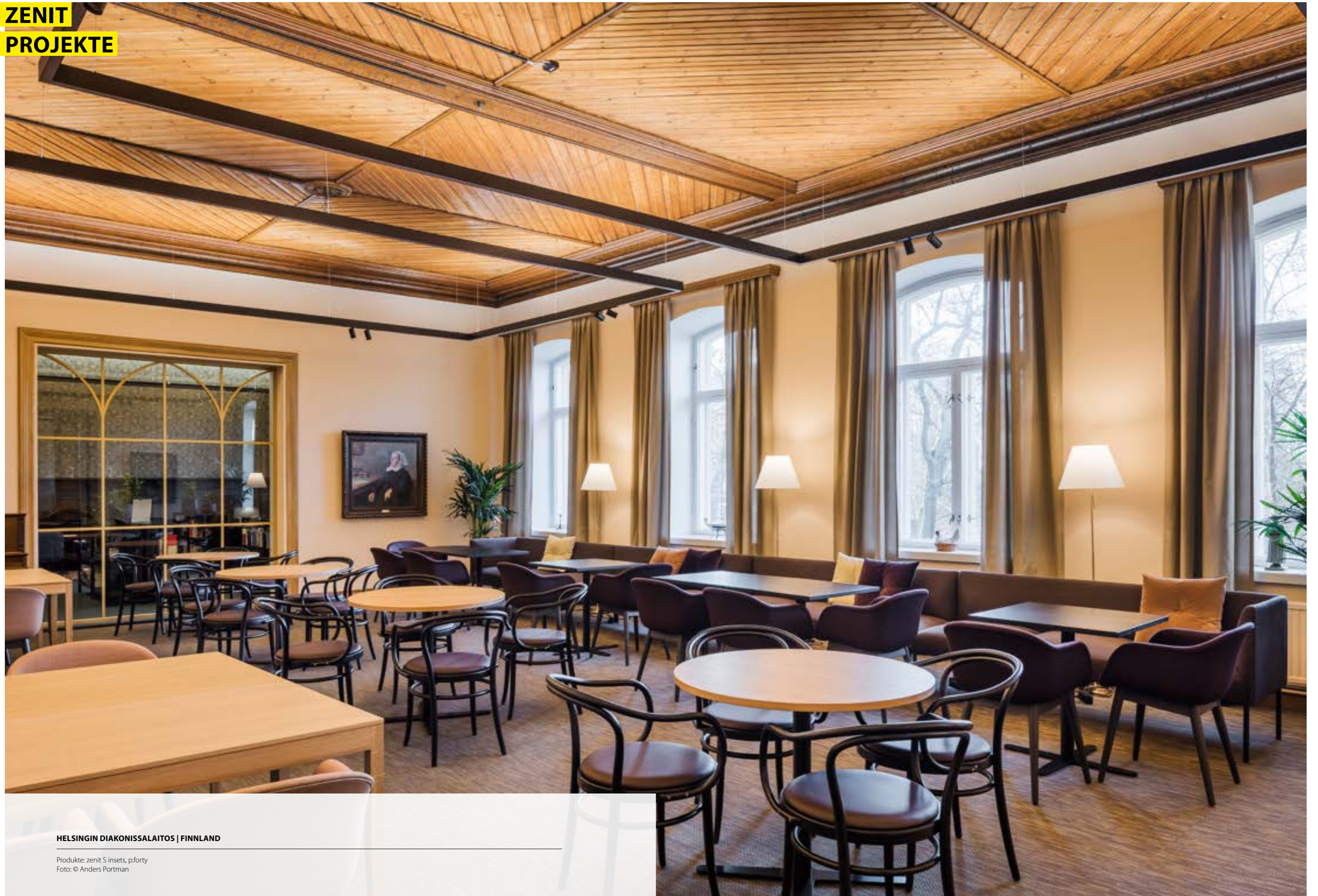

HELSINGIN DIAKONISSALAITOS | FINNLAND

Produkte: zenit S insets, p.forty
Foto: © Anders Portman



WÜRTH MODYF KÜNZELSAU | DEUTSCHLAND

Produkt: zenit M



DROPA | SCHWEIZ

Produkte: zenit 5 inset, pure 3
Foto: © LED-X



INSPIRATION

Produkt: zenit M



INSPIRATION

Produkt: zenit M



RUND & VIERECKIG

Das Spotlight ist in unterschiedlichen Formen erhältlich.

*Round & square
Différentes formes*



REFLEKTORTAUSCH

Der Sekundärreflektor kann ohne Werkzeug ausgetauscht werden.

*Reflector replacement
Remplacement du réflecteur*



HOCHGLANZBESCHICHTUNG

Metallische Hochglanzbeschichtungen verleihen eine besondere Optik.

*Effect coatings
Revêtements à effet*



LED

Das Spotlight nutzt die neueste LED-Technologie der Generation.

*LED technology of the latest generation
La technologie LED de dernière génération*

NATÜRLICHE FARBWIEDERGABE

Der Farbwiedergabeindex (Ra > 90) dieser Leuchte bietet natürliche Farben.

*Natural color reproduction (CRI > 90)
Rendu naturel des couleurs (IRC > 90)*



BLENDFREI (UGR < 16 / 19)

Die ausgeklügelte Linsentechnologie bietet blendfreien Augenkomfort.

*Glare-free (UGR < 16 / 19)
Sans éblouissement (UGR < 16 / 19)*



355° DREHBARKEIT

Das Spotlight kann individuell um bis zu 355° gedreht werden.

*355° swiveling
Tournant 355°*



30° SCHWENKBAR

Für den richtigen Fokus kann der Neigungswinkel bis zu 30° verstellt werden.

*30° tilt
Pivotant 30°*



UNTERSCHIEDLICHE GRÖSSEN



diva S und diva M

VERSCHIEDENE FORMEN

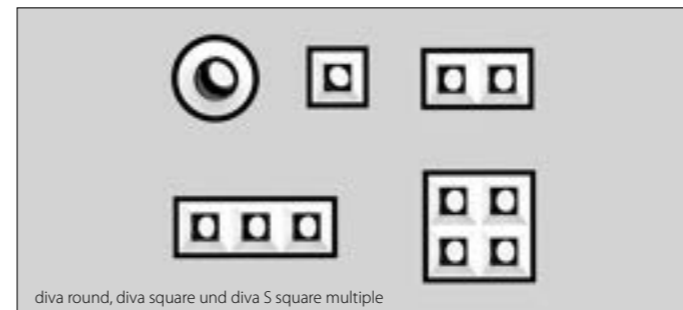

diva round, diva square und diva S square multiple

FARBKOMBINATIONEN

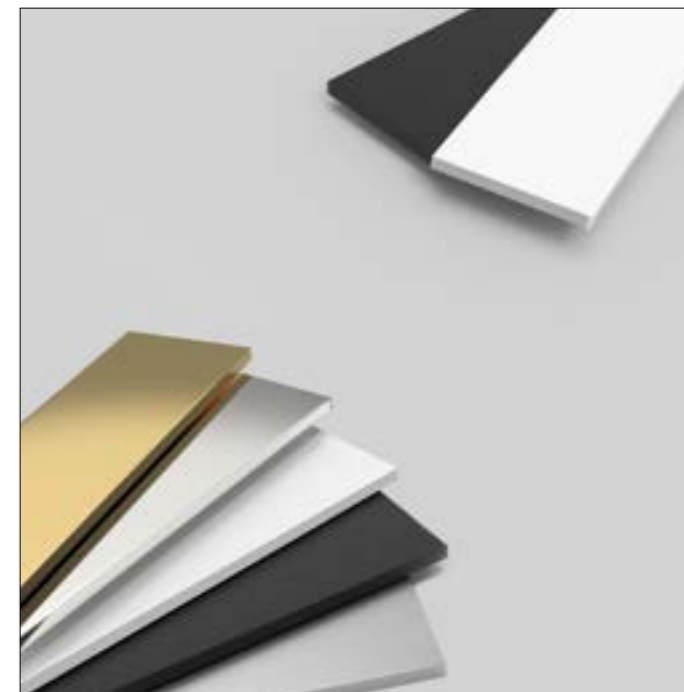

DIVA - SPOTLIGHTS ON!

Inspiration

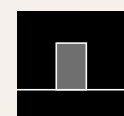



INSPIRATION

Produkt: diva

MONTAGEARTEN-MATRIX

	anto+	diva	halo	lilibet	odelia	olmo	ophelia
						liha	

p.forty	p.thirty	pure 3	quadro	sinus	skai	sqing	zenit



Aufbauleuchten

Surface-mounted luminaires
Luminaires en saillie

162

Hängeleuchten

Pendant luminaires
Suspension

208

Wandleuchten

Wall luminaires
Applique murale

264

Einbauleuchten

Recessed luminaires
Luminaires encastré

286

Systeme

Systems
Systèmes

352

Stehleuchte

Floor lamp
Lampadaire

392

3-Phasen-Leuchten

3-phase track lights
Luminaires pour rail 3 phases

396

Features & Zubehör

Features & additional equipment
Équipements supplémentaires

428

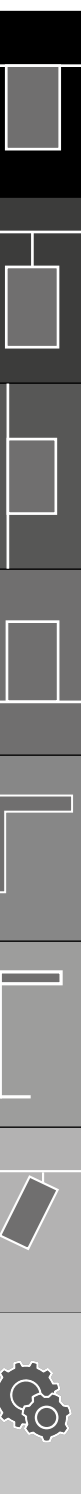

AUFBAU - LEUCHTEN

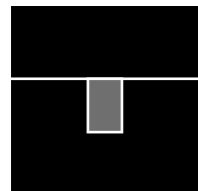

Surface-mounted luminaires
Luminaires en saillie

PROFILLEUCHTEN | PROFILE LUMINAIRES | LUMINAIRES PROFILÉS

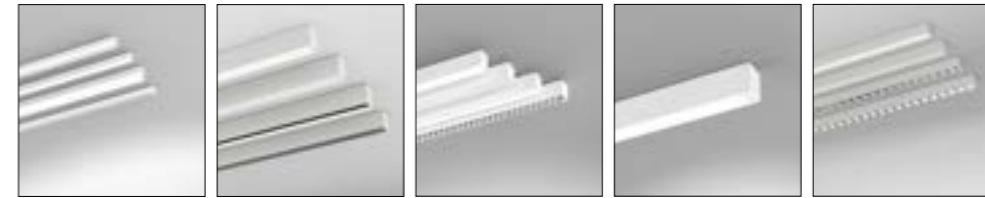

P.THIRTY
164

P.FORTY
168

PURE 3
172

PURE 2 IP54
178

QUADRO
180

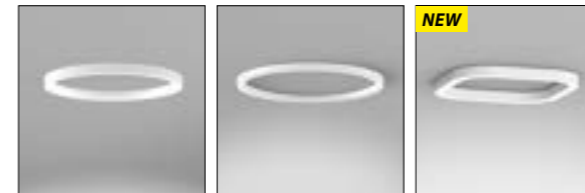

SINUS
182

HALO
184

NEW
SQING
186

FLÄCHENLEUCHTEN | AREA LUMINAIRES | LAMPES DE SURFACE

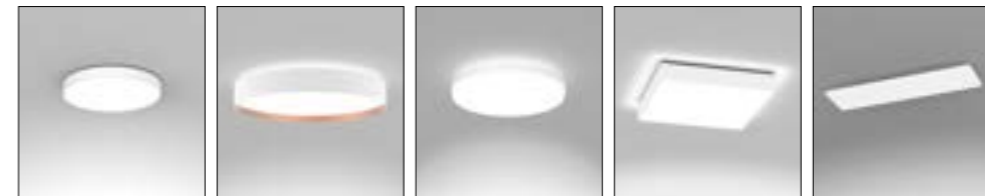

OPHELIA
188

ODELIA
190

LILIBET
192

OLMO
194

SKAI
196

DOWNLIGHTS & STRAHLER | DOWNLIGHTS & SPOTLIGHTS | DOWNLIGHTS & PROJECTEURS

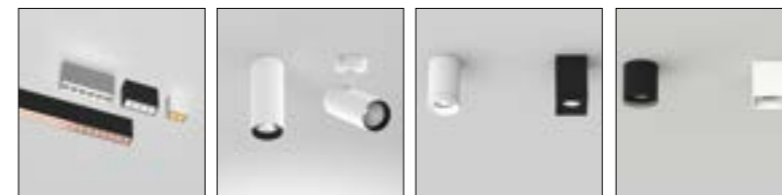

ANTO+
198

ZENIT
200

SPACETUBE
204

SPOTLIGHT 80
206

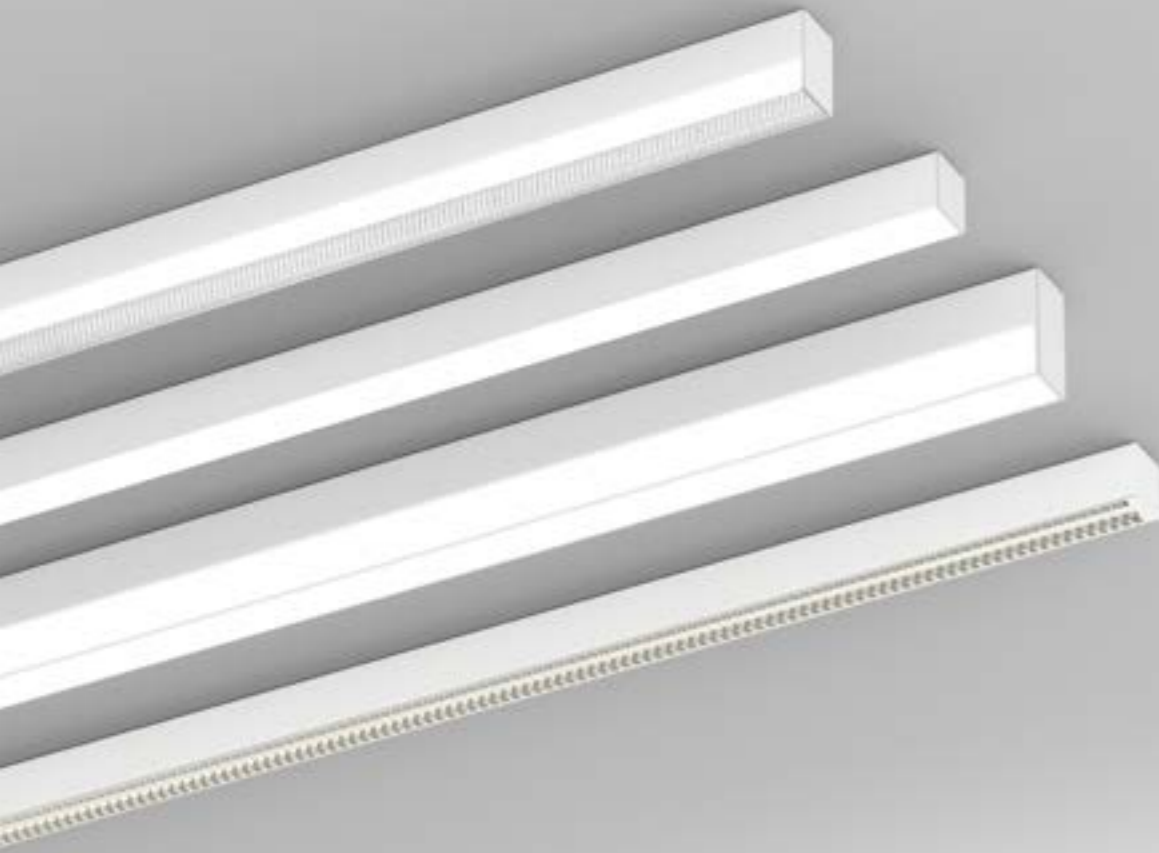

1 SIZE

557 mm (non-dim)	055
827 mm	082
1187 mm	118
1457 mm	145
2899 mm	289
3531 mm	353
4341 mm	434

2 COLOUR

	silver	9006
	white	9016
	black	9005
	RAL of your choice	

3 LED

	2700 K, CRI > 90	927
	3000 K, CRI > 90	930
	4000 K, CRI > 90	940
	4000 K, CRI > 80	840

4 OUTPUT / CONTROL

DIFFUSER		
	low output non-dim	L1
	low output DALI	L3
	high output non dim (557 mm)	H1
	high output DALI	H3
OBD (Opto-Balance Darklight®)		
	high output non dim	H1
	high output DALI	H3
	very high output non-dim (not 827mm)	V1
	very high output DALI (not 827mm)	V3

5 OPTIC

	satiné	S
	jet black & light	J NEW
	microprism*	M
	U-shaped satiné, 15 mm	U
	U-shaped satiné, 34 mm	Q
	U-shaped jet black microprism, 15 mm*	V
	Opto-Balance Darklight® BAP high-gloss black chrome*	Z NEW
	Opto-Balance Darklight® BAP high-gloss copper*	K NEW
	Opto-Balance Darklight® BAP high-gloss gold*	G NEW
	Opto-Balance Darklight® BAP high-gloss silver*	B NEW

* UGR-optimised, configure online

P30A 1-2 C1 3 4 5

P30A082-9016C1930H35 Surface, 827 mm, white, IP20, direct, 3000 K, CRI > 90, high output DALI, satiné (order sample)

► Configure online on KATALOG.PLANLICHT.COM

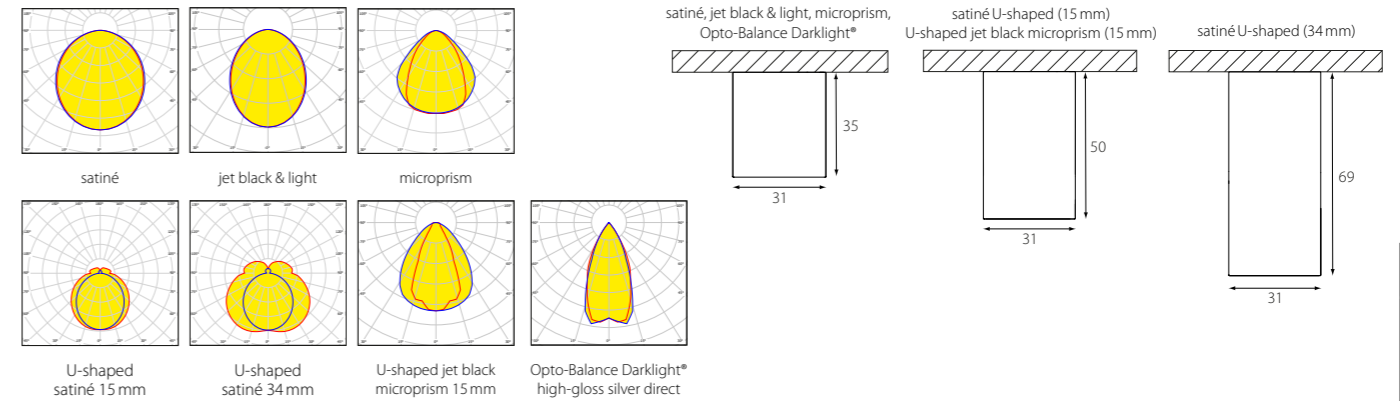

LUMINOUS FLUX (LM) / SYSTEM POWER (W), 4000 K, CRI > 80

4000 K satiné CRI > 80	low output	high output	very high output	
557 mm	930 lm / 8 W	1324 lm / 11,5 W		0,6 kg
827 mm	1388 lm / 10,5 W	1981 lm / 15,5 W		0,8 kg
1187 mm	1999 lm / 14,5 W	2855 lm / 21 W		1,1 kg
1457 mm	2457 lm / 17 W	3512 lm / 25 W		1,3 kg
2899 mm	4895 lm / 34 W	7008 lm / 50 W		2,5 kg
3531 mm	5961 lm / 43 W	8537 lm / 62 W		3,0 kg
4341 mm	7331 lm / 51 W	10503 lm / 74 W		3,7 kg

(based on optic Q)

COMPARE COVER 1457 MM, 4000 K, CRI > 80

	low output	high output	very high output
satiné	2457 lm	3512 lm	
jet black & light	506 lm	723 lm	
microprism*	2534 lm	3624 lm	
U-shaped satiné (15 mm)	2588 lm	3710 lm	
U-shaped satiné (34 mm)	2724 lm	3903 lm	
U-shaped jet black microprism (15 mm)	1419 lm	2020 lm	
Opto-Balance Darklight® high-gloss silver		1941 lm	3836 lm

COMPARE LIGHT COLOUR 1457 MM, SATINÉ

4000 K, CRI > 80	3512 lm
2700 K, CRI > 90	2637 lm
3000 K, CRI > 90	2769 lm
4000 K, CRI > 90	2862 lm

*Der angegebene Lichtstrom bezieht sich auf die Leuchte mit klarer mikroprismatischer Abdeckung. Die Leuchte wird mit satinierter Folie zur Erhöhung der Homogenität geliefert (Direkt strahlend: -13,9%, direkt/indirekt strahlend: -6,9% Lichtstrom). Die angegebenen Lichtstromwerte (lm) beziehen sich auf Leuchten mit einem weißen Gehäuse (RAL 9016). Je nach Gehäusefarbe und Länge reduzieren sich diese entsprechend (bezieht sich nur auf U-förmige Abdeckungen).

The indicated luminous flux corresponds to the luminaire with a clear microprismatic diffuser. The luminaire is delivered with a satinized-foil for increased homogeneity (direct: -13,9%, direct-indirect: -6,9% luminous flux).

All figures of luminous flux (lm) are for fixtures with white housing (RAL 9016). Depending on the housing colour and length, the luminous flux is reduced accordingly. This only applies to U-shaped optics.

Le flux lumineux indiqué correspond au luminaire avec diffuseur microprismatique transparent. Le luminaire est livré avec un film satiné pour optimiser l'homogénéité (direct: -13,9%, direct-indirect: -6,9% sur le flux lumineux).

Les valeurs de flux lumineux (lm) indiquées se réfèrent aux luminaires à corps blanc (RAL 9016). En fonction de la couleur du corps et de la longueur, celles-ci sont réduites en conséquence (se réfère uniquement aux caches en forme de U).



Down to UGR ≤ 16 | up to 167 lm / W | up to 2958 lm / m | IEC 62471: Blue light hazard: RG 0 | DALI push switchDIM

P.THIRTY PROFILE SYSTEM 354



p.thirty IP44

Aufbauleuchte
Surface luminaire
Luminaires en saillie

P.THIRTY | SURFACE

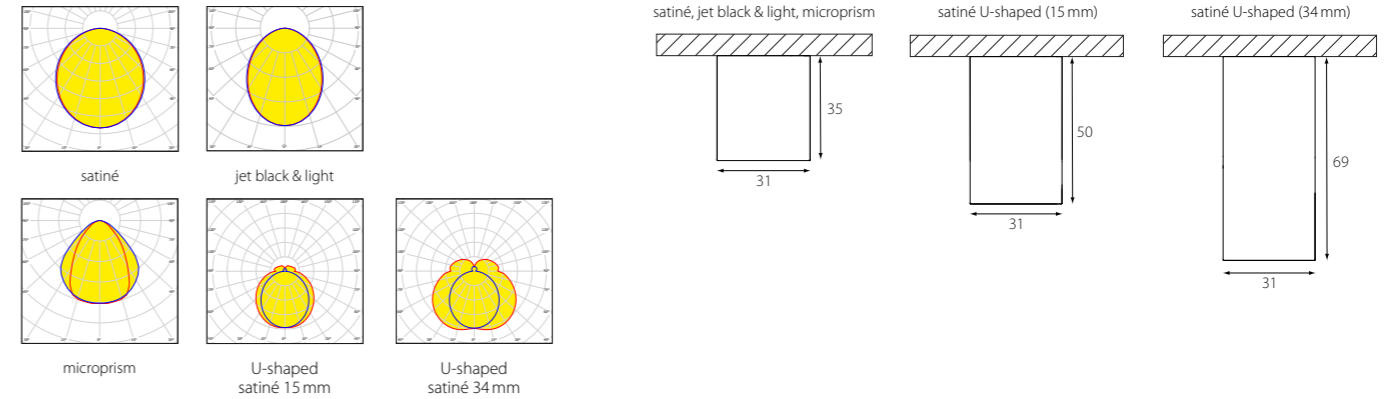
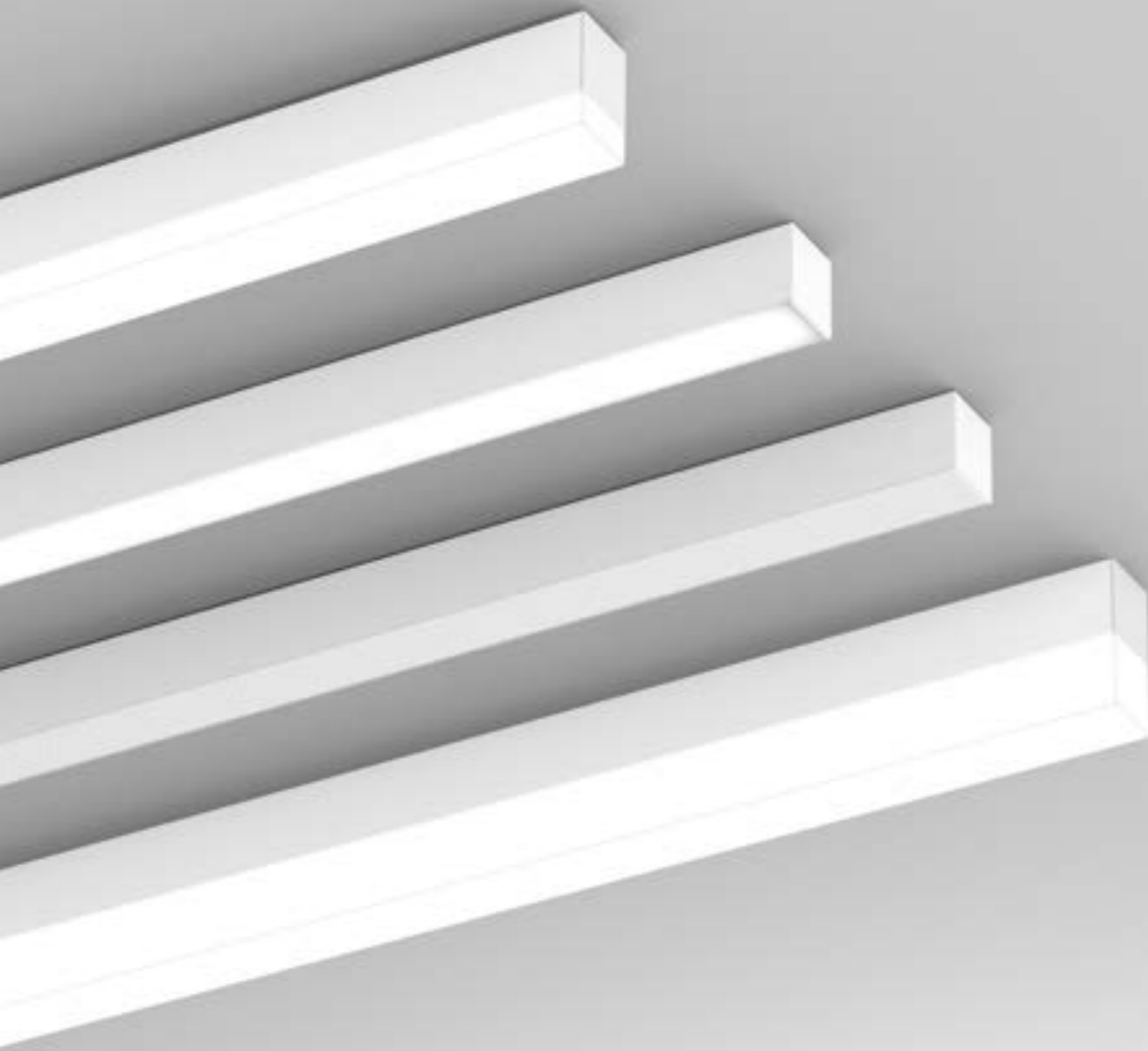

LUMINOUS FLUX (LM) / SYSTEM POWER (W), 4000 K, CRI > 80

4000 K satiné CRI > 80	low output	high output	
557 mm	930 lm / 8 W	1324 lm / 11,5 W	0,6 kg
827 mm	1388 lm / 10,5 W	1981 lm / 15,5 W	0,8 kg
1187 mm	1999 lm / 14,5 W	2855 lm / 21 W	1,1 kg
1457 mm	2457 lm / 17 W	3512 lm / 25 W	1,3 kg

(based on optic Q)

COMPARE COVER 1457 MM, 4000 K, CRI > 80

	low output	high output
satiné	2457 lm	3512 lm
jet black & light	506 lm	723 lm
microprism*	2534 lm	3624 lm
U-shaped satiné (15 mm)	2588 lm	3710 lm
U-shaped satiné (34 mm)	2724 lm	3903 lm

COMPARE LIGHT COLOUR 1457 MM, SATINÉ

4000 K, CRI > 80	3512 lm
2700 K, CRI > 90	2637 lm
3000 K, CRI > 90	2769 lm
4000 K, CRI > 90	2862 lm

*Der angegebene Lichtstrom bezieht sich auf die Leuchte mit klarer mikroprismatischer Abdeckung. Die Leuchte wird mit satinierter Folie zur Erhöhung der Homogenität geliefert (Direkt strahlend: -13,9% , direkt/indirekt strahlend: -6,9% Lichtstrom). Die angegebenen Lichtstromwerte (lm) beziehen sich auf Leuchten mit einem weißen Gehäuse (RAL 9016). Je nach Gehäusefarbe und Länge reduzieren sich diese entsprechend (bezieht sich nur auf U-förmige Abdeckungen). The indicated luminous flux corresponds to the luminaire with a clear microprismatic diffuser. The luminaire is delivered with a satinized foil for increased homogeneity (direct: -13,9%, direct-indirect: -6,9% luminous flux). All figures of luminous flux (lm) are for fixtures with white housing (RAL 9016). Depending on the housing colour and length, the luminous flux is reduced accordingly. This only applies to U-shaped optics. Le flux lumineux indiqué correspond au luminaire avec diffuseur microprismatique transparent. Le luminaire est livré avec un film satiné pour optimiser l'homogénéité (direct: -13,9%, direct-indirect: -6,9% sur le flux lumineux). Les valeurs de flux lumineux (lm) indiquées se réfèrent aux luminaires à corps blanc (RAL 9016). En fonction de la couleur du corps et de la longueur, celles-ci sont réduites en conséquence (se réfère uniquement aux caches en forme de U).

1 SIZE

557 mm (non-dim)	055
827 mm	082
1187 mm	118
1457 mm	145

2 COLOUR

	silver	9006
	white	9016
	black	9005
	RAL of your choice	

3 LED

	2700 K, CRI > 90	927
	3000 K, CRI > 90	930
	4000 K, CRI > 90	940
	4000 K, CRI > 80	840

4 OUTPUT / CONTROL

	low output non-dim	L1
	low output DALI	L3
	high output DALI	H3
	high output non dim (557 mm)	H1

5 OPTIC

	satiné	S
	jet black & light	J NEW
	microprism (some versions UGR < 19)	M
	U-shaped satiné, 15 mm	U
	U-shaped satiné, 34 mm	Q

P30A 1-2 P1 3 4 5

P30A082-9016P1930H3S 827 mm, white, IP44, direct, 3000 K, CRI > 90, high output DALI, satiné (order sample)

► [Configure online on KATALOG.PLANLICHT.COM](#)



Down to UGR ≤ 16 | up to 160 lm/W | up to 2692 lm/m | IEC 62471: Blue light hazard: RG 0 | DALI push switchDIM

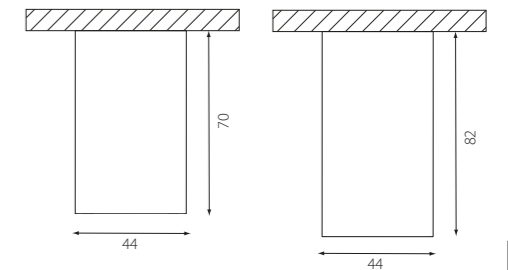
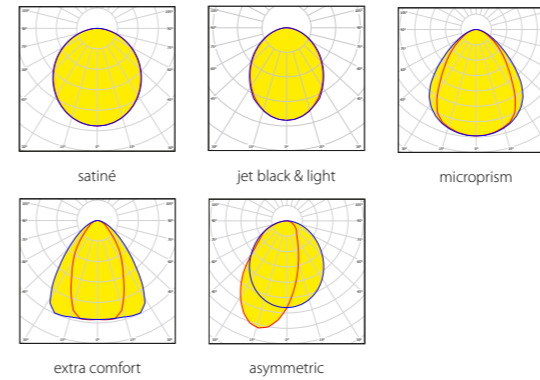

1 SIZE	2 COLOUR	3 PROFILE HEIGHT	4 LED	5 OUTPUT / CONTROL	6 OPTIC
574 mm	057 silver	9006 70 mm (p.forty seven)	830 3000 K, CRI > 80	L1 low output non-dim	S satiné
854 mm	085 white	9016 82 mm	840 4000 K, CRI > 80	L3 low output DALI	J jet black & light
1134 mm	113 black	9005	930 3000 K, CRI > 90	H3 high output DALI	M microprism*
1414 mm	141 RAL of your choice		940 4000 K, CRI > 90	X3 dynamic white	A asymmetric
1694 mm	169		HCL 2700-6500 K, dynamic white, CRI > 90		E extra comfort UGR < 19* (low output only)
2254 mm	225				
2818 mm	281				
3378 mm	337				
4498 mm	449				

0 NEW

J NEW

P40A 1-2 C 3 4 5 6

P40A141-9016C1840H3S 1414 mm, white, IP20, height 82 mm, 4000 K, CRI > 80, high output DALI, satiné (order sample)

► Configure online on KATALOG.PLANLICHT.COM

LUMINOUS FLUX (LM) / SYSTEM POWER (W)

4000K satiné	low output CRI > 80	high output CRI > 80	dynamic white CRI > 90	kg	p.forty seven
574 mm	769 lm / 7,5 W	1339 lm / 13,5 W	1014 lm / 14,5 W	1,2 kg	1,1 kg
854 mm	1185 lm / 11,5 W	2073 lm / 19,5 W	1569 lm / 19,5 W	1,6 kg	1,5 kg
1134 mm	1600 lm / 15 W	2804 lm / 24 W	2123 lm / 25 W	2,0 kg	1,9 kg
1414 mm	2014 lm / 17,5 W	3532 lm / 31 W	2674 lm / 31 W	2,6 kg	2,4 kg
1694 mm	2427 lm / 21 W	4257 lm / 37 W	3223 lm / 36 W	3,0 kg	2,8 kg
2254 mm	3250 lm / 27 W	5697 lm / 49 W	4313 lm / 48 W	3,9 kg	3,5 kg
2818 mm	4069 lm / 35 W	7123 lm / 62 W	5392 lm / 62 W	5,1 kg	4,7 kg
3378 mm	4884 lm / 41 W	8536 lm / 74 W	6462 lm / 73 W	6,0 kg	5,4 kg
4498 mm	6502 lm / 54 W	11323 lm / 98 W	8572 lm / 95 W	7,7 kg	7,0 kg

(based on optic S, DALI)

COMPARE COVER 1414 MM

	low output CRI > 80	high output CRI > 80	dynamic white CRI > 90
satiné	2014 lm	3532 lm	2674 lm
jet black & light	628 lm	1101 lm	834 lm
microprism*	2047 lm	3590 lm	2718 lm
extra comfort	2333 lm	-	-
asymmetric	1687 lm	2958 lm	2239 lm

COMPARE LIGHT COLOUR 1414 MM SATINÉ

	low output CRI > 80	
4000 K, CRI > 80	2014 lm	-1,9%
4000 K, CRI > 90	1976 lm	
3000 K, CRI > 80	1922 lm	-3,1%
3000 K, CRI > 90	1862 lm	

*Der angegebene Lichtstrom bezieht sich auf die Leuchte mit klarer mikroprismatischer Abdeckung. Die Leuchte wird mit satinierter Folie zur Erhöhung der Homogenität geliefert (-23% Lichtstrom).

The indicated luminous flux corresponds to the luminaire with a clear microprismatic diffuser. The luminaire is delivered with a satinized-foil for increased homogeneity (-23% luminous flux).

Le flux lumineux indiqué correspond au luminaire avec diffuseur microprismatique transparent. Le luminaire est livré avec un film satiné pour optimiser l'homogénéité (-23% sur le flux lumineux).

P.FORTY PROFILE SYSTEM 364

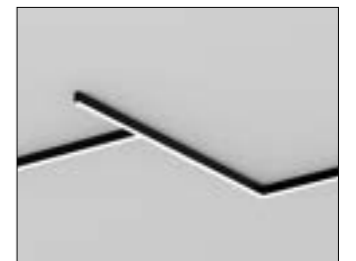

Down to UGR ≤ 19 | up to 139 lm / W | up to 2586 lm / m | IEC 62471: Blue light hazard: RG 0 | DALI switchDIM

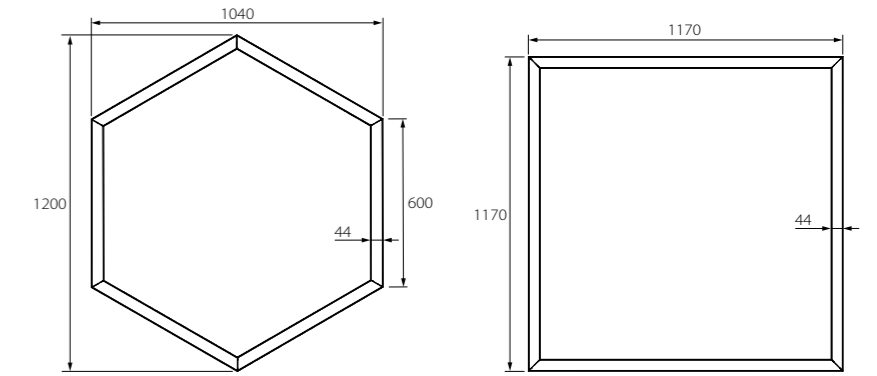
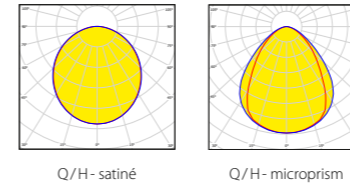

LUMINOUS FLUX (LM) / SYSTEM POWER (W)

4000K satiné	low output CRI > 80	high output CRI > 80	dynamic white CRI > 90	
1170 x 1170 mm	6400 lm / 57 W	11218 lm / 97 W	8851 lm / 99 W	9,2 kg
Ø 1200 mm	4615 lm / 43 W	8032 lm / 81 W	6337 lm / 85 W	7,6 kg

(based on optic S, DALI)

COMPARE COVER 1170 x 1170 MM

	low output CRI > 80	high output CRI > 80	dynamic white CRI > 90
satiné	6400 lm	11218 lm	8851 lm
microprism *	6506 lm	11404 lm	8998 lm

COMPARE LIGHT COLOUR 1170 x 1170 MM SATINÉ

low output CRI > 80		
4000 K, CRI > 80	6400 lm	-1,9%
4000 K, CRI > 90	6278 lm	
3000 K, CRI > 80	6108 lm	-3,1%
3000 K, CRI > 90	5916 lm	

*Der angegebene Lichtstrom bezieht sich auf die Leuchte mit klarer mikroprismatischer Abdeckung. Die Leuchte wird mit satiniertes Folie zur Erhöhung der Homogenität geliefert (-23% Lichtstrom).
The indicated luminous flux corresponds to the luminaire with a clear microprismatic diffuser. The luminaire is delivered with a satined-foil for increased homogeneity (-23% luminous flux).
Le flux lumineux indiqué correspond au luminaire avec diffuseur microprismatique transparent. Le luminaire est livré avec un film satiné pour optimiser l'homogénéité (-23% sur le flux lumineux).

1 SIZE / SHAPE

- Square (1170 x 1170 mm) **11Q**
- Hexagon (Ø 1200 mm) **12H**

2 COLOUR

- silver **9006**
- white **9016**
- black **9005**
- RAL of your choice **☛**

3 LED

- 3000 K, CRI > 80 **830**
- 4000 K, CRI > 80 **840**
- 3000 K, CRI > 90 **930**
- 4000 K, CRI > 90 **940**
- 2700 - 6500 K, dynamic white, CRI > 90 **HCL**

4 OUTPUT / CONTROL

- low output non-dim **L1**
- low output DALI **L3**
- high output DALI **H3**
- dynamic white **X3**

5 OPTIC

- satiné **S**
 - microprism* **M**
- * UGR-optimised, configure online

P40A **1 2-C1 3 4 5**

P40A11Q-9016C1840H3S square (1170 x 1170 mm), white, IP20, direct, 4000 K, CRI > 80, high output DALI, satiné (order sample)

► [Configure online on KATALOG.PLANLICHT.COM](#)

P.FORTY PROFILE SYSTEM 364

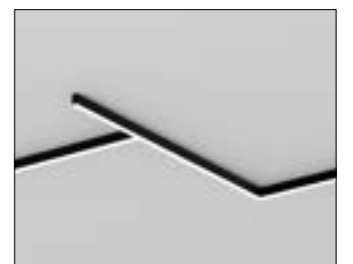

Down to UGR ≤ 19 | up to 118 lm/W | IEC 62471: Blue light hazard: RG 0 | DALI switchDIM

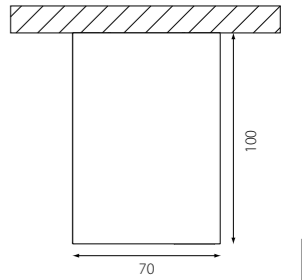
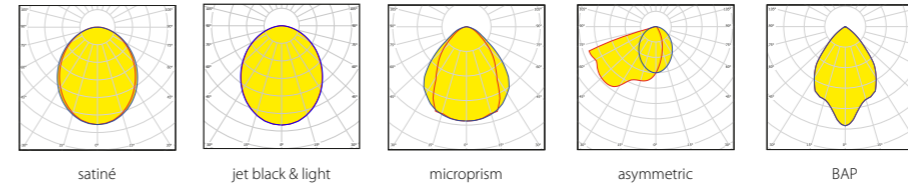
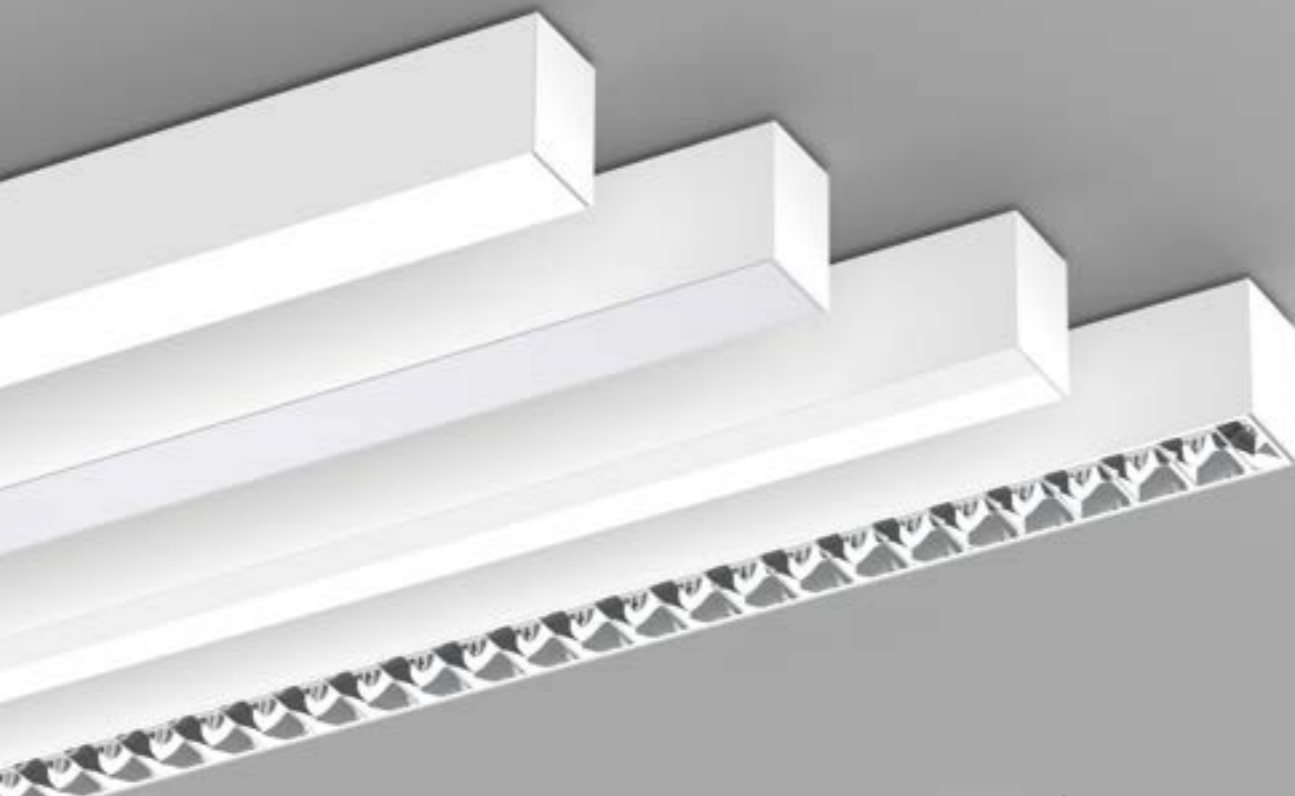

LUMINOUS FLUX (LM) / SYSTEM POWER (W)

4000K satiné	low output CRI > 80	high output CRI > 80	dynamic white CRI > 90	
574mm	735 lm / 8,2W	1328 lm / 15W	1005 lm / 16W	2,0 kg
854 mm	1126 lm / 12,5W	2033 lm / 21W	1539 lm / 22W	2,7 kg
1134 mm	1514 lm / 16,5W	2734 lm / 28W	2070 lm / 28W	3,4 kg
1414 mm	1900 lm / 19,5W	3429 lm / 35W	2596 lm / 34W	4,3 kg
1694 mm	2283 lm / 23W	4119 lm / 40W	3118 lm / 40W	5,0 kg
2254 mm	3040 lm / 30W	5485 lm / 54W	4152 lm / 52W	6,5 kg
2818 mm	3787 lm / 39W	6831 lm / 69W	5171 lm / 68W	8,5 kg
3378 mm	4522 lm / 45W	8157 lm / 81W	6175 lm / 80W	9,9 kg
4222 mm	5604 lm / 59W	10109 lm / 104W	7653 lm / 102W	12,6 kg

(based on optic S, DALI)

COMPARE COVER 1414 MM

	low output CRI > 80	high output CRI > 80	dynamic white CRI > 90
satiné	1900 lm	3429 lm	2596 lm
jet black & light	478 lm	863 lm	653 lm
microprism*	2096 lm	3782 lm	2863 lm
BAP	2168 lm	3792 lm	2402 lm
asymmetric	1857 lm	3534 lm	2045 lm

COMPARE LIGHT COLOUR 1414 MM SATINÉ, LOW OUTPUT

4000 K, CRI > 80	1900 lm	-1,9%
4000 K, CRI > 90	1875 lm	
3000 K, CRI > 80	1832 lm	-3,1%
3000 K, CRI > 90	1775 lm	

*Der angegebene Lichtstrom bezieht sich auf die Leuchte mit klarer mikroprismatischer Abdeckung. Die Leuchte wird mit satiniertes Folie zur Erhöhung der Homogenität geliefert (-28,2% Lichtstrom).

The indicated luminous flux corresponds to the luminaire with a clear microprismatic diffuser. The luminaire is delivered with a satinized foil for increased homogeneity (-28,2% luminous flux).

Le flux lumineux indiqué correspond au luminaire avec diffuseur microprismatique transparent. Le luminaire est livré avec un film satiné pour optimiser l'homogénéité (-28,2 % sur le flux lumineux).

1 VERSION

pure 3	3
pure 3.green	G NEW

2 SIZE

satiné/micro/jet black & light	asymmetric	BAP
574 mm 057	573 mm 057	-
854 mm 085	853 mm 085	-
1134 mm 113	1133 mm 113	1134 mm 113
1414 mm 141	1413 mm 141	1414 mm 141
1694 mm 169	1693 mm 169	-
2254 mm 225	2259 mm 225	2259 mm 225
2818 mm 281	2819 mm 281	2819 mm 281
3378 mm 337	3379 mm 337	3384 mm 338
4222 mm 422	4223 mm 422	4220 mm 422

3 COLOUR

	silver	9006
	white	9016
	black	9005
	RAL of your choice	

4 INGRESS PROTECTION

	IP20 (asymmetric & BAP)	C
	IP40 (satiné, microprism, jet black & light)	E

5 LED

	3000 K, CRI > 80	830
	4000 K, CRI > 80	840
	3000 K, CRI > 90	930
	4000 K, CRI > 90	940
	2700 - 6500 K dynamic white, CRI > 90	HCL

6 OUTPUT / CONTROL

	low output non-dim	L1
	low output DALI	L3
	high output DALI	H3
	dynamic white	X3

7 OPTIC

	satiné	S
	jet black & light	J NEW
	microprism*	M
	asymmetric	A
	BAP high-gloss silver*	B

*UGR-optimised, configure online

P3 1 A 2 - 3 4 1 5 6 7

P33A057 - 9016E1840H3S 574 mm, white, IP40, direct, 4000 K, CRI > 80, high output DALI, satiné (order sample)

► Configure online on [KATALOG.PLANLICHT.COM](https://www.katalog.planlicht.com)

PURE 3 PROFILE SYSTEM 378



Down to UGR ≤ 16 | up to 114 lm/W | up to 2704 lm/m | IEC 62471: Blue light hazard: RG 0 | DALI switchDIM

NEW pure 3 shapes

Aufbauleuchte
Surface lumineuse
Luminaires en saillie



PURE 3 SHAPES | SURFACE

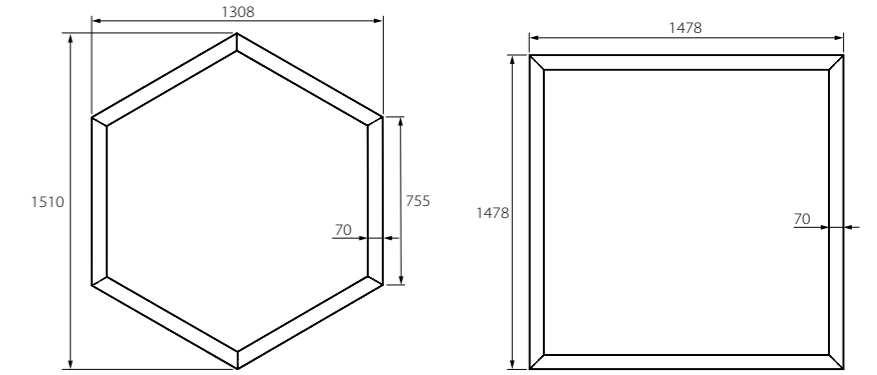
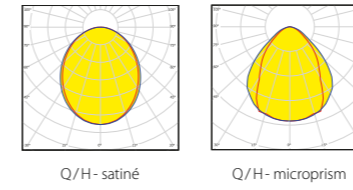

LUMINOUS FLUX (LM) / SYSTEM POWER (W)

	low output CRI > 80	high output CRI > 80	dynamic white CRI > 90	(based on DALI)
1478 x 1478 mm	7599 lm / 77 W	13716 lm / 137 W	10822 lm / 137 W	15,7 kg
Ø 1510 mm	5583 lm / 62 W	10086 lm / 112 W	7958 lm / 118 W	14,2 kg

COMPARE COVER 1478 X 1478 MM

	low output CRI > 80	high output CRI > 80	dynamic white CRI > 90
satiné	7599 lm	13716 lm	10822 lm
microprism*	8382 lm	15129 lm	11937 lm

COMPARE LIGHT COLOUR 1478 X 1478 MM SATINÉ, LOW OUTPUT

4000 K, CRI > 80	7599 lm	-1,9%
4000 K, CRI > 90	7499 lm	
3000 K, CRI > 80	7328 lm	
3000 K, CRI > 90	7100 lm	-3,1%

*Der angegebene Lichtstrom bezieht sich auf die Leuchte mit klarer mikroprismatischer Abdeckung. Die Leuchte wird mit satiniertes Folie zur Erhöhung der Homogenität geliefert (-26,4% Lichtstrom).
The indicated luminous flux corresponds to the luminaire with a clear microprismatic diffuser. The luminaire is delivered with a satinated-foil for increased homogeneity (-26,4% luminous flux).
Der angegebene Lichtstrom bezieht sich auf die Leuchte mit klarer mikroprismatischer Abdeckung. Die Leuchte wird mit satiniertes Folie zur Erhöhung der Homogenität geliefert (-26,4% Lichtstrom).

1 SIZE / SHAPE

- Square (1478 x 1478 mm) **14Q**
- Hexagon (Ø 1510 mm) **15H**

2 COLOUR

- silver **9006**
- white **9016**
- black **9005**
- RAL of your choice **☛**

3 LED

- 3000 K, CRI > 80 **830**
- 4000 K, CRI > 80 **840**
- 3000 K, CRI > 90 **930**
- 4000 K, CRI > 90 **940**
- 2700 - 6500 K dynamic white, CRI > 90 **HCL**

4 OUTPUT / CONTROL

- low output non-dim **L1**
- low output DALI **L3**
- high output DALI **H3**
- dynamic white **X3**

5 OPTIC

- satiné **S**
 - microprism* **M**
- * UGR-optimised, configure online

P33A 1-2 C1 3 4 5

P33A14Q-9016C1840H3S square (1478 x 1478 mm), white, IP20, direct, 4000 K, CRI > 80, high output DALI, satiné (order sample)

► Configure online on KATALOG.PLANLICHT.COM

PURE 3 PROFILE SYSTEM 378



Down to UGR ≤ 19 | up to 110 lm/W | IEC 62471: Blue light hazard: RG 0 | DALI switchDIM

pure 3 triflect

Aufbauleuchte
Surface luminaire
Luminaire en saillie

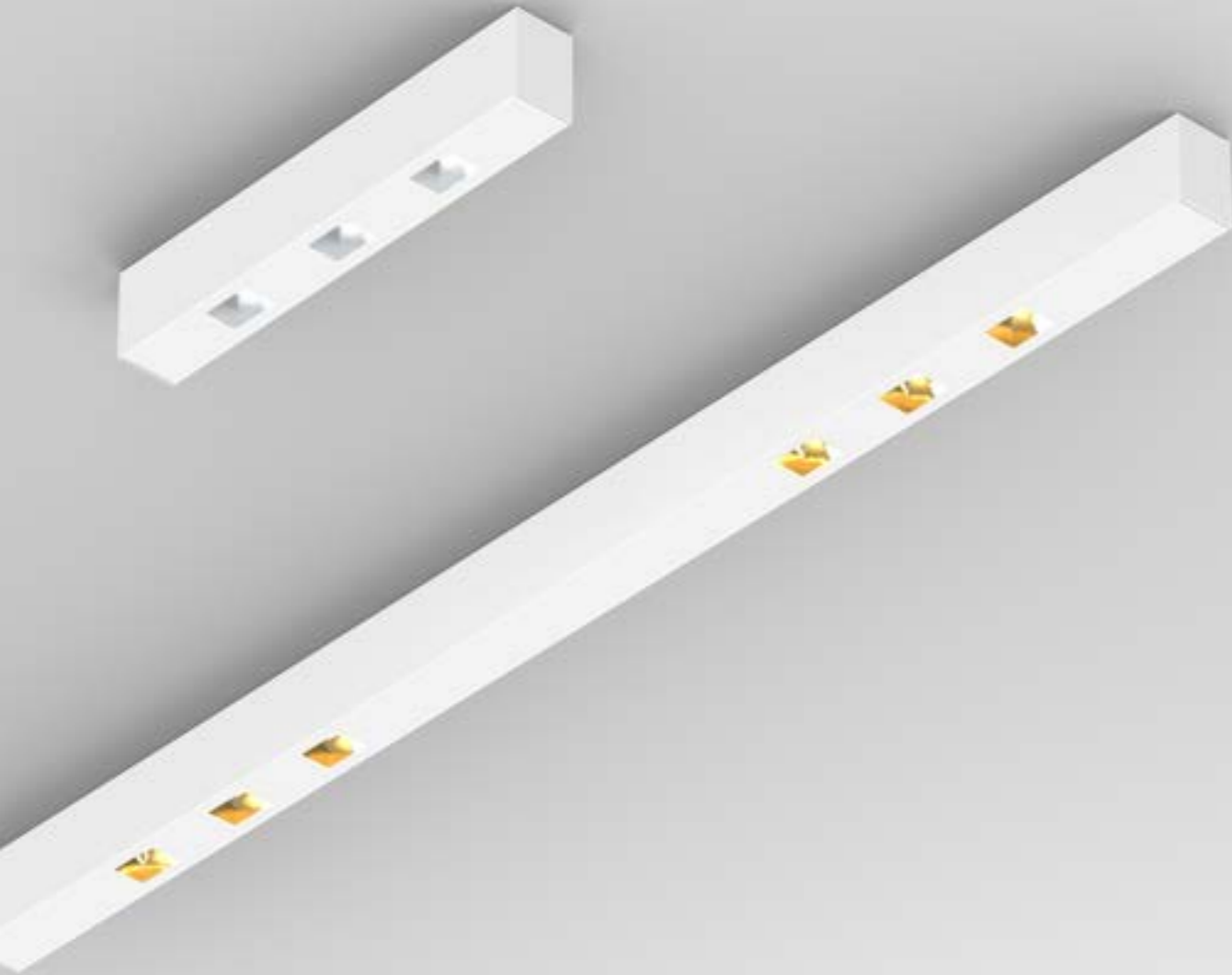

1 SIZE

575 mm (3 spots)
1801 mm (6 spots)

057
180

2 COLOUR

silver
 white
 black
 RAL of your choice

9006
9016
9005

3 OUTPUT

low output
 high output

L
H

4 CONTROL

non-dim
 DALI-dim

1
3

5 REFLECTOR

silver matte*
 high-gloss gold*

P
G

* UGR-optimised, configure online

P3TA 1-2 C1840 3 4 5

P3TA057-9016C1840H1G 575 mm, white, IP20, direct, 4000K, CRI > 80, high output, non-dim, reflector gold (order sample)

► Configure online on KATALOG.PLANLICHT.COM

PURE 3 TRIFLECT | SURFACE

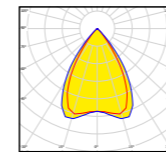

Reflector gold

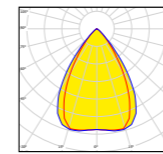

Reflector silver

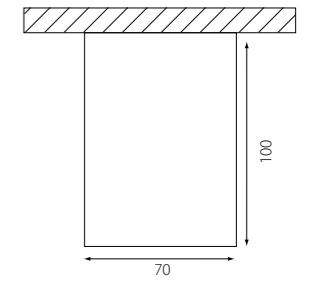
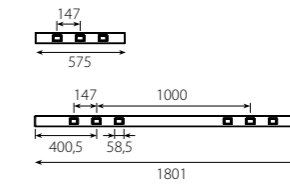

LUMINOUS FLUX (LM) / SYSTEM POWER (W)

4000K silver matte, CRI > 80	low output		high output	2,2 kg 6,0 kg (based on DALI)
	575 mm	1801 mm	1801 mm	
	1851 lm / 17,5W	3702 lm / 35W	3018 lm / 32W 6036 lm / 65W	

COMPARE REFLECTOR COLOUR 1801 MM, LOW OUTPUT

	low output	high output
silver matte	3702 lm	6036 lm
high-gloss gold	3060 lm	5112 lm



Down to UGR ≤ 16 | up to 106 lm / W | IEC 62471: Blue light hazard: RG 0 | DALI switchDIM

pure 2 IP54

Aufbauleuchte
Surface lumineuse
Luminaires en saillie

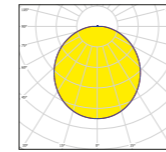
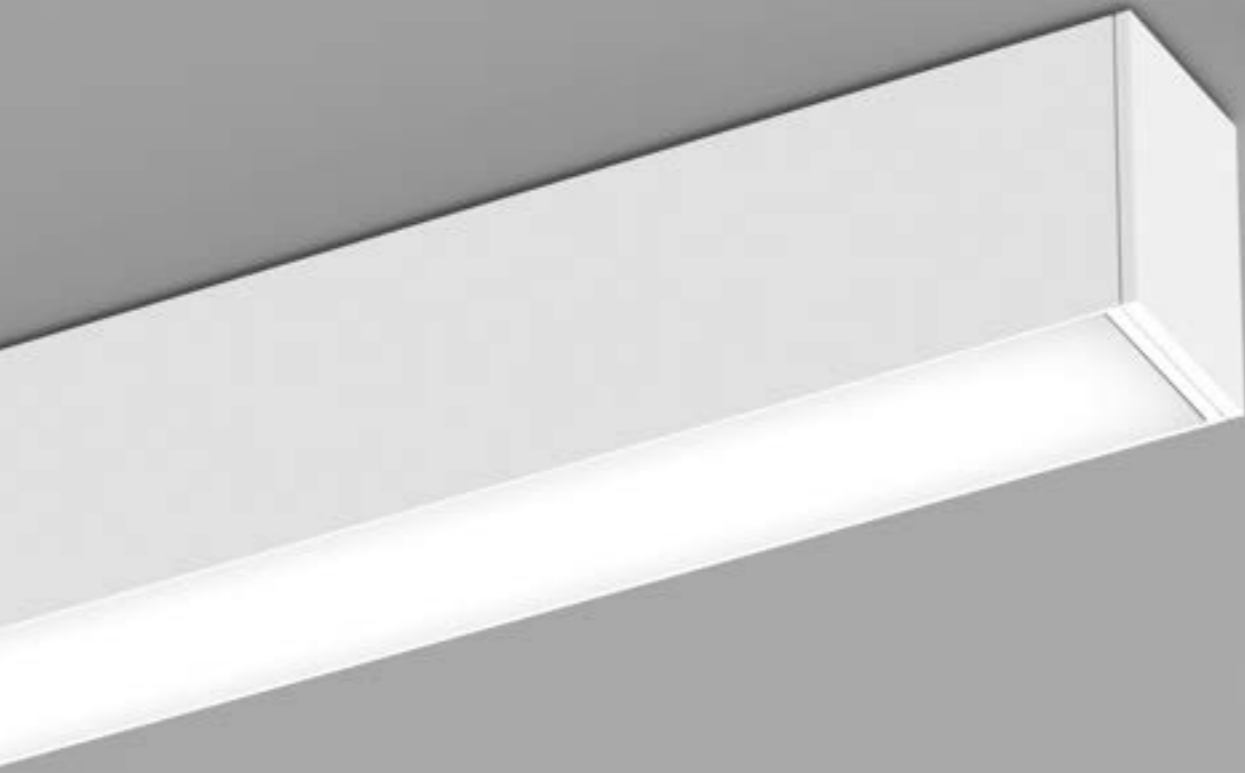

satiné

PURE 2 IP54 | SURFACE

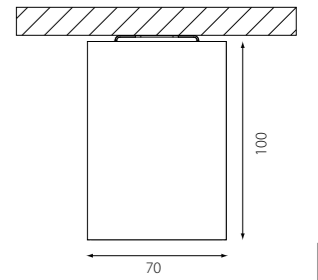

LUMINOUS FLUX (LM) / SYSTEM POWER (W)

4000K satiné	low output CRI > 80	high output CRI > 80	dynamic white CRI > 90	
600 mm	787 lm / 10W	1422 lm / 17,5W	1076 lm / 20W	2,2 kg
880 mm	1205 lm / 15,5W	2177 lm / 26W	1648 lm / 27W	3,0 kg
1160 mm	1621 lm / 20W	2927 lm / 34W	2216 lm / 35W	3,9 kg
1440 mm	2034 lm / 24W	3672 lm / 43W	2779 lm / 43W	4,9 kg
1720 mm	2444 lm / 28W	4411 lm / 50W	3339 lm / 51 W	5,7 kg
2280 mm	3255 lm / 36W	5874 lm / 66W	4446 lm / 68W	7,3 kg
2840 mm	4055 lm / 48W	7315 lm / 85W	5537 lm / 87W	9,7 kg
3400 mm	4842 lm / 56W	8734 lm / 100W	6612 lm / 102W	11,4 kg
4520 mm	6381 lm / 73W	11510 lm / 133W	8713 lm / 135W	14,8 kg

(based on DALI)





COMPARE LIGHT COLOUR 1440 MM SATINÉ

4000 K, CRI > 80	2034 lm	-1,3%
4000 K, CRI > 90	2007 lm	
3000 K, CRI > 80	1962 lm	-3,1%
3000 K, CRI > 90	1901 lm	





1 SIZE

600 mm	060
880 mm	088
1160 mm	116
1440 mm	144
1720 mm	172
2280 mm	228
2840 mm	284
3400 mm	340
4520 mm	452





2 COLOUR

	silver
	white
	black
	RAL of your choice

3 LED

	3000 K, CRI > 80	830
	4000 K, CRI > 80	840
	3000 K, CRI > 90	930
	4000 K, CRI > 90	940
	2700 - 6500 K dynamic white, CRI > 90	HCL

4 OUTPUT / CONTROL

	low output non-dim	L1
	low output DALI	L3
	high output DALI	H3
	dynamic white	X3

P58A 1-2 Q1 3 4 5

P58A060-9016Q1840H3S 600 mm, white, IP54, direct, 4000 K, CRI > 80, high output DALI, satiné (order sample)

► [Configure online on KATALOG.PLANLICHT.COM](#)



up to 90 lm/W | up to 2626 lm/m | IEC 62471: Blue light hazard: RG 0 | DALI switchDIM

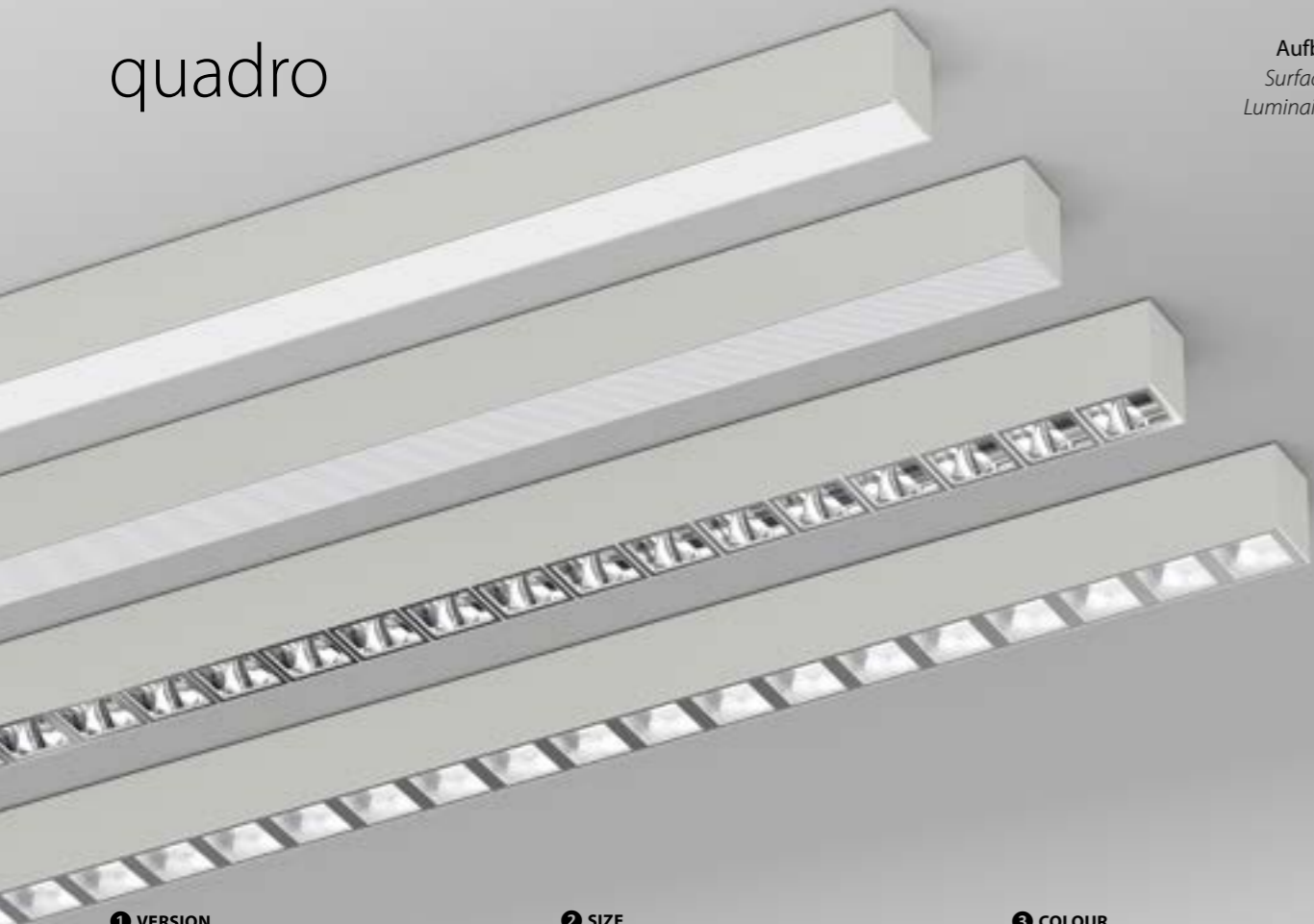

1 VERSION

quadro
NEW quadro.green

2 SIZE

Version	Size	Power (W)	Length (mm)	Weight (kg)	
BAP	BAP Sensor	112	1194 mm	119	
		140	1474 mm	147	
		168			
		224			
		280			
		336			
	satiné/microprism	satiné/microprism Sensor	113	1200 mm	120
			141	1480 mm	148
			169		
			225		
		281			
		337			

3 COLOUR

	silver	9006
	white	9016
	black	9005
	RAL of your choice	

4 LED

	3000 K, CRI > 80	830
	4000 K, CRI > 80	840
	3000 K, CRI > 90	930
	4000 K, CRI > 90	940
	2700 - 6500 K, dynamic white, CRI > 90	HCL

5 OUTPUT/CONTROL

Control	non Sensor	with Sensor
	low output non-dim L1	
	low output DALI L3	L7
	high output DALI H3	H7
	dynamic white X3	X7 (on request)

6 OPTIC

satiné	S	BAP white (RAL 9016)*	W
microprism*	M	BAP black (RAL 9005)*	N
BAP high-gloss silver*	B	BAP glaring gold*	D
BAP silver matte*	P	BAP capital copper*	R
BAP high-gloss gold*	G	BAP gunnery grey*	Y
BAP high-gloss copper*	K	BAP high gloss black chrome*	Z
	F	PLF Parabolic Louvre Flat silver semi-matte*	F

* UGR-optimised, configure online

T6 1 A 2 - 3 C1 4 5 6

T65A112-9016C1840H3B quadro, 1124 mm, white, 4000 K, CRI > 80, high output DALI, BAP high-gloss silver (order sample)

► [Configure online on KATALOG.PLANLICHT.COM](#)

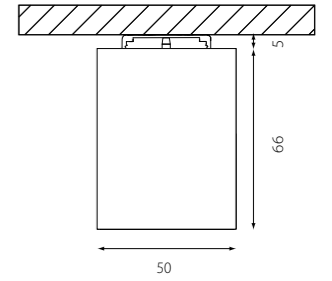
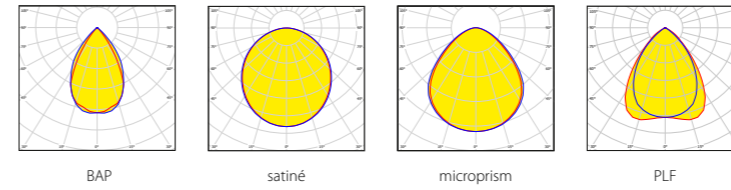

LUMINOUS FLUX (LM) / SYSTEM POWER (W)

Length (mm)	low output CRI > 80	high output CRI > 80	dynamic white CRI > 90	Weight (kg)
1124 mm	2083 lm / 19 W	4067 lm / 38 W	3227 lm / 39 W	3,0 kg
1404 mm	2603 lm / 23 W	5083 lm / 47 W	4033 lm / 48 W	3,6 kg
1684 mm	3123 lm / 27 W	6099 lm / 56 W	4839 lm / 57 W	4,5 kg
2244 mm	4163 lm / 37 W	8131 lm / 73 W	6451 lm / 74 W	6,0 kg
2804 mm	5203 lm / 46 W	10163 lm / 94 W	8063 lm / 95 W	7,5 kg
3364 mm	6244 lm / 55 W	12195 lm / 111 W	9674 lm / 113 W	9,0 kg

(based on optic BAP, DALI) (based on optic S, DALI)

COMPARE COVER 1404 MM

Optic	low output CRI > 80	high output CRI > 80	dynamic white CRI > 90
satiné	2000 lm / 16 W	3474 lm / 30 W	2630 lm / 29 W
microprism*	1580 lm / 16 W	2745 lm / 30 W	2078 lm / 29 W
high-gloss silver	3005 lm / 23 W	5869 lm / 47 W	4656 lm / 48 W
silver matte	2603 lm / 23 W	5083 lm / 47 W	4033 lm / 48 W
high-gloss gold	2748 lm / 23 W	5367 lm / 47 W	4258 lm / 48 W
high-gloss copper	2731 lm / 23 W	5334 lm / 47 W	4232 lm / 48 W
BAP white	2827 lm / 23 W	5521 lm / 47 W	4380 lm / 48 W
BAP black	1495 lm / 23 W	2920 lm / 47 W	2316 lm / 48 W
glaring gold	1749 lm / 23 W	3416 lm / 47 W	2710 lm / 48 W
capital copper	1589 lm / 23 W	3104 lm / 47 W	2463 lm / 48 W
gunnery grey	1767 lm / 23 W	3451 lm / 47 W	2738 lm / 48 W
high gloss black chrome	1767 lm / 23 W	3451 lm / 47 W	2738 lm / 48 W
parabolic louvre flat	3457 lm / 29 W	5319 lm / 47 W	4220 lm / 48 W

COMPARE LIGHT COLOUR 1414 MM BAP SILVER MATTE

4000 K, CRI > 80	5083 lm	+4,5%
4000 K, CRI > 90	5313 lm	
3000 K, CRI > 80	4850 lm	+4,5%
3000 K, CRI > 90	5068 lm	

6 BAP LOUVRE COLOURS



PROFILE VIEW



Down to UGR ≤ 16 | up to 140 lm/W | up to 4383 lm/m | IEC 62471: Blue light hazard: RG 0 | DALI switchDIM

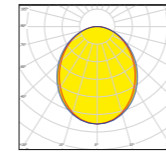

satiné

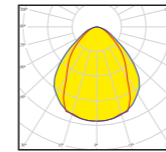

microprism

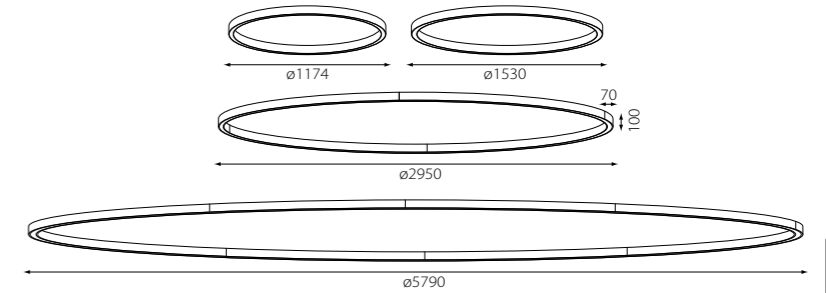

LUMINOUS FLUX (LM) / SYSTEM POWER (W)

	low output CRI > 80	high output CRI > 80	dynamic white CRI > 90	
4000K satiné				
ø 1174 mm	4901 lm / 43W	8761 lm / 81W	6632 lm / 83W	12,8 kg
ø 1530 mm	6535 lm / 57W	11681 lm / 111W	8843 lm / 109W	15,5 kg
ø 2950 mm	13070 lm / 118W	23363 lm / 222W	17686 lm / 219W	33,6 kg
ø 5790 mm	26140 lm / 236W	46725 lm / 445W	35371 lm / 437W	67,4 kg

COMPARE COVER Ø 1530 MM, 4000 K, CRI > 80

	low output CRI > 80	high output CRI > 80	dynamic white CRI > 90
satiné	6535 lm	11681 lm	8843 lm
microprism*	7031 lm	12567 lm	9514 lm

COMPARE LIGHT COLOUR Ø 1530 MM SATINÉ, LOW OUTPUT

4000 K, CRI > 80	6535 lm	-1,3 %
4000 K, CRI > 90	6448 lm	
3000 K, CRI > 80	6302 lm	-3,1 %
3000 K, CRI > 90	6106 lm	

*Der angegebene Lichtstrom bezieht sich auf die Leuchte mit klarer mikroprismatischer Abdeckung. Die Leuchte wird mit satiniertes Folie zur Erhöhung der Homogenität geliefert (-28,2% Lichtstrom).
The indicated luminous flux corresponds to the luminaire with a clear microprismatic diffuser. The luminaire is delivered with a satinated-foil for increased homogeneity (-28,2% luminous flux).
Le flux lumineux indiqué correspond au luminaire avec diffuseur microprismatique transparent. Le luminaire est livré avec un film satiné pour optimiser l'homogénéité (-28,2 % sur le flux lumineux).

1 SIZE

ø 1174 mm	117
ø 1530 mm	153
ø 2950 mm	295
ø 5790 mm	579

2 COLOUR

	silver	9006
	white	9016
	black	9005
	RAL of your choice	

3 LED

	3000 K, CRI > 80	830
	4000 K, CRI > 80	840
	3000 K, CRI > 90	930
	4000 K, CRI > 90	940
	2700 - 6500 K, dynamic white, CRI > 90	HCL

4 OUTPUT / CONTROL

	low output non-dim	L1
	low output DALI	L3
	high output DALI	H3
	dynamic white	X3

5 OPTIC

	satiné	S
	microprism*	M

* UGR-optimised, configure online

R33A 1-2 E1 3 4 5

R33A117-9016E1840H3S ø 1174 mm, white, IP40, direct, 4000 K, CRI > 80, high output DALI, satiné (order sample)

► [Configure online on KATALOG.PLANLICHT.COM](#)



Down to UGR ≤ 16 | up to 123 lm/W | IEC 62471: Blue light hazard: RG 0 | DALI switchDIM

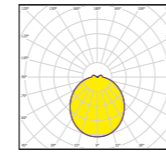

satiné

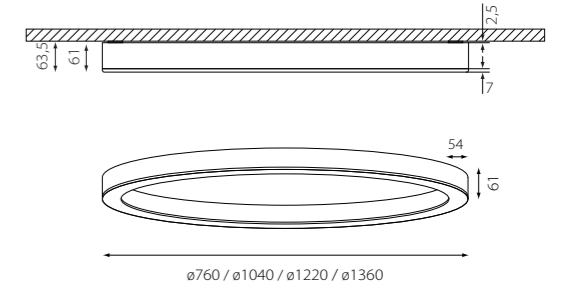

LUMINOUS FLUX (LM) / SYSTEM POWER (W), CRI > 80

	3000 K		4000 K		
	low output	high output	low output	high output	
ø 760 mm	2356 lm / 26 W	3710 lm / 41 W	2437 lm / 26 W	3837 lm / 41 W	10,0 kg
ø 1040 mm	3183 lm / 37 W	4357 lm / 51 W	3294 lm / 37 W	4509 lm / 51 W	14,0 kg
ø 1220 mm	3870 lm / 42 W	5591 lm / 62 W	4005 lm / 42 W	5786 lm / 62 W	15,0 kg
ø 1360 mm	4944 lm / 52 W	6962 lm / 74 W	5114 lm / 52 W	7200 lm / 74 W	18,0 kg

(based on DALI)

Die angegebenen Lichtstromwerte (lm) beziehen sich auf Leuchten mit einem weißen Gehäuse (RAL 9016). Unterschiedliche Gehäusefarben reduzieren diese entsprechend – silber (RAL 9006) um 21%, schwarz (RAL 9005) um 25%!

All figures of luminous flux (lm) are for fixtures with white housing (RAL 9016). Different housing colours reduce the luminous flux accordingly – silver (RAL 9006) minus 21%, black (RAL 9005) minus 25%!

Les valeurs de flux lumineux (lm) indiquées se réfèrent aux luminaires à corps blanc (RAL 9016). Différentes couleurs de corps les réduisent en conséquence – argent (RAL 9006) de 21 %, noir (RAL 9005) de 25 %!

1 SIZE

- ø 760 mm
- ø 1040 mm
- ø 1220 mm
- ø 1360 mm

- 076**
- 104**
- 122**
- 136**

2 COLOUR

- silver
- white
- black
- RAL of your choice

3 LED

- 9006** 3000 K, CRI > 80 **830**
- 9016** 4000 K, CRI > 80 **840**
- 9005** 3000 K, CRI > 90 **930**
- 940** 4000 K, CRI > 90 **940**

4 OUTPUT/CONTROL

- low output non-dim **L1**
- low output DALI **L3**
- high output DALI **H3**

R48A 1-2 C1 3 4 S

DESIGN: Nina Mair

R48A076-9016C1840H3S ø 760 mm, white, IP20, direct, 4000 K, CRI > 80, high output DALI, satiné (order sample)

► [Configure online on KATALOG.PLANLICHT.COM](#)

LATERAL DIFFUSER

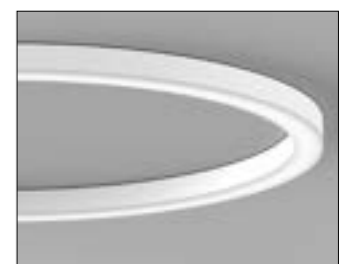

up to 98 lm/W | IEC 62471: Blue light hazard: RG 0 | DALI push switch DIM

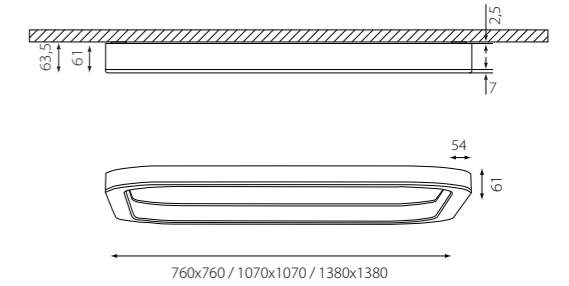
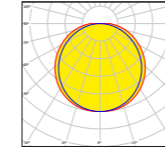

LUMINOUS FLUX (LM) / SYSTEM POWER (W)

4000 K satiné	low output CRI > 80	high output CRI > 80	dynamic white CRI > 90	
760 x 760 mm	2560 lm / 26W	4784 lm / 44W	1704 lm / 23W	6,9 kg
1070 x 1070 mm	3840 lm / 39W	7284 lm / 70W	2616 lm / 35W	14,3 kg
1380 x 1380 mm	5120 lm / 53W	9568 lm / 88W	3488 lm / 44W	18,8 kg





(based on DALI)

Die angegebenen Lichtstromwerte (lm) beziehen sich auf Leuchten mit einem weißen Gehäuse (RAL 9016). Unterschiedliche Gehäusefarben reduzieren diese entsprechend – silber (RAL 9006) um 21%, schwarz (RAL 9005) um 25%!
All figures of luminous flux (lm) are for fixtures with white housing (RAL 9016). Different housing colours reduce the luminous flux accordingly – silver (RAL 9006) minus 21%, black (RAL 9005) minus 25%!
Les valeurs de flux lumineux (lm) indiquées se réfèrent aux luminaires à corps blanc (RAL 9016). Différentes couleurs de corps les réduisent en conséquence – argent (RAL 9006) de 21 %, noir (RAL 9005) de 25 %!

1 SIZE

760 x 760 mm	07Q
1070 x 1070 mm	10Q
1380 x 1380 mm	13Q





2 COLOUR

	silver
	white
	black
	RAL of your choice

3 LED

	3000 K, CRI > 80	830
	4000 K, CRI > 80	840
	3000 K, CRI > 90	930
	4000 K, CRI > 90	940
	2700 - 6500 K dynamic white, CRI > 90	HCL

4 OUTPUT / CONTROL

	low output non-dim	L1
	low output DALI	L3
	high output DALI	H3
	dynamic white	X3

R54A 1-2 C1 3 4 S

DESIGN: Nina Mair

R54A10Q-9005C1940H3S 1070 x 1070, black, IP20, direct, 4000K, CRI > 90, high output DALI, satiné (order sample)

► [Configure online on KATALOG.PLANLICHT.COM](#)

LATERAL DIFFUSER



up to 109 lm/W | IEC 62471: Blue light hazard: RG 0 | DALI switchDIM

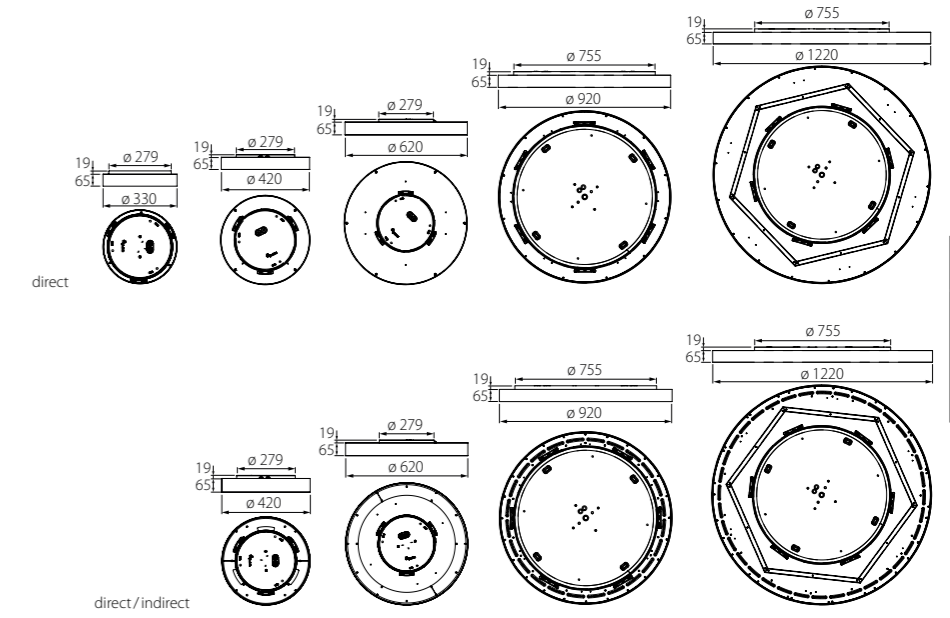
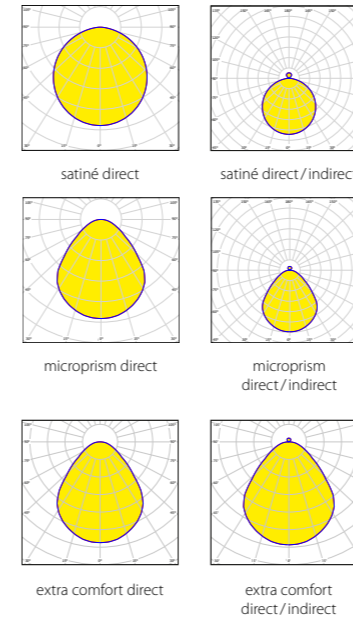

1 SIZE

ø 330 mm (direct only)	033
ø 420 mm	042
ø 620 mm	062
ø 920 mm (IP50 only)	092
ø 1220 mm (IP50 only)	122

2 COLOUR

	silver	9006
	white	9016
	black	9005
	RAL of your choice	

3 INGRESS PROTECTION

	IP50	F
	IP54 (direct only)	Q

4 DIRECT/INDIRECT

	direct	1
	direct/indirect	2

5 LED

	3000 K, CRI > 80	830
	4000 K, CRI > 80	840
	3000 K, CRI > 90	930
	4000 K, CRI > 90	940
	2700 - 6500 K dynamic white, CRI > 90	HCL

6 OUTPUT/CONTROL

	low output non-dim	L1
	low output DALI	L3
	high output DALI	H3
	very high output DALI	V3
	dynamic white	X3

7 OPTIC

	satiné	S
	microprism*	M
	extra comfort*	E

*UGR-optimised, configure online

LUMINOUS FLUX (LM) / SYSTEM POWER (W)

	direct				direct/indirect				
	4000 K satiné	low output CRI > 80	high output CRI > 80	very high output CRI > 80	dynamic white CRI > 90	low output CRI > 80	high output CRI > 80	very high output CRI > 80	dynamic white CRI > 90
ø 330 mm	962 lm / 7,4W	2180 lm / 15W	2661 lm / 18,5W	1690 lm / 15W	-	-	-	-	-
ø 420 mm	1651 lm / 11,5W	3218 lm / 22W	3993 lm / 28W	2494 lm / 22W	1788 lm / 11,5W	3484 lm / 22W	4273 lm / 28W	2700 lm / 22W	
ø 620 mm	3513 lm / 22W	6346 lm / 40W	7938 lm / 51W	4695 lm / 39W	3715 lm / 22W	6641 lm / 40W	8374 lm / 51W	4913 lm / 39W	
ø 920 mm	7500 lm / 48W	14606 lm / 93W	18682 lm / 127W	11431 lm / 94W	7811 lm / 48W	15220 lm / 93W	19473 lm / 127W	11911 lm / 94W	
ø 1220 mm	14284 lm / 95W	27748 lm / 178W	34747 lm / 229W	21716 lm / 182W	14455 lm / 95W	27965 lm / 178W	35014 lm / 229W	21886 lm / 182W	

COMPARE COVER Ø 420 MM, 4000 K, CRI > 80, LOW OUTPUT

	direct	direct/indirect
satiné	1651 lm	1788 lm
microprism*	1492 lm	1633 lm
extra comfort	1818 lm	1927 lm

WEIGHT

	direct	direct/indirect
ø 330 mm	2,0 kg	-
ø 420 mm	2,6 kg	2,7 kg
ø 620 mm	4,5 kg	4,9 kg
ø 920 mm	14,4 kg	14,7 kg
ø 1220 mm	21,9 kg	22,3 kg

(based on optic S, DALI)

*Die angegebenen Lichtstromwerte (lm) beziehen sich auf Leuchten mit einem weißen Gehäuse (RAL 9016). Je nach Gehäusefarbe reduzieren sich diese entsprechend.
All figures of luminous flux (lm) are for fixtures with white housing (RAL 9016). Depending on the housing colour, the luminous flux is reduced accordingly.
Les valeurs de flux lumineux (lm) indiquées se réfèrent aux luminaires à corps blanc (RAL 9016). En fonction de la couleur du corps, celles-ci sont réduites en conséquence.

F53A 1-2-3-4-5-6-7

F53A042-9016F1830V3S ø 420 mm, white, IP50, direct, 3000 K, CRI > 80, very high output DALI, satiné (order sample)

► Configure online on [KATALOG.PLANLICHT.COM](https://www.katalog.planlicht.com)



Down to UGR ≤ 19 | up to 169 lm/W | IEC 62471: Blue light hazard: RG 0 | DALI switchDIM

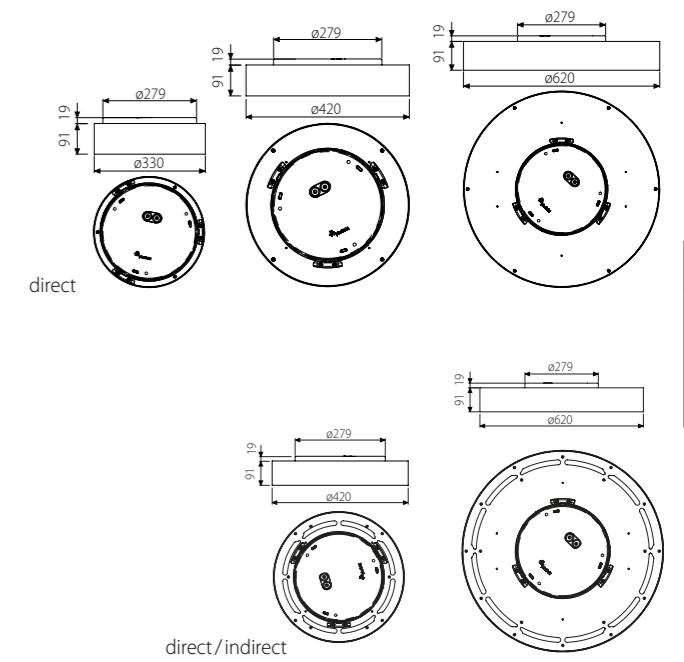
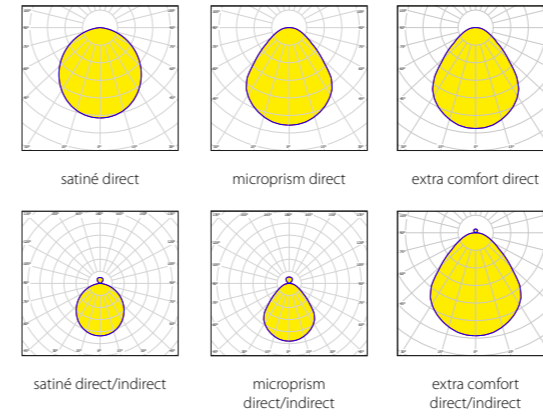

LUMINOUS FLUX (LM) / SYSTEM POWER (W)

	direct				direct / indirect				
	4000 K satiné	low output CRI > 80	high output CRI > 80	very high output CRI > 80	dynamic white CRI > 90	low output CRI > 80	high output CRI > 80	very high output CRI > 80	dynamic white CRI > 90
ø 330 mm	885 lm / 7,4 W	2036 lm / 15 W	2524 lm / 18,5 W	1578 lm / 15 W	-	-	-	-	-
ø 420 mm	1550 lm / 11,5 W	3067 lm / 22 W	3865 lm / 28 W	2377 lm / 22 W	1687 lm / 11,5 W	3333 lm / 22 W	4145 lm / 28 W	2583 lm / 22 W	
ø 620 mm	3385 lm / 22 W	6207 lm / 40 W	7884 lm / 51 W	4592 lm / 40 W	3587 lm / 22 W	6502 lm / 40 W	8320 lm / 51 W	4810 lm / 40 W	

COMPARE COVER Ø 420 MM, 4000 K, CRI > 80, LOW OUTPUT

	direct	direct / indirect
satiné	1550 lm	1687 lm
microprism*	1401 lm	1542 lm
extra comfort	1708 lm	1817 lm

WEIGHT	direct	direct / indirect
ø 330 mm	2,3 kg	-
ø 420 mm	3,0 kg	3,1 kg
ø 620 mm	5,1 kg	5,5 kg

(based on optic S, DALI)

*Die angegebenen Lichtstromwerte (lm) beziehen sich auf Leuchten mit einem weißen Gehäuse (RAL 9016). Je nach Gehäusefarbe reduzieren sich diese entsprechend.
All figures of luminous flux (lm) are for fixtures with white housing (RAL 9016). Depending on the housing colour, the luminous flux is reduced accordingly.
Les valeurs de flux lumineux (lm) indiquées se réfèrent aux luminaires à corps blanc (RAL 9016). En fonction de la couleur du corps, celles-ci sont réduites en conséquence.

1 SIZE

- ø 330 mm (direct only) **033**
- ø 420 mm **042**
- ø 620 mm **062**

2 COLOUR

	silver - silver	SISI
	black - silver	SWSI
	capital copper - black	CCSW
	glaring gold - black	DDSW
	black - black	SWSW
	capital copper - white	RRWS
	glaring gold - white	DDWS
	black - white	SWWS
	white - white	WSWS
	RAL of your choice	

housing | Gehäuse | logement
decorative ring | Zier-Ring | anneau décoratif

3 DIRECT / INDIRECT

	direct	1
	direct / indirect	2

4 LED

	3000 K, CRI > 80	830
	4000 K, CRI > 80	840
	3000 K, CRI > 90	930
	4000 K, CRI > 90	940
	2700 - 6500 K dynamic white, CRI > 90	HCL

5 OUTPUT / CONTROL

	low output non-dim	L1
	low output DALI	L3
	high output DALI	H3
	very high output DALI	V3
	dynamic white	X3

6 OPTIC

	satiné	S
	microprism*	M
	extra comfort*	E NEW

* UGR-optimised, configure online

F54A 1-2 F3 4 5 6

F54A042 - SISIF1830V35 ø 420 mm, silver decorative ring, silver housing, IP50, direct, 3000 K, CRI > 80, very high output DALI, satiné (order sample)

► [Configure online on KATALOG.PLANLICHT.COM](#)



Down to UGR ≤ 19 | up to 166 lm / W | IEC 62471: Blue light hazard: RG 0 | DALI switchDIM

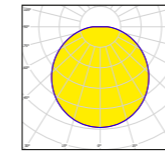

direct

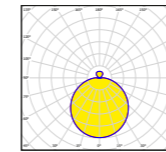

direct/indirect

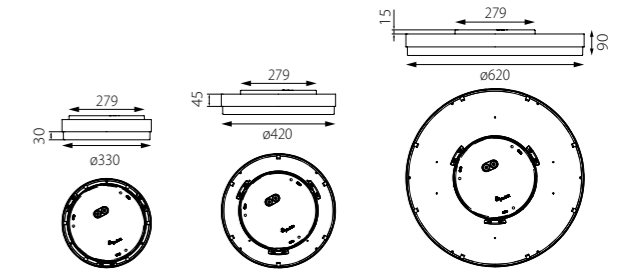

LUMINOUS FLUX (LM) / SYSTEM POWER (W)

4000 K satiné	direct			direct/indirect			kg
	low output CRI > 80	high output CRI > 80	dynamic white CRI > 90	low output CRI > 80	high output CRI > 80	dynamic white CRI > 90	
ø 330 mm	1269 lm / 10,5 W	2026 lm / 15 W	1570 lm / 15 W	1924 lm / 12,5 W	3491 lm / 22 W	2231 lm / 22 W	2,2 kg
ø 420 mm	1787 lm / 12,5 W	3225 lm / 22 W	2025 lm / 22 W	1924 lm / 12,5 W	3491 lm / 22 W	2231 lm / 22 W	3,1 kg
ø 620 mm	3400 lm / 22 W	6142 lm / 40 W	4544 lm / 39 W	3602 lm / 22 W	6437 lm / 40 W	4762 lm / 39 W	6,1 kg

*Die angegebenen Lichtstromwerte (lm) beziehen sich auf Leuchten mit einem weißen Gehäuse (RAL 9016). Je nach Gehäusefarbe reduzieren sich diese entsprechend.
All figures of luminous flux (lm) are for fixtures with white housing (RAL 9016). Depending on the housing colour, the luminous flux is reduced accordingly.
Les valeurs de flux lumineux (lm) indiquées se réfèrent aux luminaires à corps blanc (RAL 9016). En fonction de la couleur du corps, celles-ci sont réduites en conséquence.

<p>1 SIZE</p> <p>ø 330 mm (direct only) 033</p> <p>ø 420 mm 042</p> <p>ø 620 mm 062</p>	<p>2 COLOUR</p> <p>033 silver 9006</p> <p>042 white 9016</p> <p>062 black 9005</p> <p>RAL of your choice</p>	<p>3 INGRESS PROTECTION</p> <p>IP20 C</p> <p>IP54 (direct only) Q</p>
<p>4 DIRECT / INDIRECT</p> <p>direct 1</p> <p>direct/indirect 2</p>	<p>5 LED</p> <p>3000 K, CRI > 80 830</p> <p>4000 K, CRI > 80 840</p> <p>3000 K, CRI > 90 930</p> <p>4000 K, CRI > 90 940</p> <p>2700 - 6500 K, dynamic white, CRI > 90 HCL</p>	<p>6 OUTPUT / CONTROL</p> <p>low output non-dim L1</p> <p>low output DALI L3</p> <p>high output DALI H3</p> <p>dynamic white X3</p>

LATERAL DIFFUSER



F52A 1-2-3-4-5-6 S

F52A042-9016Q1840H3S ø 420 mm, white, IP54, direct, 4000 K, CRI > 80, high output DALI, satiné (order sample)

► Configure online on KATALOG.PLANLICHT.COM



Down to UGR ≤ 19 | up to 164 lm/W | IEC 62471: Blue light hazard: RG 0 | DALI switchDIM

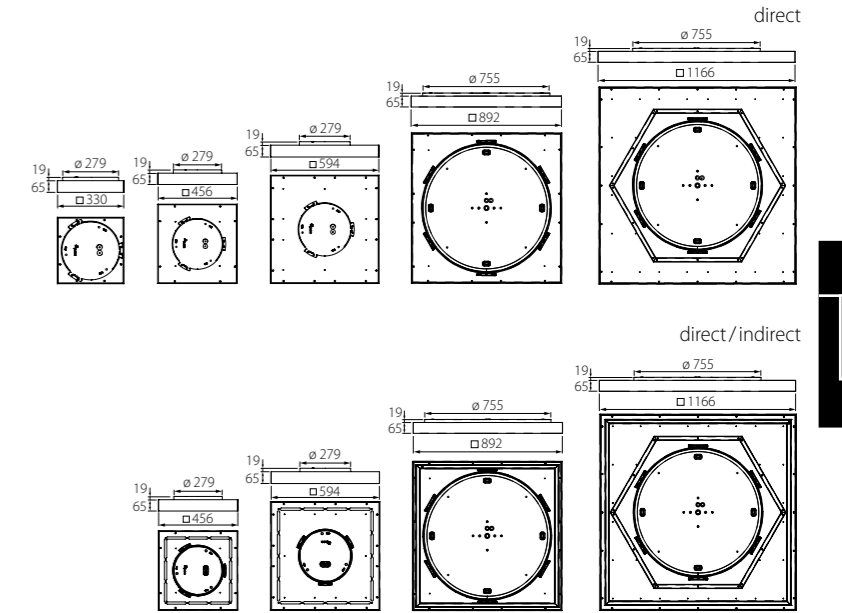
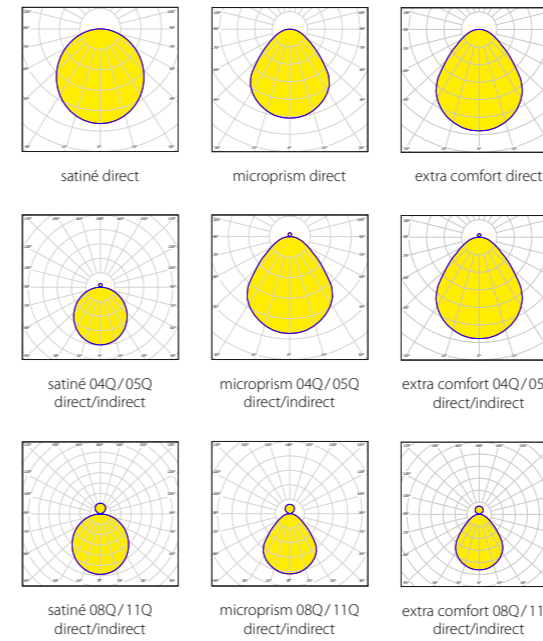

LUMINOUS FLUX (LM) / SYSTEM POWER (W)

	direct			direct / indirect			
	4000 K satiné	low output CRI > 80	high output CRI > 80	dynamic white CRI > 90	low output CRI > 80	high output CRI > 80	dynamic white CRI > 90
330 x 330 mm		1469 lm / 10,5 W	2653 lm / 18,5 W	2057 lm / 18,5 W	-	-	-
456 x 456 mm		2882 lm / 21 W	4603 lm / 33 W	3568 lm / 33 W	3041 lm / 21 W	4855 lm / 33 W	3763 lm / 33 W
594 x 594 mm		4866 lm / 31 W	9137 lm / 59 W	6269 lm / 54 W	5044 lm / 31 W	9472 lm / 59 W	6529 lm / 54 W
892 x 892 mm		10529 lm / 67 W	19379 lm / 129 W	12619 lm / 110 W	12309 lm / 80 W	22972 lm / 148 W	15404 lm / 128 W
1166 x 1166 mm		17069 lm / 111 W	33369 lm / 208 W	25868 lm / 216 W	19834 lm / 129 W	37431 lm / 242 W	29017 lm / 242 W

COMPARE COVER Ø 420 MM, 4000 K, CRI > 80, LOW OUTPUT

	direct	direct / indirect
satiné	2882 lm	3041 lm
microprism*	2501 lm	2660 lm
extra comfort	3115 lm	3238 lm

WEIGHT

	direct	direct / indirect
330 x 330 mm	2,4 kg	-
456 x 456 mm	3,6 kg	3,6 kg
594 x 594 mm	5,4 kg	5,4 kg
892 x 892 mm	16,7 kg	17,3 kg
1166 x 1166 mm	25,3 kg	25,9 kg

(based on optic S, DALI)

*Die angegebenen Lichtstromwerte (lm) beziehen sich auf Leuchten mit einem weißen Gehäuse (RAL 9016). Je nach Gehäusefarbe reduzieren sich diese entsprechend. All figures of luminous flux (lm) are for fixtures with white housing (RAL 9016). Depending on the housing colour, the luminous flux is reduced accordingly. Les valeurs de flux lumineux (lm) indiquées se réfèrent aux luminaires à corps blanc (RAL 9016). En fonction de la couleur du corps, celles-ci sont réduites en conséquence.

1 SIZE

- 330x330mm (direct only)
- 456x456mm
- 594x594mm
- 892x892mm
- 1166x1166mm

2 COLOUR

- 03Q** silver
- 04Q** white
- 05Q** black
- 08Q** RAL of your choice
- 11Q** RAL of your choice

3 DIRECT / INDIRECT

- direct **1**
- direct/indirect **2**

4 LED

- 3000 K, CRI > 80
- 4000 K, CRI > 80
- 3000 K, CRI > 90
- 4000 K, CRI > 90
- 2700 - 6500 K dynamic white, CRI > 90

5 OUTPUT / CONTROL

- low output non-dim **L1**
- low output DALI **L3**
- high output DALI **H3**
- dynamic white **X3**

6 OPTIC

- satiné **S**
- microprism* **M**
- extra comfort* **E** **NEW**

*UGR-optimised, configure online

F61A 1-2F3456

F61A04Q-9016F1830H3S 456x456mm, white, IP50, direct, 3000K, CRI > 80, high output DALI, satiné (order sample)

Configure online on KATALOG.PLANLICHT.COM



Down to UGR ≤ 19 | up to 163 lm/W | IEC 62471: Blue light hazard: RG 0 | DALI switchDIM

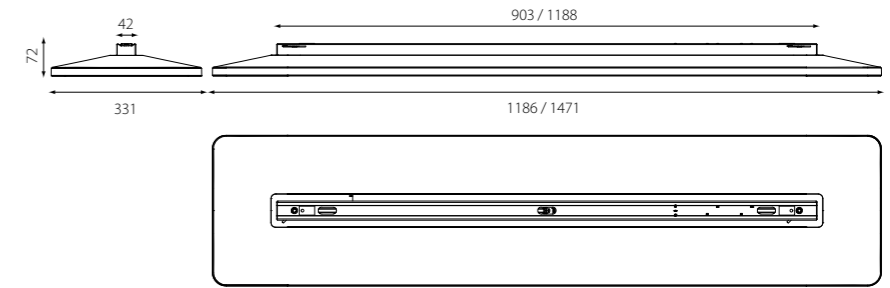
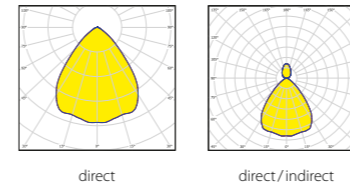
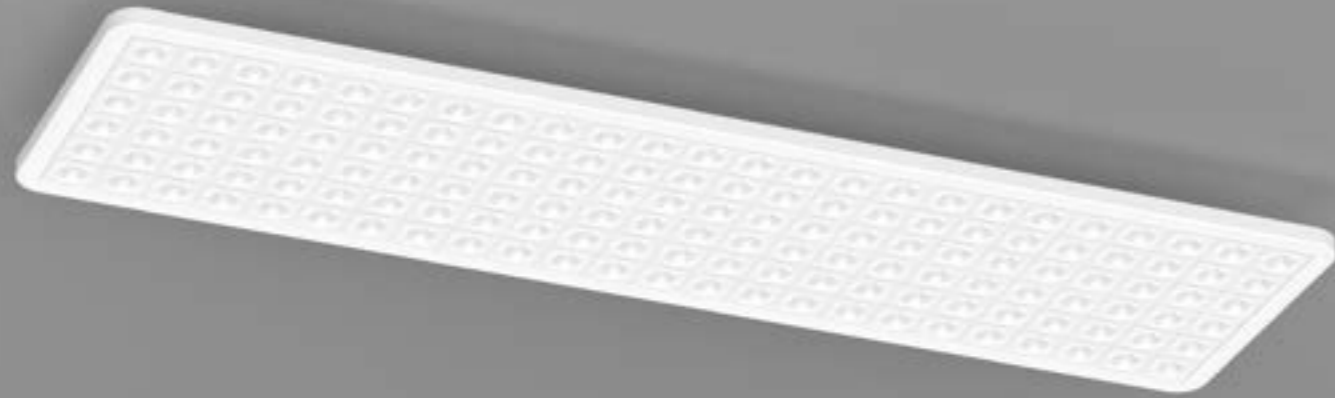

LUMINOUS FLUX (LM) / SYSTEM POWER (W)

	direct			direct/indirect			kg
	3000 K CRI > 90	4000 K CRI > 90	dynamic white CRI > 80	3000 K CRI > 90	4000 K CRI > 90	dynamic white CRI > 80	
1186 mm	2936lm/30W	3274lm/30W	3493lm/30W	4012lm/51W	4467lm/51W	4770lm/51W	8,4kg
1471 mm	3563lm/37W	3974lm/37W	4367lm/38W	4669lm/56W	5178lm/56W	5650lm/58W	9,7kg

(based on DALI)

OPTIONAL ACCESSORY - DECORATIVE FRAME

Model	Length	Finish	Control
T11-ZRA-118-SW	1186 mm	high-gloss black	non dim/DALI
T11-ZRASD-118-SW	1186 mm	high-gloss black	Sensor
T11-ZRA-147-SW	1471 mm	high-gloss black	non dim/DALI
T11-ZRASD-147-SW	1471 mm	high-gloss black	Sensor

OPTIONAL ACCESSORY FOR SENSOR LUMINAIRES

54P913700359103	Extended IR Programming Tool
54P913700392403	IR Remote Control

1 SIZE	2 COLOUR	3 DIRECT/INDIRECT
1186 mm	118 silver	direct 1
1471 mm	147 white	direct/indirect 2
	black	
	RAL of your choice	

4 LED	5 CONTROL
3000 K, CRI > 90	930 non-dim 1
4000 K, CRI > 90	940 DALI 3
2700-6500 K, dynamic white, CRI > 80	HCL Sensor (direct/indirect only not HCL) 7

T11A 1-2 C 3 4 X 5 L

T11A118-9016C2940X3L 1186 mm, white, IP20, direct/indirect, 4000 K, CRI > 90, DALI, (order sample)

► Configure online on KATALOG.PLANLICHT.COM



UGR ≤ 16 | up to 115 lm/W | IEC 62471: Blue light hazard: RG 0 | DALI switchDIM

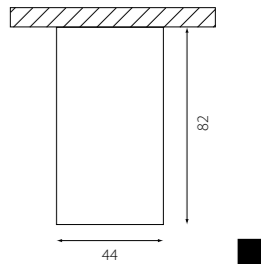
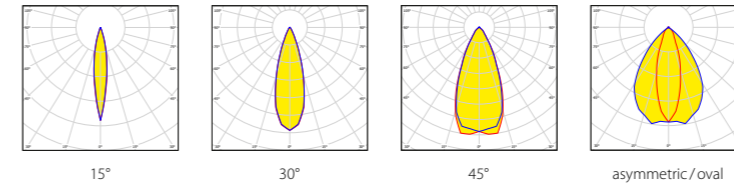
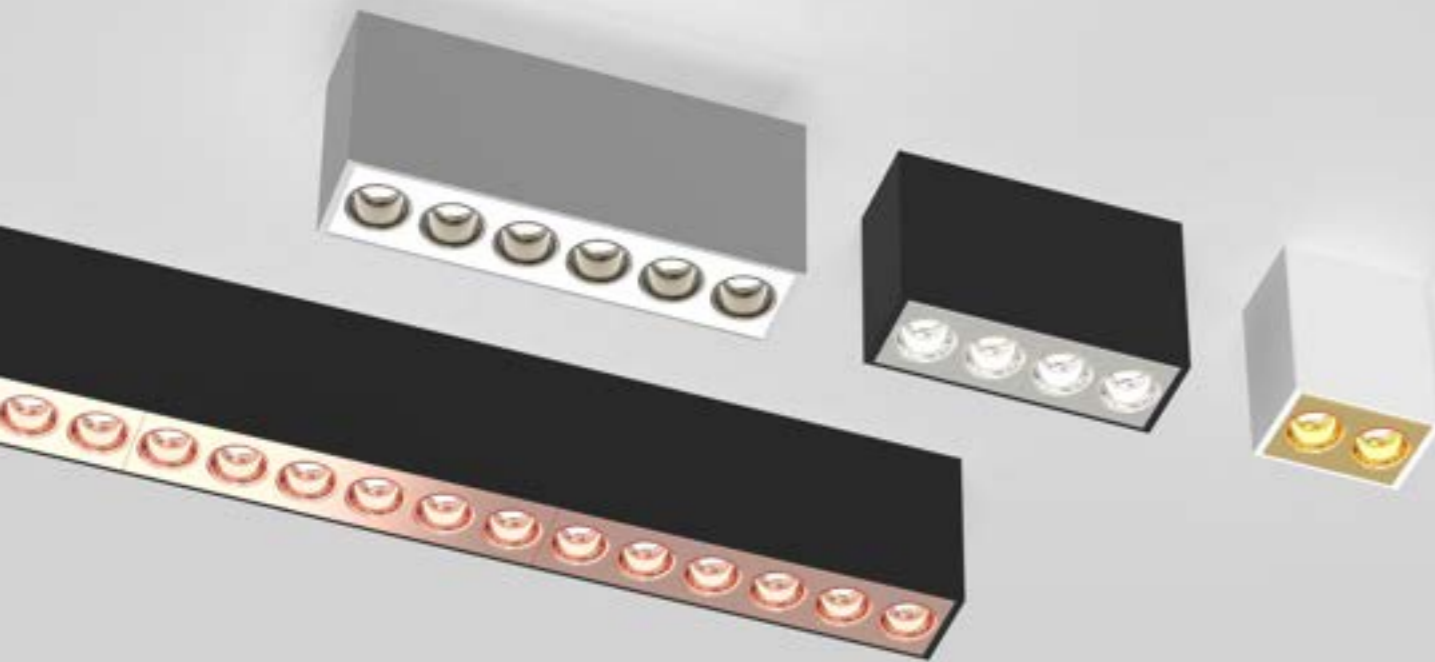

LUMINOUS FLUX (LM) ANTO+ / LENS TUBE SILVER MATTE

	2700 K CRI > 90				3000 K CRI > 90				4000 K output CRI > 90				dynamic white CRI > 90			
	15°	30°	45°	asym.	15°	30°	45°	asym.	15°	30°	45°	asym.	15°	30°	45°	asym.
2 spots	241 lm	220 lm	184 lm	193 lm	246 lm	224 lm	188 lm	197 lm	256 lm	234 lm	196 lm	205 lm				
4 spots	478 lm	435 lm	365 lm	382 lm	487 lm	444 lm	372 lm	390 lm	507 lm	463 lm	389 lm	406 lm				
6 spots	737 lm	672 lm	564 lm	590 lm	752 lm	685 lm	575 lm	602 lm	783 lm	714 lm	600 lm	627 lm				
8 spots	990 lm	901 lm	756 lm	791 lm	1008 lm	919 lm	770 lm	807 lm	1050 lm	958 lm	805 lm	840 lm				
12 spots	1526 lm	1391 lm	1167 lm	1221 lm	1557 lm	1418 lm	1190 lm	1246 lm	1621 lm	1478 lm	1242 lm	1298 lm				
18 spots	2211 lm	2016 lm	1692 lm	1770 lm	2256 lm	2055 lm	1725 lm	1806 lm	2349 lm	2142 lm	1800 lm	1881 lm	1128 lm	1028 lm	863 lm	903 lm

SYSTEM POWER (W)

	dyn. white		
2 spots	4,1 W	270 g	
4 spots	7,7 W	390 g	
6 spots	10 W	520 g	
8 spots	14 W	680 g	
12 spots	19 W	950 g	
18 spots	29 W	17 W	1310 g

(based on medium non-dim)

VARIATIONS ANTO+ SURFACE

	MEDIUM OUTPUT		DYNAMIC WHITE
	non-dim	DALI	
2 spots	●	-	-
4 spots	●	-	-
6 spots	●	-	-
8 spots	●	●	-
12 spots	●	●	-
18 spots	●	●	●

1 SIZE

2 spots - 67 mm
4 spots - 127 mm
6 spots - 187 mm
8 spots - 247 mm
12 spots - 367 mm
18 spots - 547 mm

2 TUBE COLOUR

006	high-gloss silver	B	black (RAL 9005)	N
012	silver matte	P	glaring gold	D
018	high-gloss gold	G	capital copper	R
024	high-gloss copper	K	gunnery grey	Y
036	white (RAL 9016)	W	high gloss black chrome	Z
054				

3 MASK COLOUR

high-gloss silver	B	black (RAL 9005)	N
silver matte	P	glaring gold	D
high-gloss gold	G	capital copper	R
high-gloss copper	K	gunnery grey	Y
white (RAL 9016) *	W	high-gloss black chrome	Z
UGR > 19 (only 45° 930/940)			

NEW

4 HOUSING COLOUR

	silver	SI
	white	WS
	black	SW
	RAL of your choice	

5 LED

	2700 K, CRI > 90	927
	3000 K, CRI > 90	930
	4000 K, CRI > 90	940
	2700-6500 K, dynamic white, CRI > 90 (18 spots only)	HCL

6 OUTPUT & CONTROL

	medium output, non dim	M1
	medium output, DALI	M3
	dynamic white	X3

7 BEAM

	15°	1
	30°	3
	45°	4
	asymmetric / oval	A

3 MASK COLOUR

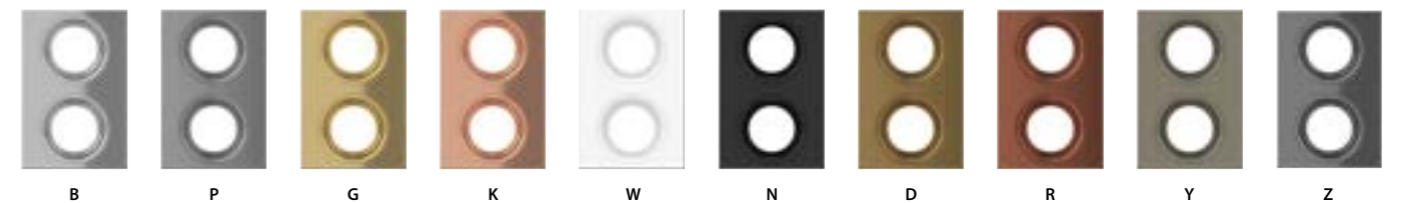

COMPARE LENS TUBES ANTO+ / SURFACE 18 SPOTS

lens tube	2700 K				3000 K				4000 K				dynamic white *			
	15°	30°	45°	asym.	15°	30°	45°	asym.	15°	30°	45°	asym.	15°	30°	45°	asym.
silver matte	2211 lm	2016 lm	1692 lm	1770 lm	2256 lm	2055 lm	1725 lm	1806 lm	2349 lm	2142 lm	1800 lm	1181 lm	1128 lm	1028 lm	863 lm	903 lm
high-gloss silver	2364 lm	2169 lm	1986 lm	2124 lm	2412 lm	2211 lm	2025 lm	2166 lm	2511 lm	2307 lm	2112 lm	2303 lm	1206 lm	1106 lm	1013 lm	1083 lm
white 9016	2307 lm	2124 lm	1848 lm	1944 lm	2352 lm	2166 lm	1884 lm	1983 lm	2451 lm	2256 lm	1965 lm	2150 lm	1177 lm	1083 lm	943 lm	991 lm
black 9005	2118 lm	1920 lm	1497 lm	1494 lm	2160 lm	1959 lm	1527 lm	1524 lm	2250 lm	2040 lm	1590 lm	1587 lm	1080 lm	979 lm	763 lm	762 lm
high-gloss gold	2349 lm	2154 lm	1983 lm	2121 lm	2397 lm	2196 lm	2022 lm	2163 lm	2496 lm	2289 lm	2109 lm	2277 lm	1198 lm	1097 lm	1011 lm	1082 lm
high gloss copper	2325 lm	2145 lm	1983 lm	2067 lm	2373 lm	2187 lm	2022 lm	2109 lm	2472 lm	2280 lm	2106 lm	2213 lm	1186 lm	1094 lm	1011 lm	1054 lm
glaring gold	2172 lm	1971 lm	1584 lm	1644 lm	2214 lm	2010 lm	1617 lm	1677 lm	2310 lm	2094 lm	1683 lm	1746 lm	1108 lm	1005 lm	808 lm	838 lm
capital copper	2151 lm	1944 lm	1512 lm	1566 lm	2193 lm	1983 lm	1542 lm	1596 lm	2286 lm	2067 lm	1608 lm	1665 lm	1097 lm	991 lm	771 lm	799 lm
gunnery grey	2202 lm	1980 lm	1590 lm	1650 lm	2247 lm	2019 lm	1623 lm	1683 lm	2340 lm	2106 lm	1689 lm	1755 lm	1123 lm	1010 lm	811 lm	842 lm
high-gloss black-chrome	2107 lm	1933 lm	1770 lm	1893 lm	2150 lm	1971 lm	1805 lm	1931 lm	2238 lm	2056 lm	1883 lm	2053 lm	1075 lm	986 lm	903 lm	965 lm

* dynamic white lumens = 2700 K, Lumens 6500 K ca. +11%

S44A 1-2 3 4 C1 5 6 7

S44A024-KYWSC1HCLX3A 8 spots, lens tube high-gloss copper, mask gunnery grey, CRI > 90, housing white, IP20, direct, asymmetric, dynamic white, CRI 90, DALI, asymmetric (order sample)

Configure online on KATALOG.PLANLICHT.COM



Down to UGR ≤ 16 | up to 94 lm/W | IEC 62471: Blue light hazard: RG ≤ 1 | DALI switchDIM

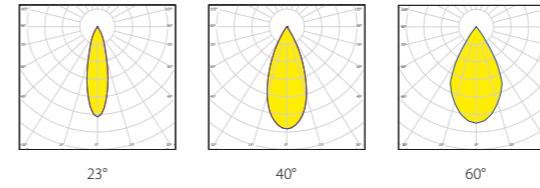

Weight (kg)
0,9 kg

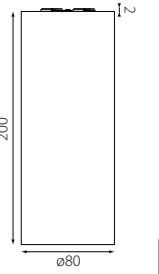

LUMINOUS FLUX (LM) / SYSTEM POWER (W)

	low output / 9,3 - 10W			medium output / 11 - 12W			high output / 17 - 18,5W			very high output / 22 - 24W		
	23°	40°	60°	23°	40°	60°	23°	40°	60°	23°	40°	60°
LF830 3000K	1112lm	1107lm	1088lm	1322lm	1316lm	1293lm	1931lm	1917lm	1884lm	2505lm	2482lm	2440lm
LF840 4000K	1180lm	1164lm	1144lm	1404lm	1384lm	1360lm	2050lm	2023lm	1988lm	2658lm	2624lm	2579lm
LF927 2700K	901lm	899lm	884lm	1072lm	1069lm	1051lm	1565lm	1565lm	1538lm	2029lm	2018lm	1983lm
LF930 3000K	944lm	952lm	936lm	1122lm	1130lm	1111lm	1629lm	1643lm	1615lm	2102lm	2120lm	2084lm
LF935 3500K	967lm	974lm	957lm	1151lm	1159lm	1139lm	1687lm	1696lm	1667lm	2196lm	2203lm	2165lm
LF940 4000K	976lm	989lm	972lm	1161lm	1175lm	1155lm	1696lm	1713lm	1684lm	2199lm	2219lm	2181lm
FAS	880lm	880lm	837lm	1047lm	1046lm	995lm	1531lm	1523lm	1449lm	1988lm	1969lm	1873lm
BAC	604lm	598lm	569lm	716lm	710lm	675lm	1038lm	1034lm	984lm	1333lm	1336lm	1271lm
FLE	604lm	598lm	569lm	717lm	710lm	675lm	1039lm	1031lm	981lm	1334lm	1328lm	1263lm
WUR	570lm	568lm	540lm	679lm	676lm	643lm	994lm	990lm	942lm	1293lm	1287lm	1224lm
FIS	924lm	924lm	879lm	1100lm	1098lm	1044lm	1608lm	1599lm	1521lm	2088lm	2067lm	1966lm
FRU	774lm	769lm	731lm	930lm	924lm	879lm	1403lm	1396lm	1328lm	1879lm	1875lm	1783lm

OPTIONAL ACCESSORY

Blendschutz-Wabenraster Honeycomb glare protection Filtre anti-éblouissement nid d'abeilles	S10-BLE-80
Ovalzeichnerlinse Refractor for elliptical distribution Lentille ovalisante	S10-OZL-80
Klares Schutzglas Clear protective glass Verre de protection transparent	S10-SGL-80
Weichzeichnerglas Diffuser protection glass Weichzeichnerglas Verre effet flou	S10-WGL-80

Reflektortausch werkzeuglos möglich. Passive Kühlung.
Replacement of the reflector without the use of any tools. Passive cooling.
Remplacement du réflecteur sans outil. Refroidissement passif.

NEW

1 TUBE COLOUR

- black matte (RAL 9005)
- high-gloss silver
- silver matte
- high-gloss black chrome
- high-gloss copper
- capital copper
- high-gloss gold
- glaring gold
- gunnery grey

2 HOUSING COLOUR

- SW** white
- BB** black
- PP** RAL of your choice
- ZZ**
- KK**
- RR**
- GG**
- DD**
- YY**

3 LED

- WS** 3000 K, CRI > 80 **830**
- SW** 4000 K, CRI > 80 **840**
- 2700 K, CRI > 90 **927**
- 3000 K, CRI > 90 **930**
- 3500 K, CRI > 90 **935**
- 4000 K, CRI > 90 **940**
- 3250 K Fashion **FAS**
- Bakery goods **BAC**
- Meat **FLE**
- Sausage products **WUR**
- Fish **FIS**
- Fruits & vegetables **FRU**

4 OUTPUT

- low output
- medium output
- high output
- very high output

5 CONTROL

- L** non-dim
- M** DALI
- H**
- V**

6 REFLECTOR

- 23° **2**
- 40° **4**
- 60° **6**

S10A200-1 2 C1 3 4 5 6

S10A200-GGWSC1FLEM34 lenstube high-gloss gold, housing white, IP20, direct, special LED, meat, medium output, DALI, 40° (order sample)

► [Configure online on KATALOG.PLANLICHT.COM](#)



Down to UGR ≤ 16 | up to 118lm/W | IEC 62471: Blue light hazard: RG ≤ 1 | DALI touch switch DIM

zenit M variable

Aufbaustrahler
Surface luminaire
Spot en saillie

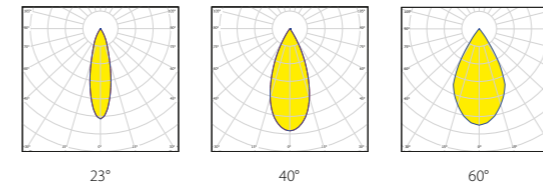

Weight (kg)
1,1 kg

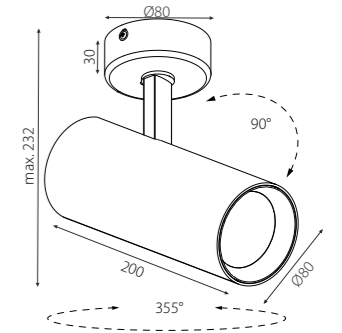

LUMINOUS FLUX (LM) / SYSTEM POWER (W)

	low output / 9,3 - 10W			medium output / 11 - 12W			high output / 17 - 18,5W			very high output / 22 - 24W		
	23°	40°	60°	23°	40°	60°	23°	40°	60°	23°	40°	60°
LF830 3000 K	1112lm	1107lm	1088lm	1322lm	1316lm	1293lm	1931lm	1917lm	1884lm	2505lm	2482lm	2440lm
LF840 4000 K	1180lm	1164lm	1144lm	1404lm	1384lm	1360lm	2050lm	2023lm	1988lm	2658lm	2624lm	2579lm
LF927 2700 K	901lm	899lm	884lm	1072lm	1069lm	1051lm	1565lm	1565lm	1538lm	2029lm	2018lm	1983lm
LF930 3000 K	944lm	952lm	936lm	1122lm	1130lm	1111lm	1629lm	1643lm	1615lm	2102lm	2120lm	2084lm
LF935 3500 K	967lm	974lm	957lm	1151lm	1159lm	1139lm	1687lm	1696lm	1667lm	2196lm	2203lm	2165lm
LF940 4000 K	976lm	989lm	972lm	1161lm	1175lm	1155lm	1696lm	1713lm	1684lm	2199lm	2219lm	2181lm
FAS	880lm	880lm	837lm	1047lm	1046lm	995lm	1531lm	1523lm	1449lm	1988lm	1969lm	1873lm
BAC	604lm	598lm	569lm	716lm	710lm	675lm	1038lm	1034lm	984lm	1333lm	1336lm	1271lm
FLE	604lm	598lm	569lm	717lm	710lm	675lm	1039lm	1031lm	981lm	1334lm	1328lm	1263lm
WUR	570lm	568lm	540lm	679lm	676lm	643lm	994lm	990lm	942lm	1293lm	1287lm	1224lm
FIS	924lm	924lm	879lm	1100lm	1098lm	1044lm	1608lm	1599lm	1521lm	2088lm	2067lm	1966lm
FRU	774lm	769lm	731lm	930lm	924lm	879lm	1403lm	1396lm	1328lm	1879lm	1875lm	1783lm

OPTIONAL ACCESSORY

Blendschutz-Wabenraster Honeycomb glare protection Filtre anti-éblouissement nid d'abeilles	S10-BLE-80
Ovalzeichnerlinse Refractor for elliptical distribution Lentille ovalisante	S10-OZL-80
Klares Schutzglas Clear protective glass Verre de protection transparent	S10-SGL-80
Weichzeichnerglas Diffuser protection glass Weichzeichnerglas Verre effet flou	S10-WGL-80

Reflektortausch werkzeuglos möglich. Passive Kühlung.
Replacement of the reflector without the use of any tools. Passive cooling.
Remplacement du réflecteur sans outil. Refroidissement passif.



1 TUBE COLOUR

- black matte (RAL 9005)
- high-gloss silver
- silver matte
- high-gloss black chrome
- high-gloss copper
- capital copper
- high-gloss gold
- glaring gold
- gunnery grey

2 HOUSING COLOUR

- SW** white
- BB** black
- PP** RAL of your choice
- ZZ**
- KK**
- RR**
- GG**
- DD**
- YY**

3 LED

- WS** 3000 K, CRI > 80 **830**
- SW** 4000 K, CRI > 80 **840**
- 2700 K, CRI > 90 **927**
- 3000 K, CRI > 90 **930**
- 3500 K, CRI > 90 **935**
- 4000 K, CRI > 90 **940**
- 3250 K Fashion **FAS**
- Bakery goods **BAC**
- Meat **FLE**
- Sausage products **WUR**
- Fish **FIS**
- Fruits & vegetables **FRU**

4 OUTPUT

- low output
- medium output
- high output
- very high output

5 CONTROL

- L** non-dim
- M** DALI
- H**
- V**

6 REFLECTOR

- 23° **2**
- 40° **4**
- 60° **6**

S10B200-1 2 C1 3 4 5 6

S10B200-GGWS1FLEM34 lenstube high-gloss gold, housing white, IP20, direct, special LED, meat, medium output, DALI, 40° (order sample)

► [Configure online on KATALOG.PLANLICHT.COM](#)



Down to UGR ≤ 16 | up to 118lm/W | up to 2658lm | IEC 62471: Blue light hazard: RG ≤ 1 | DALI touch switch DIM

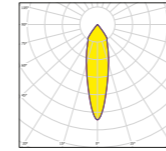

LUMINOUS FLUX (LM) / SYSTEM POWER (W)

spacetube E

	white	black	silver		
3000K CRI > 90	921 lm	914 lm	926 lm	10,5W	0,7 kg

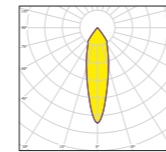

LUMINOUS FLUX (LM) / SYSTEM POWER (W)

spacetube R

	white	black	silver		
3000K CRI > 90	921 lm	879 lm	939 lm	10,5W	0,5 kg

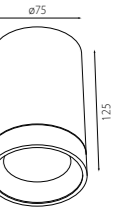
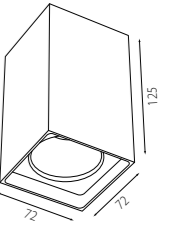

*Die angegebenen Lichtstromwerte (lm) beziehen sich auf Leuchten mit einem weißen Gehäuse (RAL 9016). Je nach Gehäusefarbe reduzieren sich diese entsprechend.
All figures of luminous flux (lm) are for fixtures with white housing (RAL 9016). Depending on the housing colour, the luminous flux is reduced accordingly.
Les valeurs de flux lumineux (lm) indiquées se réfèrent aux luminaires à corps blanc (RAL 9016). En fonction de la couleur du corps, celles-ci sont réduites en conséquence.

1 TYPE 2 COLOUR 3 LED 4 ORDER NUMBER

	spacetube R	 silver	 3000K	740118WS-V2
		 white	 3000K	740118SW-V2
		 black	 3000K	740118SI-V2
	spacetube E	 silver	 3000K	740117WS-V2
		 white	 3000K	740117SW-V2
		 black	 3000K	740117SI-V2

► Configure online on KATALOG.PLANLICHT.COM



up to 88 lm/W | IEC 62471: Blue light hazard: RG ≤ 1

spotlight 80

Aufbaustrahler
Surface luminaire
Spot en saillie



SPOTLIGHT 80 | SURFACE

 max. 50W Gu10/PAR16

LAMP GU10

54P929002495902	LED Gu10 dim	4W	2700K	345lm	36°
54P929002068302	LED Gu10 dim	4W	3000K	345lm	36°



0,1 kg

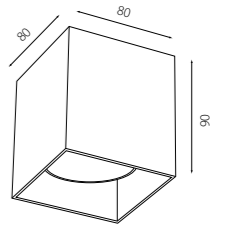

 max. 50W Gu10/PAR16

LAMP GU10





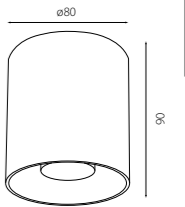

54P929002495902	LED Gu10 dim	4W	2700K	345lm	36°
54P929002068302	LED Gu10 dim	4W	3000K	345lm	36°



0,1 kg



1 TYPE 2 COLOUR 3 ORDER NUMBER

 spotlight 80R	 white	740107WS-V2
	 black	740107SW-V2
 spotlight 80E	 white	740108WS-V2
	 black	740108SW-V2

► [Configure online on KATALOG.PLANLICHT.COM](https://www.katalog.planlicht.com)

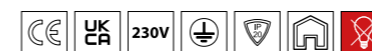

230V AC | IEC 62471: Blue light hazard: RG ≤ 1 ⇨ Lamp Gu 10

HÄNGE - LEUCHTEN

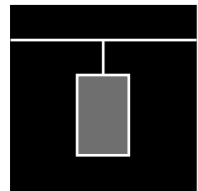

Pendant luminaires
Suspension

PROFILLEUCHTEN | PROFILE LUMINAIRES | LUMINAIRES PROFILÉS

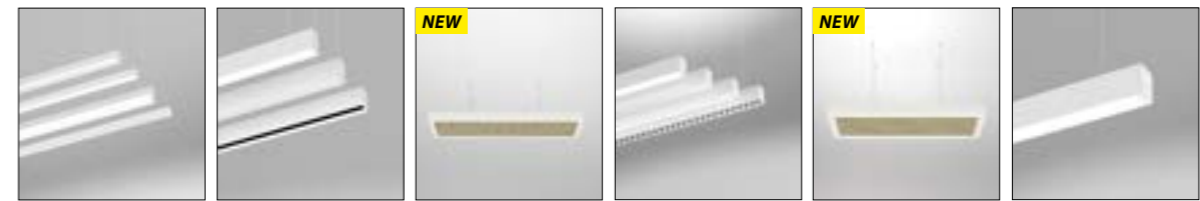

P.THIRTY
210

P.FORTY
214

NEW
P.FORTY.QUIET
218

PURE 3
220

NEW
PURE 3.QUIET
226

PURE 2 IP 54
228

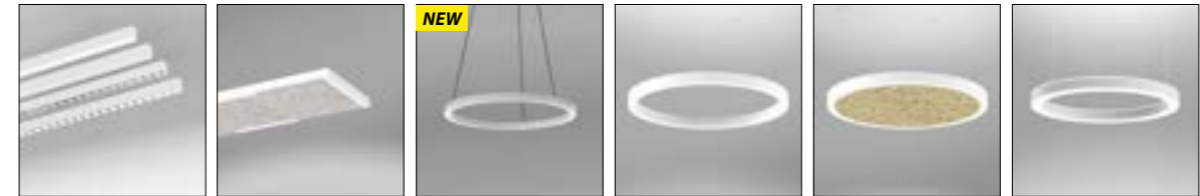

QUADRO
230

QUADRO.QUIET
234

NEW
SINUS P.THIRTY
236

SINUS
238

SINUS.QUIET
240

HALO
242



SQING
244

FLÄCHENLEUCHTEN | AREA LUMINAIRES | LAMPES DE SURFACE

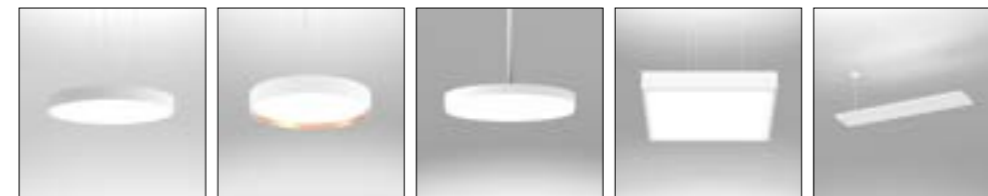

OPHELIA
246

ODELIA
248

LILIBET
250

OLMO
252

SKAI
254

DOWNLIGHTS & STRAHLER | DOWNLIGHTS & SPOTLIGHTS | DOWNLIGHTS & PROJECTEURS



ZENIT
256

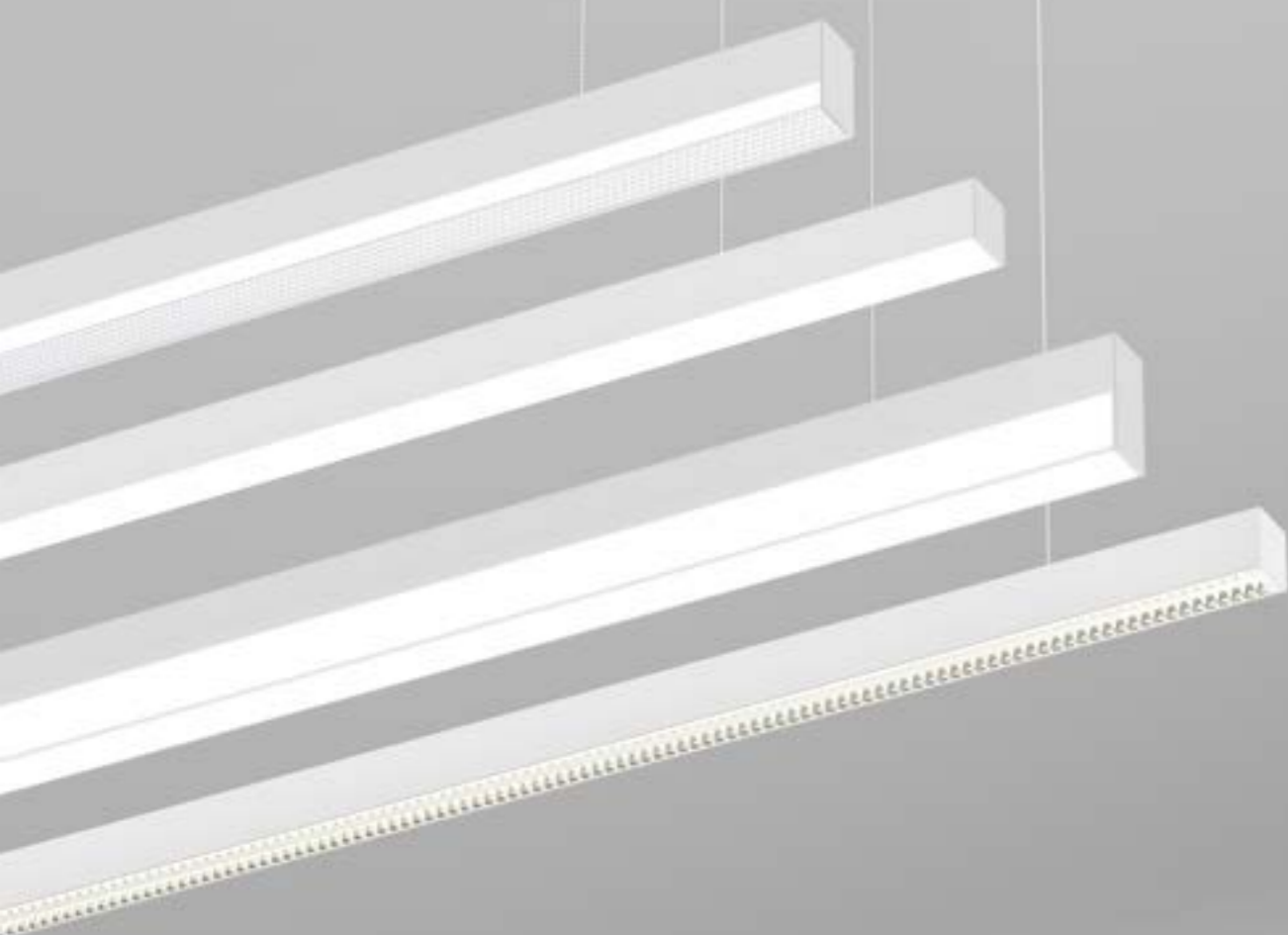

1 SIZE		2 COLOUR		3 DIRECT / INDIRECT	
1187 mm	118	black	9005	direct	1
1457 mm	145	silver	9006	direct/indirect	2
2899 mm	289	white	9016		
3531 mm	353	RAL of your choice			
4341 mm	434				
4 LED		5 OUTPUT / CONTROL		6 OPTIC	
2700 K, CRI > 90	927	DIFFUSER		satiné	S
3000 K, CRI > 90	930	low output non-dim	L1	jet black & light	J NEW
4000 K, CRI > 90	940	low output DALI	L3	microprism*	M
4000 K, CRI > 80	840	high output DALI	H3	U-shaped satiné, 15 mm	U
		OBD (Opto-Balance Darklight®)		U-shaped satiné, 34 mm	Q
		high output non dim	H1	U-shaped jet black microprism, 15 mm*	V
		high output DALI	H3	Opto-Balance Darklight* BAP high-gloss black chrome*	Z NEW
		very high output non-dim (not direct/indirect)	V1	Opto-Balance Darklight* BAP high-gloss copper*	K NEW
		very high output DALI (not direct/indirect)	V3	Opto-Balance Darklight* BAP high-gloss gold*	G NEW
				Opto-Balance Darklight* BAP high-gloss silver*	B NEW

* UGR-optimised, configure online

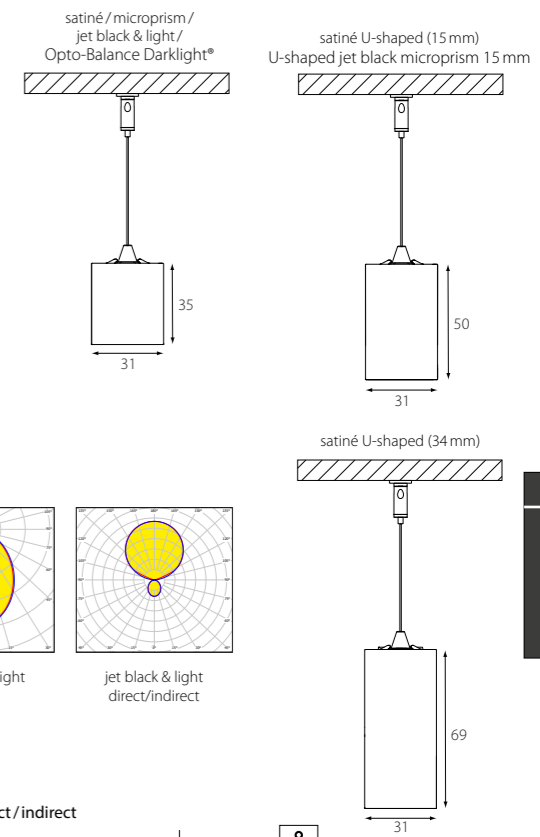
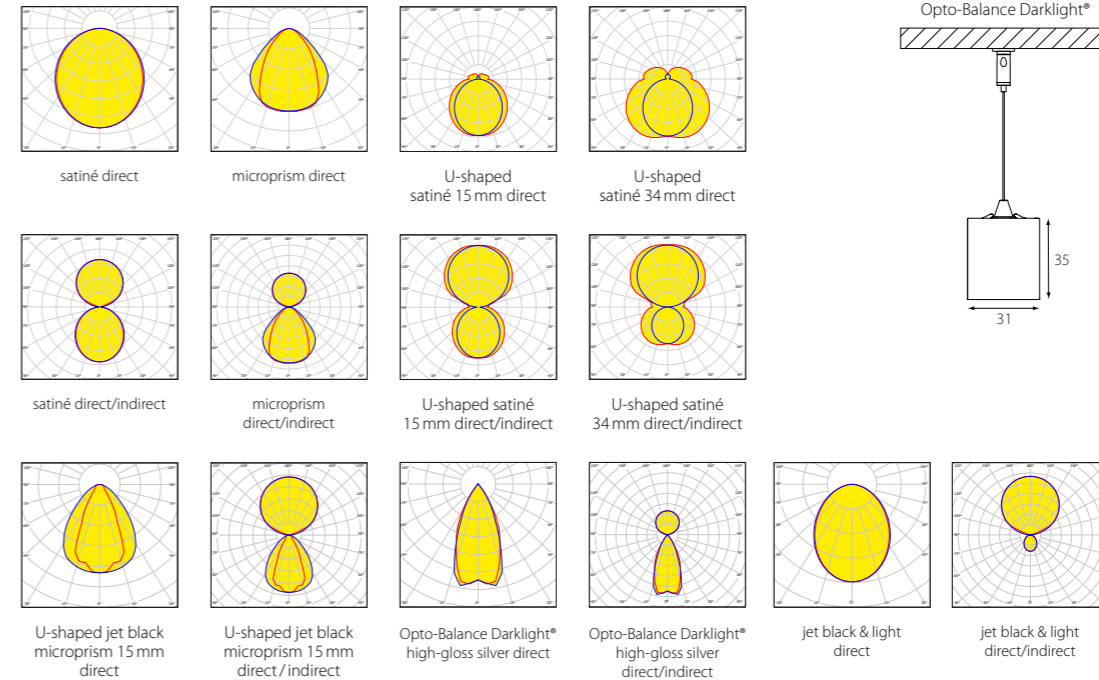

LUMINOUS FLUX (LM) / SYSTEM POWER (W), 4000 K, CRI > 80

4000 K satiné	direct			direct / indirect		weight
	low output	high output	very high output	low output	high output	
1187 mm	1999 lm / 14,5 W	2855 lm / 21 W		3755 lm / 25 W	5329 lm / 36 W	1,1 kg
1457 mm	2457 lm / 17 W	3512 lm / 25 W		4802 lm / 31 W	6818 lm / 44 W	1,3 kg
2899 mm	4895 lm / 34 W	7008 lm / 50 W		9992 lm / 63 W	14200 lm / 91 W	2,5 kg
3531 mm	5961 lm / 43 W	8537 lm / 62 W		12242 lm / 77 W	17398 lm / 112 W	3,0 kg
4341 mm	7331 lm / 51 W	10503 lm / 74 W		14992 lm / 95 W	21315 lm / 137 W	3,7 kg

(based on optic Q)

COMPARE COVER 1457 MM, 4000 K, CRI > 80

cover	low output	high output	low output	high output
satiné	2457 lm	3512 lm	4802 lm	6818 lm
jet black & light	506 lm	723 lm	4879 lm	6930 lm
microprism*	2534 lm	3624 lm	4933 lm	7015 lm
U-shaped satiné (15 mm)	2588 lm	3710 lm	5069 lm	7209 lm
U-shaped satiné (34 mm)	2724 lm	3903 lm	3764 lm	5326 lm
U-shaped jet black microprism	1419 lm	2020 lm	2851 lm	4029 lm
Opto-Balance Darklight* high-gloss silver		1941 lm	3836 lm	5102 lm

COMPARE LIGHT COLOUR 1457 MM, SATINÉ

light colour	flux
4000 K, CRI > 80	3512 lm
2700 K, CRI > 90	2637 lm
3000 K, CRI > 90	2769 lm
4000 K, CRI > 90	2862 lm

OPTIONAL ACCESSORY

PROTECTIVE COVER (INDIRECT)

P30-DIF-ID
LED-board cover, optional, reduces lumen output (max. 3,95%), sold by the metre

P.THIRTY PROFILE SYSTEM 354



*Der angegebene Lichtstrom bezieht sich auf die Leuchte mit klarer mikroprismatischer Abdeckung. Die Leuchte wird mit satinierter Folie zur Erhöhung der Homogenität geliefert (Direkt strahlend: -13,9%, direkt/indirekt strahlend: -6,9% Lichtstrom). Die angegebenen Lichtstromwerte (lm) beziehen sich auf Leuchten mit einem weißen Gehäuse (RAL 9016). Je nach Gehäusefarbe und Länge reduzieren sich diese entsprechend (bezieht sich nur auf U-förmige Abdeckungen).
The indicated luminous flux corresponds to the luminaire with a clear microprismatic diffuser. The luminaire is delivered with a satinized foil for increased homogeneity (direct -13,9%, direct/indirect: -6,9% luminous flux). All figures of luminous flux (lm) are for fixtures with white housing (RAL 9016). Depending on the housing colour and length, the luminous flux is reduced accordingly. This only applies to U-shaped optics.
Le flux lumineux indiqué correspond au luminaire avec diffuseur microprismatique transparent. Le luminaire est livré avec un film satiné pour optimiser l'homogénéité (direct: -13,9%, direct/indirect: -6,9% sur le flux lumineux). Les valeurs de flux lumineux (lm) indiquées se réfèrent aux luminaires à corps blanc (RAL 9016). En fonction de la couleur du corps et de la longueur, celles-ci sont réduites en conséquence (se réfère uniquement aux caches en forme de U).



Down to UGR ≤ 16 | IEC 62471: Blue light hazard: RG 0 | DALI push switchDIM

NEW p.thirty office special

Hängeleuchte
Pendant luminaire
Suspension

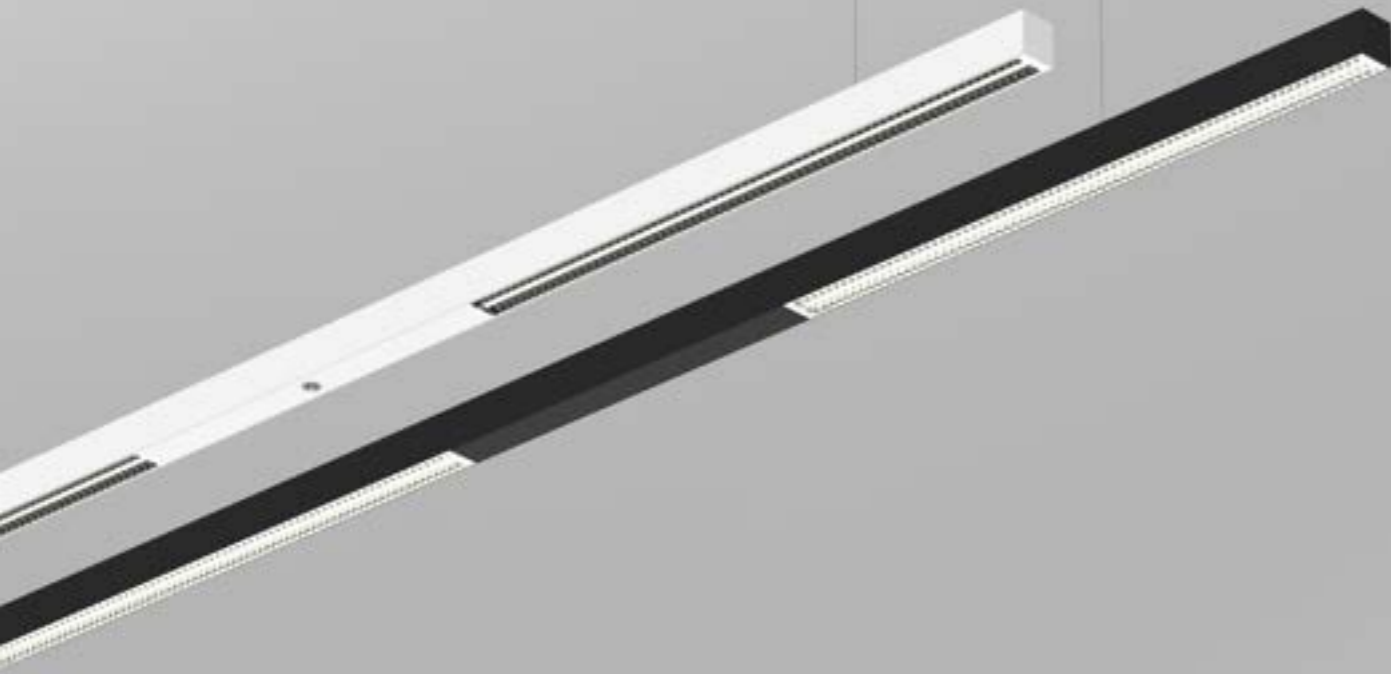

P.THIRTY OFFICE SPECIAL | PENDANT

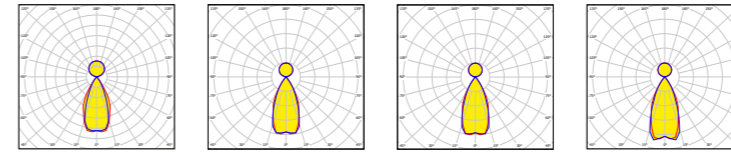

Opto-Balance Darklight® BAP high-gloss black chrome
Opto-Balance Darklight® BAP high-gloss copper
Opto-Balance Darklight® BAP high-gloss gold
Opto-Balance Darklight® BAP high-gloss silver

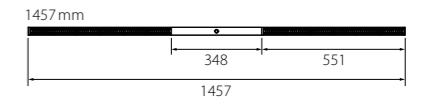
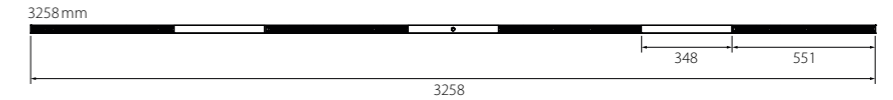
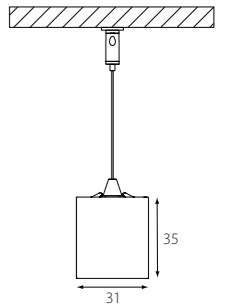

LUMINOUS FLUX (LM)/SYSTEM POWER (W), 4000 K, CRI > 0, HIGH-GLOSS SILVER

Length	very high output	Weight
1457 mm	5565 lm / 52 W	1,7 kg
3258 mm	10988 lm / 105 W	3,4 kg

COMPARE LOUVRES 1457 MM

Opto-Balance Darklight® BAP high-gloss black chrome	4817 lm
Opto-Balance Darklight® BAP high-gloss copper	5371 lm
Opto-Balance Darklight® BAP high-gloss gold	5407 lm
Opto-Balance Darklight® BAP high-gloss silver	5565 lm

P.THIRTY OFFICE SPECIAL 3258 MM

ideal for table size 3600x900 mm

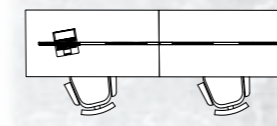
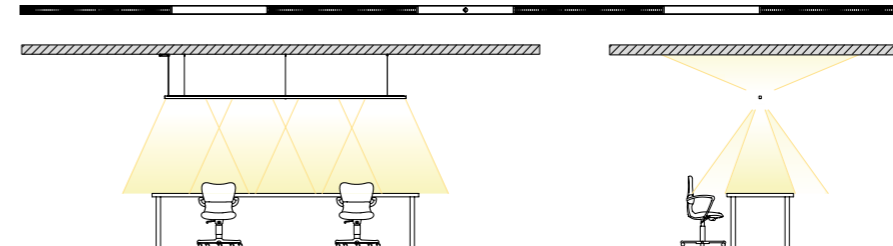

P.THIRTY OFFICE SPECIAL 1457 MM

ideal for table size 1800x900 mm

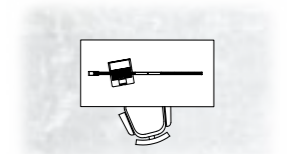
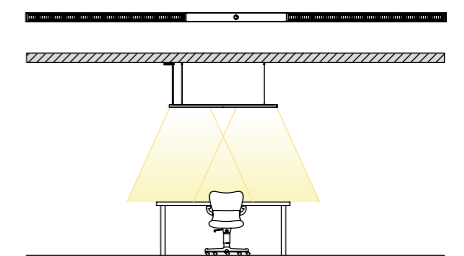

1 SIZE

1457 mm	14X
3258 mm	32X

2 COLOUR

	black	9005
	silver	9006
	white	9016
	RAL of your choice	

3 LED

	2700 K, CRI > 90	927
	3000 K, CRI > 90	930
	4000 K, CRI > 90	940
	4000 K, CRI > 80	840

4 CONTROL

	non-dim	1
	DALI	3
	Sensor DALI	7

5 OPTIC

	Opto-Balance Darklight® BAP high-gloss black chrome*	Z	NEW
	Opto-Balance Darklight® BAP high-gloss copper*	K	NEW
	Opto-Balance Darklight® BAP high-gloss gold*	G	NEW
	Opto-Balance Darklight® BAP high-gloss silver*	B	NEW

* UGR-optimised, configure online

P30H 1-2 C2 3 V 4 5

P30H14X-9016C2930V3B 1457 mm, white, IP20, direct & indirect, 3000 K, CRI > 90, very high output, DALI, Opto-Balance Darklight® high-gloss silver (order sample)

► Configure online on KATALOG.PLANLICHT.COM



Down to UGR ≤ 16 | IEC 62471: Blue light hazard: RG 0 | DALI push switchDIM

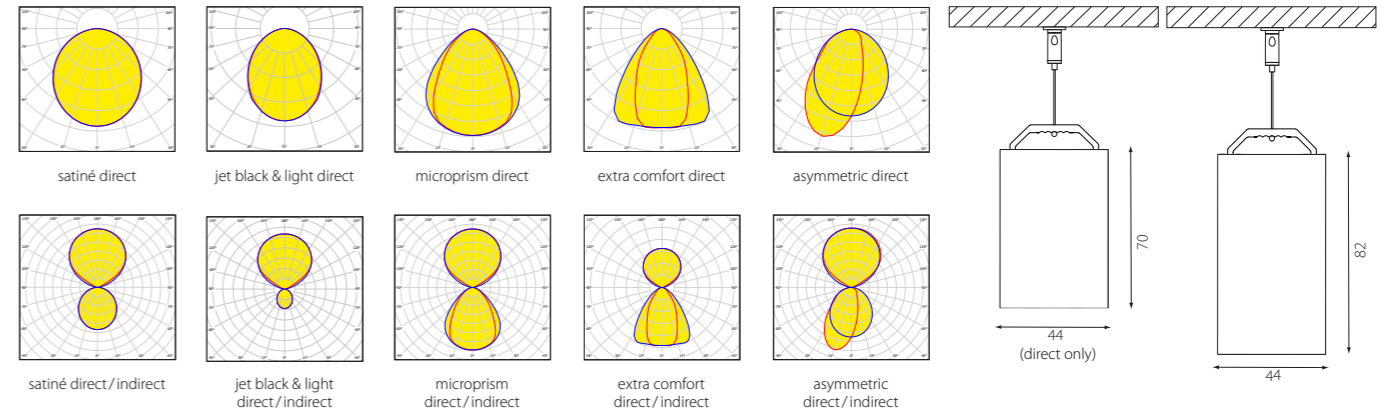

LUMINOUS FLUX (LM)/SYSTEM POWER (W)

4000K satiné	direct			KG	direct / indirect			KG
	low output CRI > 80	high output CRI > 80	dynamic white CRI > 90		low output CRI > 80	high output CRI > 80	dynamic white CRI > 90	
1134 mm	1600 lm / 15 W	2804 lm / 24 W	2123 lm / 25 W	2,6 kg	3617 lm / 27 W	6336 lm / 48 W	4797 lm / 46 W	3,0 kg
1414 mm	2014 lm / 17,5 W	3532 lm / 31 W	2674 lm / 31 W	3,1 kg	4569 lm / 33 W	8006 lm / 58 W	6061 lm / 58 W	3,5 kg
1694 mm	2427 lm / 21 W	4257 lm / 37 W	3223 lm / 36 W	3,6 kg	5519 lm / 39 W	9673 lm / 69 W	7323 lm / 72 W	4,0 kg
2254 mm	3250 lm / 27 W	5697 lm / 49 W	4313 lm / 48 W	4,4 kg	7418 lm / 52 W	12996 lm / 96 W	9838 lm / 94 W	5,0 kg
2818 mm	4069 lm / 35 W	7123 lm / 62 W	5392 lm / 62 W	5,6 kg	9312 lm / 66 W	16306 lm / 115 W	12344 lm / 115 W	6,6 kg
3378 mm	4884 lm / 41 W	8536 lm / 74 W	6462 lm / 73 W	6,5 kg	11203 lm / 78 W	19603 lm / 139 W	14840 lm / 144 W	7,7 kg
4498 mm	6502 lm / 54 W	11323 lm / 98 W	8572 lm / 95 W	8,2 kg	14972 lm / 104 W	26157 lm / 192 W	19801 lm / 188 W	9,7 kg

(based on optic S, DALI)

COMPARE COVER 1414 MM, 4000 K, CRI > 80, LOW OUTPUT

	direct			direct / indirect		
	low output CRI > 80	high output CRI > 80	dynamic white CRI > 90	low output CRI > 80	high output CRI > 80	dynamic white CRI > 90
satiné	2014 lm	3532 lm	2674 lm	4569 lm	8006 lm	6061 lm
jet black & light	628 lm	1101 lm	834 lm	3183 lm	5575 lm	4221 lm
microprism *	2047 lm	3590 lm	2718 lm	4602 lm	8064 lm	6105 lm
extra comfort	2333 lm	-	-	4888 lm	-	-
asymmetric	1687 lm	2958 lm	2239 lm	4242 lm	7432 lm	5626 lm

COMPARE LIGHT COLOUR 1414 MM, SATINÉ

4000 K, CRI > 80	2014 lm	-1,9%
4000 K, CRI > 90	1976 lm	
3000 K, CRI > 80	1922 lm	
3000 K, CRI > 90	1862 lm	-3,1%

1 SIZE

1134 mm
1414 mm
1694 mm
2254 mm
2818 mm
3378 mm
4498 mm

2 COLOUR

113
141
169
225
281
337
449

silver
white
black
RAL of your choice

3 DIRECT / INDIRECT



direct p.forty seven (Profile height 70 mm)
direct
direct / indirect

0 NEW
1
2

4 LED

3000 K, CRI > 80
4000 K, CRI > 80
3000 K, CRI > 90
4000 K, CRI > 90
2700 - 6500 K, dynamic white, CRI > 90

830
840
930
940
HCL

low output non-dim
low output DALI
high output DALI
dynamic white

6 OPTIC



satiné
jet black & light
microprism*
asymmetric
extra comfort (low output only)*

S
J NEW
M
A
E

* UGR-optimised, configure online

P40H 1-2 C 3 4 5

P40H141-9016C1840H3S pendant, 1414 mm, white, IP20, direct, 4000 K, CRI > 80, high output DALI, satiné (order sample)

Configure online on KATALOG.PLANLICHT.COM



Down to UGR ≤ 16 | up to 154 lm/W | up to 5880 lm/m | IEC 62471: Blue light hazard: RG 0 | DALI switchDIM

P.FORTY PROFILE SYSTEM 364



NEW p.forty shapes

Hängeleuchte
Pendant luminaire
Suspension



P.FORTY | PENDANT

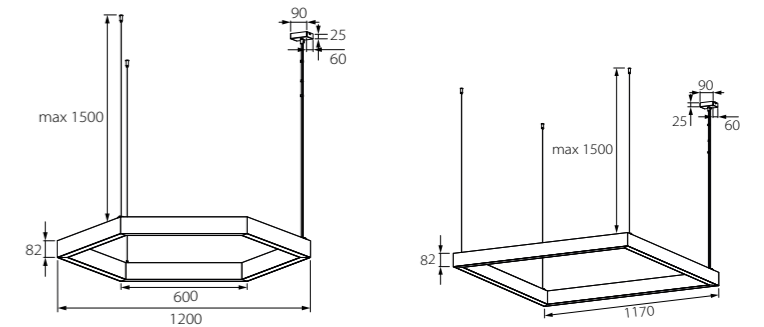
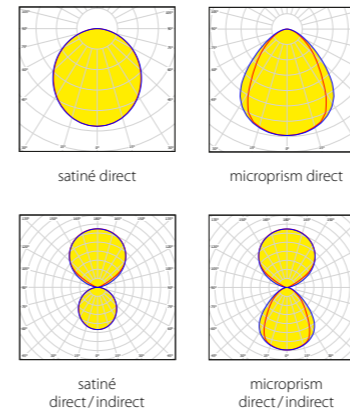

LUMINOUS FLUX (LM) / SYSTEM POWER (W)

	direct			direct/indirect			kg
	low output CRI > 80	high output CRI > 80	dynamic white CRI > 90	low output CRI > 80	high output CRI > 80	dynamic white CRI > 90	
1170 x 1170 mm	6400 lm / 57 W	11218 lm / 97 W	8851 lm / 99 W	14870 lm / 103 W	26052 lm / 195 W	20555 lm / 191 W	10,7 kg
Ø 1200 mm	4615 lm / 43 W	8032 lm / 81 W	6337 lm / 85 W	10934 lm / 86 W	19099 lm / 141 W	15174 lm / 153 W	8,8 kg

COMPARE COVER 1170 x 1170 MM, 4000 K, CRI > 80

	direct			direct/indirect		
	low output CRI > 80	high output CRI > 80	dynamic white CRI > 90	low output CRI > 80	high output CRI > 80	dynamic white CRI > 90
satiné	6400 lm	11218 lm	8851 lm	14870 lm	26052 lm	20555 lm
microprism*	6506 lm	11404 lm	8998 lm	14976 lm	26238 lm	20702 lm

COMPARE LIGHT COLOUR 1170 x 1170 MM, SATINÉ

Light Colour	Luminous Flux (lm)	Delta (%)
4000 K, CRI > 80	6400 lm	
4000 K, CRI > 90	6278 lm	-1,9%
3000 K, CRI > 80	6108 lm	
3000 K, CRI > 90	5916 lm	-3,1%

*Der angegebene Lichtstrom bezieht sich auf die Leuchte mit klarer mikroprismatischer Abdeckung. Die Leuchte wird mit satiniertes Folie zur Erhöhung der Homogenität geliefert (direkt strahlend: -22,8%, direkt/indirekt strahlend: -9,8% Lichtstrom).

The indicated luminous flux corresponds to the luminaire with a clear microprismatic diffuser. The luminaire is delivered with a satinized-foil for increased homogeneity (direct: -22,8%, direct-indirect: -9,8% luminous flux).

Le flux lumineux indiqué correspond au luminaire avec diffuseur microprismatique transparent. Le luminaire est livré avec un film satiné pour optimiser l'homogénéité (direct: -22,8%, direct-indirect: -9,8% sur le flux lumineux).

1 SIZE / SHAPE

- Square (1170 x 1170 mm) **11Q**
- ⬡ Hexagon (Ø 1200 mm) **12H**

2 COLOUR

- silver **9006**
- white **9016**
- black **9005**
- RAL of your choice

3 DIRECT / INDIRECT

- ☀ direct **1**
- ☀☁ direct/indirect **2**

4 LED

- 3000 K, CRI > 80 **830**
- 4000 K, CRI > 80 **840**
- 3000 K, CRI > 90 **930**
- 4000 K, CRI > 90 **940**
- 2700 - 6500 K, dynamic white, CRI > 90 **HCL**

5 OUTPUT / CONTROL

- ☀☁ low output non-dim **L1**
- ☀☁ low output DALI **L3**
- ☀☁ high output DALI **H3**
- ☀☁ dynamic white **X3**

6 OPTIC

- satiné **S**
- microprism* **M**

* UGR-optimised, configure online

P40H 1 2-C 3 4 5 6

P40H11Q-9016C1840H3S pendant, square, 1170 x 1170 mm, white, IP 20, 4000 K, CRI > 80, high output DALI, satiné (order sample)

➔ Configure online on KATALOG.PLANLICHT.COM

P.FORTY PROFILE SYSTEM 364



Down to UGR ≤ 16 | up to 145 lm/W | IEC 62471: Blue light hazard: RG 0 | DALI switchDIM

NEW

p.forty.quiet

Hängeleuchte
Pendant luminaire
Suspension



1 SIZE

1485 x 657 mm	14R
1765 x 657 mm	17R
3445 x 657 mm	34R

2 ACOUSTIC MODULE

QUIET.FELT standard anthracite melange	QA
QUIET.FELT standard pebble	QP
QUIET.FELT standard lime	QL
QUIET.FELT extra+ black *	QB
QUIET.FELT extra+ fire *	QF
QUIET.FELT extra+ light grey melange *	QG
QUIET.FELT extra+ chocolate *	QC
Organoid* Mous *	QM
Organoid* Wollä *	QW
Organoid* Wildspitze *	QH

*on request

3 HOUSING COLOUR

silver	SI
white	WS
black	SW
RAL of your choice	

4 DIRECT / INDIRECT

direct	1
direct / indirect	2

5 LED

3000 K, CRI > 80	830
4000 K, CRI > 80	840
3000 K, CRI > 90	930
4000 K, CRI > 90	940
2700 - 6500 K dynamic white, CRI > 90	HCL

6 OUTPUT / CONTROL

low output non-dim	L1
low output DALI	L3
high output DALI	H3
dynamic white	X3

7 OPTIC

satiné	S
microprism*	M

*UGR-optimised, configure online

P40H 1-2 C 3 4 5 6 7

P40H14R-QAWSC1840H3S pendant, quiet, 1485 x 657 mm, acoustic module anthracite melange, housing white, 4000K, CRI > 80, high output DALI, satiné (order sample) [Configure online on KATALOG.PLANLICHT.COM](#)

P.FORTY.QUIET | PENDANT

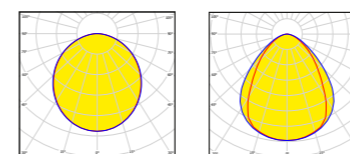

satiné direct microprism direct

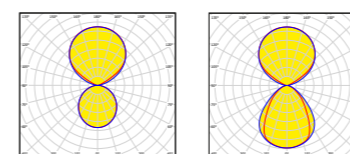

satiné direct / indirect microprism direct / indirect

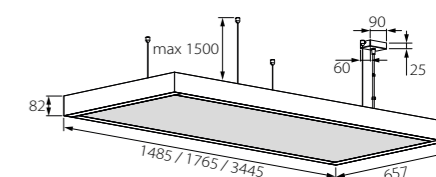

LUMINOUS FLUX (LM) / SYSTEM POWER (W)

	direct			direct / indirect			KBA	
	4000K satiné	low output CRI > 80	high output CRI > 80	dynamic white CRI > 90	low output CRI > 80	high output CRI > 80		dynamic white CRI > 90
1485 x 657 mm		4028 lm / 32 W	7065 lm / 62 W	5574 lm / 62 W	9405 lm / 67 W	16484 lm / 120 W	13006 lm / 120 W	14,3 kg
1765 x 657 mm		4884 lm / 40 W	8514 lm / 74 W	6718 lm / 73 W	11337 lm / 76 W	19816 lm / 141 W	15635 lm / 141 W	17,4 kg
3445 x 657 mm		9707 lm / 79 W	17029 lm / 149 W	13436 lm / 145 W	22617 lm / 152 W	39634 lm / 281 W	31271 lm / 282 W	31,3 kg

COMPARE COVER 1170 x 1170 MM, 4000 K, CRI > 80

	direct			direct / indirect		
	low output CRI > 80	high output CRI > 80	dynamic white CRI > 90	low output CRI > 80	high output CRI > 80	dynamic white CRI > 90
satiné	4028 lm	7065 lm	5574 lm	9405 lm	16484 lm	13006 lm
microprism *	4095 lm	7182 lm	5667 lm	9472 lm	16601 lm	13098 lm

COMPARE LIGHT COLOUR 1170 x 1170 MM, SATINÉ

4000 K, CRI > 80	4028 lm	-1,9%
4000 K, CRI > 90	3951 lm	-1,9%
3000 K, CRI > 80	3844 lm	-3,1%
3000 K, CRI > 90	3723 lm	-3,1%

*Der angegebene Lichtstrom bezieht sich auf die Leuchte mit klarer mikroprismatischer Abdeckung. Die Leuchte wird mit satiniertes Folie zur Erhöhung der Homogenität geliefert (direkt strahlend: -22,8%, direkt/indirekt strahlend: -9,8% Lichtstrom).

The indicated luminous flux corresponds to the luminaire with a clear microprismatic diffuser. The luminaire is delivered with a satiné-foil for increased homogeneity (direct: -22,8%, direct-indirect: -9,8% luminous flux).

Le flux lumineux indiqué correspond au luminaire avec diffuseur microprismatique transparent. Le luminaire est livré avec un film satiné pour optimiser l'homogénéité (direct: -22,8%, direct-indirect: -9,8% sur le flux lumineux).

ACOUSTIC ABSORBERS

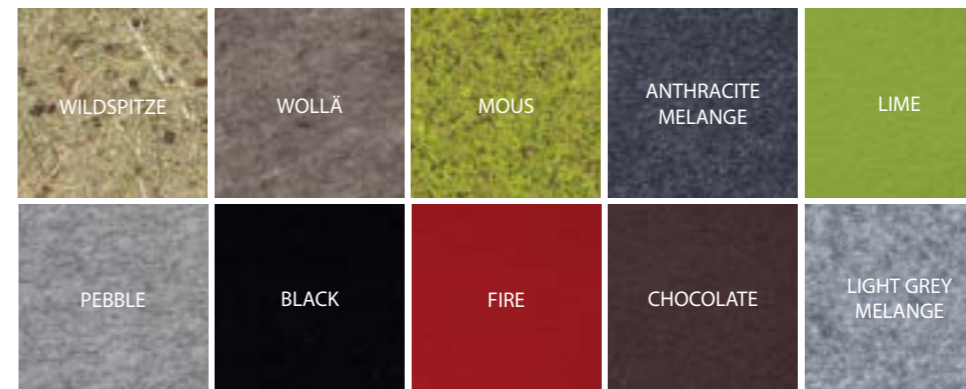

Down to UGR ≤ 16 | up to 150 lm / W | IEC 62471: Blue light hazard: RG 0 | DALI switchDIM

pure 3

Hängeleuchte
Pendant luminaire
Suspension



1 VERSION

pure 3
NEW pure 3.green

3
G

2 SIZE

	satiné/jet black & light/micro-prism/green		asymmetric		BAP	
1134 mm	113	1133 mm	113	1134 mm	113	
1414 mm	141	1413 mm	141	1414 mm	141	
1694 mm	169	1693 mm	169	-	-	-
2254 mm	225	2259 mm	225	2259 mm	225	
2818 mm	281	2819 mm	281	2819 mm	281	
3378 mm	337	3379 mm	337	3384 mm	338	
4222 mm	422	4223 mm	422	4220 mm	422	

3 COLOUR

silver
white
black
RAL of your choice

9006
9016
9005

6 LED

3000 K, CRI > 80
4000 K, CRI > 80
3000 K, CRI > 90
4000 K, CRI > 90
2700-6500 K, dynamic white, CRI > 90

830
840
930
940
HCL

4 INGRESS PROTECTION

IP20 (asymmetric & BAP)
IP40 (satiné, jet black & light, microprism)

C
E

5 DIRECT / INDIRECT

direct
direct / indirect

1
2

7 OUTPUT / CONTROL

low output non-dim
low output DALI
high output DALI
dynamic white

L1
L3
H3
X3

8 OPTIC

satiné
jet black & light
microprism*
asymmetric
BAP high-gloss silver*

NEW

* UGR-optimised, configure online

P3 1 H 2 - 3 4 5 6 7 8

P33H113-9016E1840H3S pendant, pure 3, 1134 mm, white, IP40, direct, 4000 K, CRI > 80, high output DALI, satiné, IP40 (order sample) > Configure online on KATALOG.PLANLICHT.COM

PURE 3 | PENDANT

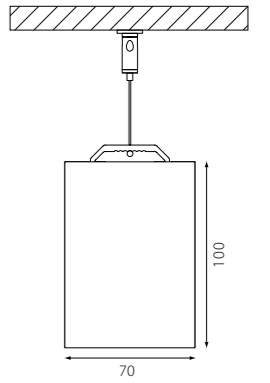
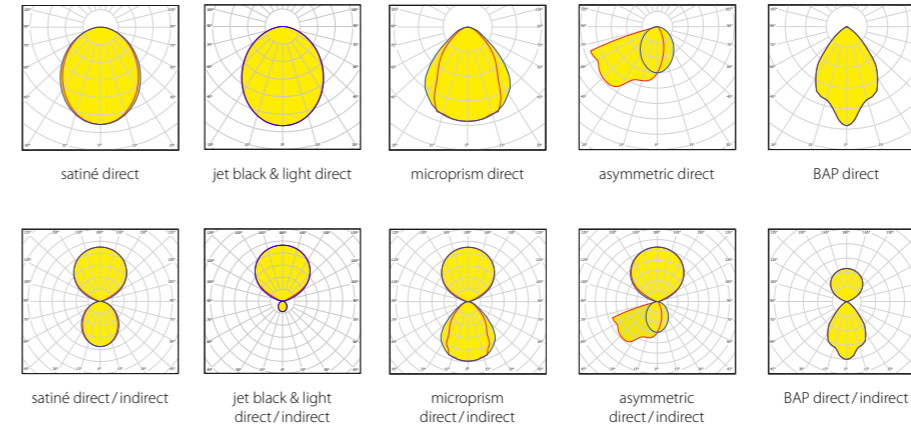

LUMINOUS FLUX (LM) / SYSTEM POWER (W)

	direct			direct / indirect			
	4000K satiné	low output CRI > 80	high output CRI > 80	dynamic white CRI > 90	low output CRI > 80	high output CRI > 80	dynamic white CRI > 90
1133 mm		1514 lm / 16,5 W	2734 lm / 28 W	2070 lm / 28 W	3704 lm / 29 W	6684 lm / 52 W	5060 lm / 51 W
1413 mm		1900 lm / 19,5 W	3429 lm / 35 W	2596 lm / 34 W	4674 lm / 36 W	8432 lm / 64 W	6383 lm / 63 W
1693 mm		2283 lm / 23 W	4119 lm / 40 W	3118 lm / 40 W	5640 lm / 43 W	10176 lm / 77 W	7703 lm / 79 W
2254 mm		3040 lm / 30 W	5485 lm / 54 W	4152 lm / 52 W	7565 lm / 57 W	13648 lm / 106 W	10332 lm / 103 W
2818 mm		3787 lm / 39 W	6831 lm / 69 W	5171 lm / 68 W	9480 lm / 72 W	17101 lm / 128 W	12945 lm / 127 W
3378 mm		4522 lm / 45 W	8157 lm / 81 W	6175 lm / 80 W	11383 lm / 86 W	20534 lm / 154 W	15544 lm / 158 W
4220 mm		5604 lm / 59 W	10109 lm / 104 W	7653 lm / 102 W	14217 lm / 108 W	25646 lm / 191 W	19414 lm / 190 W

COMPARE COVER 1414 MM, 4000 K

	direct			direct / indirect		
	low output CRI > 80	high output CRI > 80	dynamic white CRI > 90	low output CRI > 80	high output CRI > 80	dynamic white CRI > 90
satiné	1900 lm	3429 lm	2596 lm	4674 lm	8432 lm	6383 lm
jet black & light	478 lm	863 lm	653 lm	3252 lm	5866 lm	4440 lm
microprism*	2096 lm	3782 lm	2863 lm	4870 lm	8785 lm	6650 lm
BAP	2168 lm	3792 lm	2402 lm	4884 lm	8613 lm	5482 lm
asymmetric	1857 lm	3534 lm	2045 lm	4643 lm	8864 lm	5273 lm

COMPARE LIGHT COLOUR 1414 MM SATINÉ

Light Colour	Flux (lm)	Delta (%)
4000 K, CRI > 80	3429	
4000 K, CRI > 90	3384	-1,3%
3000 K, CRI > 80	3307	
3000 K, CRI > 90	3204	-3,1%

WEIGHT

	direct	direct / indirect
1133 mm	3,9 kg	4,3 kg
1413 mm	4,8 kg	5,1 kg
1693 mm	5,5 kg	6,0 kg
2254 mm	7,0 kg	7,6 kg
2818 mm	9,0 kg	9,7 kg
3378 mm	10,4 kg	11,5 kg
4220 mm	13,1 kg	14,3 kg

*Der angegebene Lichtstrom bezieht sich auf die Leuchte mit klarer mikroprismatischer Abdeckung. Die Leuchte wird mit satinierte Folie zur Erhöhung der Homogenität geliefert (direkt strahlend: -28,2%, direkt/indirekt strahlend: -11,7% Lichtstrom).

The indicated luminous flux corresponds to the luminaire with a clear microprismatic diffuser. The luminaire is delivered with a satinized foil for increased homogeneity (direct: -28,2%, direct-indirect: -11,7% luminous flux).

Le flux lumineux indiqué correspond au luminaire avec diffuseur microprismatique transparent. Le luminaire est livré avec un film satiné pour optimiser l'homogénéité (direct: -28,2%, direct-indirect: -11,7% sur le flux lumineux).

PURE 3 PROFILE SYSTEM

378



Down to UGR ≤ 16 | up to 140 lm/W | up to 6361 lm/m | IEC 62471: Blue light hazard: RG 0 | DALI switchDIM

pure 3 triflect

Hängeleuchte
Pendant luminaire
Suspension



PURE 3 TRIFLECT | PENDANT

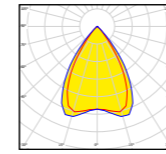

direct high-gloss gold

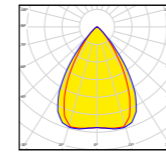

direct silver matte

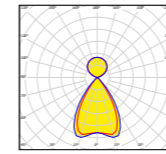

direct/indirect
Reflector gold

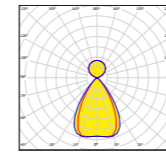

direct/indirect
Reflector silver

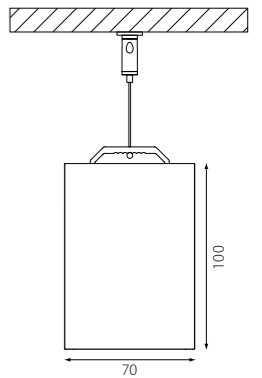
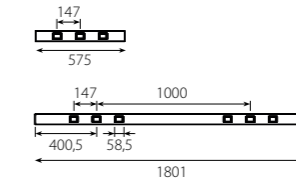

LUMINOUS FLUX (LM) / SYSTEM POWER (W), CRI > 80

	direct		direct / indirect	
	low output	high output	low output	high output
575 mm	1851 lm / 17,5W	3018 lm / 32W	2879 lm / 23W	4806 lm / 43W
1801 mm	3702 lm / 35W	6036 lm / 65W	7331 lm / 54W	12010 lm / 100W

COMPARE COVER 456 x 456 MM, 4000 K, CRI > 80, LOW OUTPUT

	direct		direct / indirect	
	low output	high output	low output	high output
4000 K silver matte	3702 lm	-	7331 lm	-
4000 K silver matte	3702 lm	-	7331 lm	-
4000 K high-gloss gold	3060 lm	-	6689 lm	-

WEIGHT

	direct	direct / indirect
575 mm	2,5 kg	2,7 kg
1801 mm	6,3 kg	6,8 kg

(based on DALI)

1 SIZE

575 mm (3 spots)	057
1801 mm (6 spots)	180

2 HOUSING COLOUR

	silver	9006
	white	9016
	black	9005
	RAL of your choice	

3 OUTPUT

	low output	L
	high output	H

4 DIRECT / INDIRECT

	direct	1
	direct / indirect	2

5 CONTROL

	non-dim	1
	DALI-dim	3

6 REFLECTOR

	silver matte*	P
	high-gloss gold*	G

* UGR-optimised, configure online

P3TH 1-2 C 3 840 4 5 6

P3TH057-9016C1840H1G pendant, 575 mm, housing white, IP20, direct, CRI > 80, 4000 K, high output, non-dim, high-gloss reflectors gold (order sample)

► Configure online on KATALOG.PLANLICHT.COM



Down to UGR ≤ 16 | up to 106 lm/W | IEC 62471: Blue light hazard: RG 0 | DALI switchDIM

NEW pure 3 shapes

Hängeleuchte
Pendant luminaire
Suspension

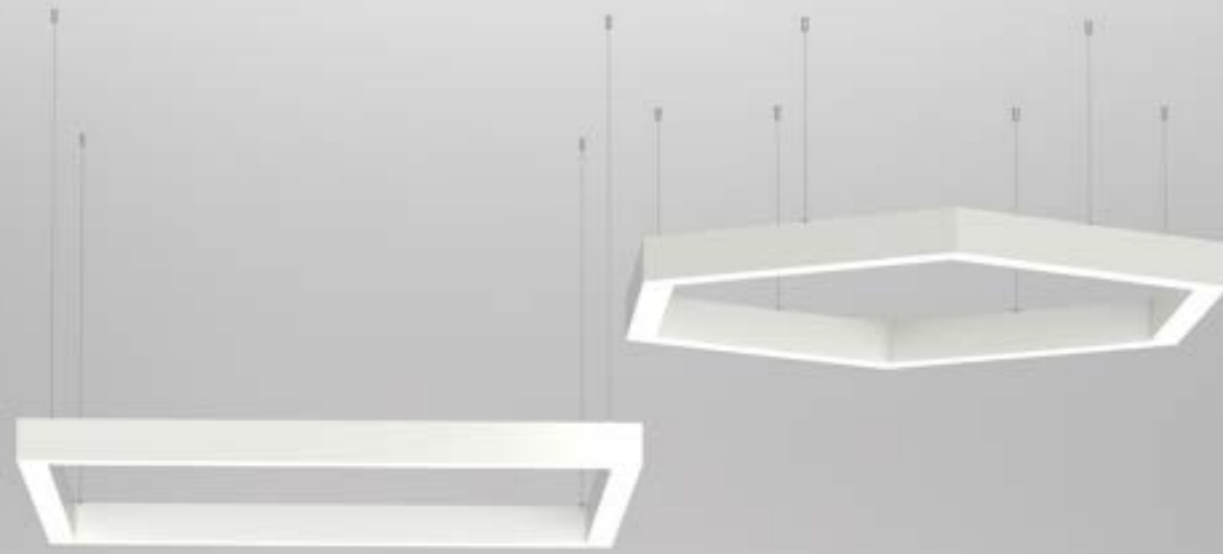

PURE 3 | PENDANT

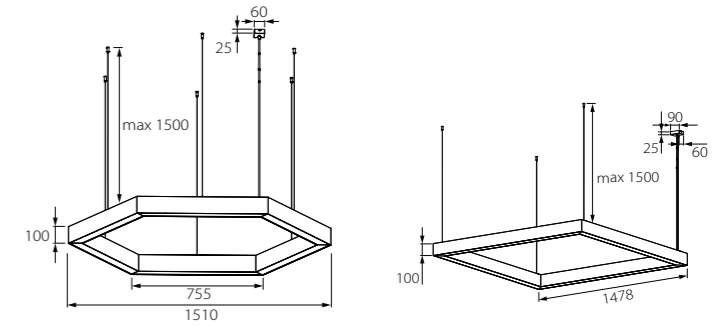
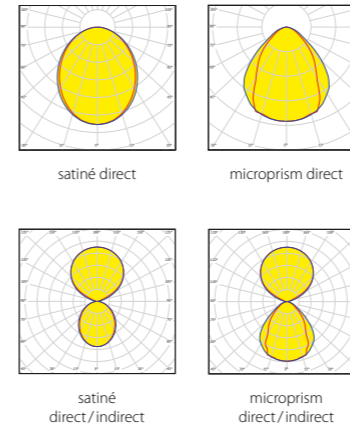

LUMINOUS FLUX (LM) / SYSTEM POWER (W)

	direct			direct/indirect			17,3 kg
	low output CRI > 80	high output CRI > 80	dynamic white CRI > 90	low output CRI > 80	high output CRI > 80	dynamic white CRI > 90	
1478 x 1478 mm	7599lm / 77W	13716lm / 137W	10822lm / 137W	19132lm / 145W	34519lm / 257W	27235lm / 263W	15,1 kg
Ø 1510 mm	5583lm / 62W	10086lm / 112W	7958lm / 118W	14196lm / 115W	25623lm / 204W	20217lm / 211W	

(based on optic S, DALI)

COMPARE COVER 1478 X 1478 MM, 4000 K, CRI > 80

	direct			direct/indirect		
	low output CRI > 80	high output CRI > 80	dynamic white CRI > 90	low output CRI > 80	high output CRI > 80	dynamic white CRI > 90
satiné	7599lm	13716lm	10822lm	19132lm	34519lm	27235lm
microprism*	8382lm	15129lm	11937lm	19915lm	35932lm	28350lm

COMPARE LIGHT COLOUR 1478 X 1478 MM, SATINÉ

Colour	Flux (lm)	Change (%)
4000 K, CRI > 80	7599lm	-1,3%
4000 K, CRI > 90	7499lm	
3000 K, CRI > 80	7328lm	-3,1%
3000 K, CRI > 90	7100lm	

*Der angegebene Lichtstrom bezieht sich auf die Leuchte mit klarer mikroprismatischer Abdeckung. Die Leuchte wird mit satiniertes Folie zur Erhöhung der Homogenität geliefert (direkt strahlend: -26,4%, direkt/indirekt strahlend: -11,1% Lichtstrom).

*The indicated luminous flux corresponds to the luminaire with a clear microprismatic diffuser. The luminaire is delivered with a satinized foil for increased homogeneity (direct: -26,4%, direct-indirect: -11,1% luminous flux).

Le flux lumineux indiqué correspond au luminaire avec diffuseur microprismatique transparent. Le luminaire est livré avec un film satiné pour optimiser l'homogénéité (direct: -26,4%, direct-indirect: -11,1% sur le flux lumineux).

1 SIZE / SHAPE

- Square (1478 x 1478 mm) **14Q**
- ⬡ Hexagon (Ø 1510 mm) **15H**

2 COLOUR

- silver **9006**
- white **9016**
- black **9005**
- RAL of your choice

3 DIRECT / INDIRECT

- ☀ direct **1**
- ☀☁ direct/indirect **2**

4 LED

- 3000 K, CRI > 80 **830**
- 4000 K, CRI > 80 **840**
- 3000 K, CRI > 90 **930**
- 4000 K, CRI > 90 **940**
- 2700 - 6500 K dynamic white, CRI > 90 **HCL**

5 OUTPUT / CONTROL

- ☑ low output non-dim **L1**
- ☑ low output DALI **L3**
- ☑ high output DALI **H3**
- ☑ dynamic white **X3**

6 OPTIC

- satiné **S**
 - microprism* **M**
- *UGR-optimised, configure online

P33H 1-2C 3 4 5 6

P33H14Q-9016C1840H3S pendant, square, 1478 x 1478 mm, white, IP20, 4000 K, CRI > 80, high output DALI, satiné (order sample)

► Configure online on KATALOG.PLANLICHT.COM

PURE 3 PROFILE SYSTEM 378

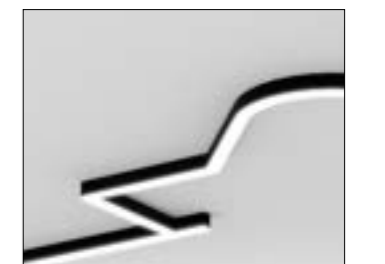

Down to UGR ≤ 16 | up to 140lm/W | IEC 62471: Blue light hazard: RG 0 | DALI switchDIM

NEW pure 3.quiet

Hängeleuchte
Pendant luminaire
Suspension

PURE 3.QUIET | PENDANT

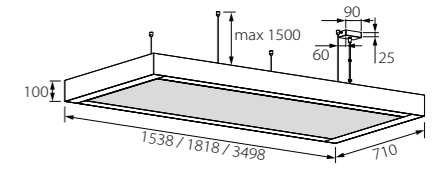
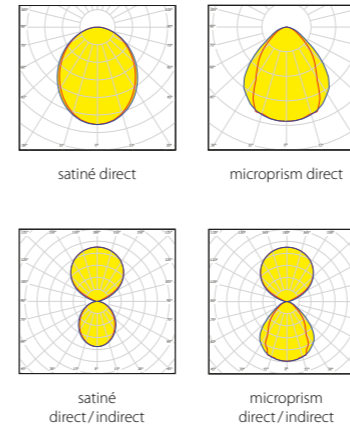

1 SIZE

1538x710 mm	15R
1818x710 mm	18R
3498x710 mm	34R

2 ACOUSTIC MODULE

- QUIET.FELT standard anthracite melange **QA**
 - QUIET.FELT standard pebble **QP**
 - QUIET.FELT standard lime **QL**
 - QUIET.FELT extra+ black * **QB**
 - QUIET.FELT extra+ fire * **QF**
 - QUIET.FELT extra+ light grey melange * **QG**
 - QUIET.FELT extra+ chocolate * **QC**
 - Organoid* Mous * **QM**
 - Organoid* Wollä * **QW**
 - Organoid* Wildspitze * **QH**
- *on request

3 HOUSING COLOUR

- silver **SI**
- white **WS**
- black **SW**
- RAL of your choice

4 DIRECT / INDIRECT

- direct **1**
- direct / indirect **2**

5 LED

- 3000K, CRI > 80 **830**
- 4000K, CRI > 80 **840**
- 3000K, CRI > 90 **930**
- 4000K, CRI > 90 **940**
- 2700 - 6500 K dynamic white, CRI > 90 **HCL**

6 OUTPUT / CONTROL

- low output non-dim **L1**
- low output DALI **L3**
- high output DALI **H3**
- dynamic white **X3**

7 OPTIC

- satiné* **S**
 - microprism* **M**
- *UGR-optimised, configure online

LUMINOUS FLUX (LM)/SYSTEM POWER (W)

	direct			direct / indirect			kg
	low output CRI > 80	high output CRI > 80	dynamic white CRI > 90	low output CRI > 80	high output CRI > 80	dynamic white CRI > 90	
1538x710 mm	3800lm / 39W	6858lm / 69W	5411 lm / 68W	9639lm / 73W	17391 lm / 129W	13721 lm / 132W	19,0 kg
1818x710 mm	4565 lm / 45W	8239lm / 82W	6501 lm / 80W	11572lm / 86W	20879lm / 155W	16474 lm / 155W	22,7 kg
3498x710 mm	9131 lm / 90W	16478lm / 163W	13001 lm / 160W	23147 lm / 173W	41758lm / 309W	32947lm / 310W	40,1 kg

COMPARE COVER 1538 x 710 MM, 4000 K, CRI > 80

	direct			direct / indirect		
4000K satiné	low output CRI > 80	high output CRI > 80	dynamic white CRI > 90	low output CRI > 80	high output CRI > 80	dynamic white CRI > 90
satiné	3800lm	6858lm	5411 lm	9639lm	17391 lm	13721 lm
microprism*	4191 lm	7564lm	5968 lm	10030lm	18097lm	14279lm

COMPARE LIGHT COLOUR 1538 x 710 MM, SATINÉ

4000 K, CRI > 80	3800lm	-1,3%
4000 K, CRI > 90	3750lm	
3000 K, CRI > 80	3665lm	
3000 K, CRI > 90	3551 lm	-3,1%

*Der angegebene Lichtstrom bezieht sich auf die Leuchte mit klarer mikroprismatischer Abdeckung. Die Leuchte wird mit satiniertes Folie zur Erhöhung der Homogenität geliefert (direkt strahlend: -26,4%, direkt/indirekt strahlend: -11,1% Lichtstrom).
The indicated luminous flux corresponds to the luminaire with a clear microprismatic diffuser. The luminaire is delivered with a satined-foil for increased homogeneity (direct: -26,4%, direct-indirect: -11,1% luminous flux).
Le flux lumineux indiqué correspond au luminaire avec diffuseur microprismatique transparent. Le luminaire est livré avec un film satiné pour optimiser l'homogénéité (direct: -26,4%, direct-indirect: -11,1% sur le flux lumineux).

ACOUSTIC ABSORBERS 2

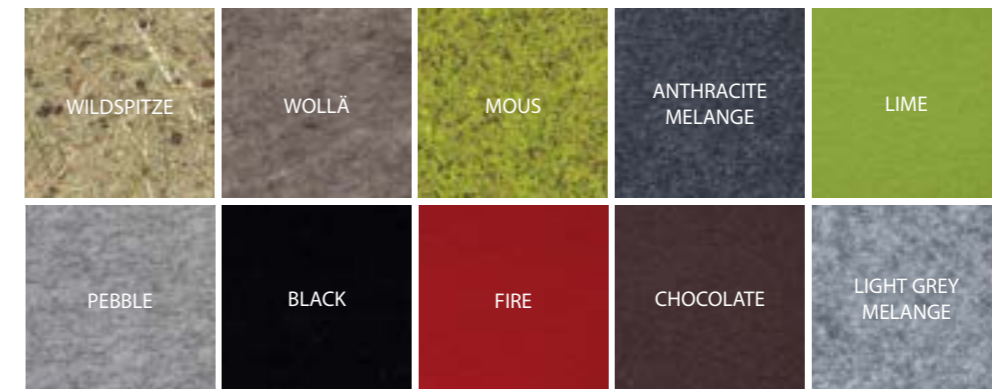

PURE 3 PROFILE SYSTEM 378

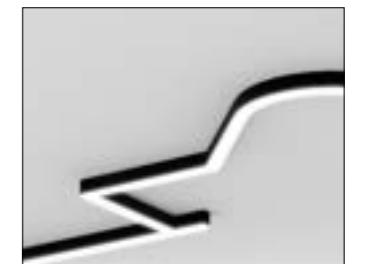

P33H 1-2-3-4-5-6-7

P33H18R-QP5WC1840H3S pendant, quiet, 1818 x 710 mm, acoustic module pebble, housing black, IP20, direct, 4000 K, CRI > 80, high output DALI, satiné (order sample)

► [Configure online on KATALOG.PLANLICHT.COM](#)



Down to UGR ≤ 16 | up to 141 lm / W | IEC 62471: Blue light hazard: RG 0 | DALI switchDIM

pure 2 IP54

Hängeleuchte
Pendant luminaire
Suspension

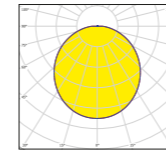
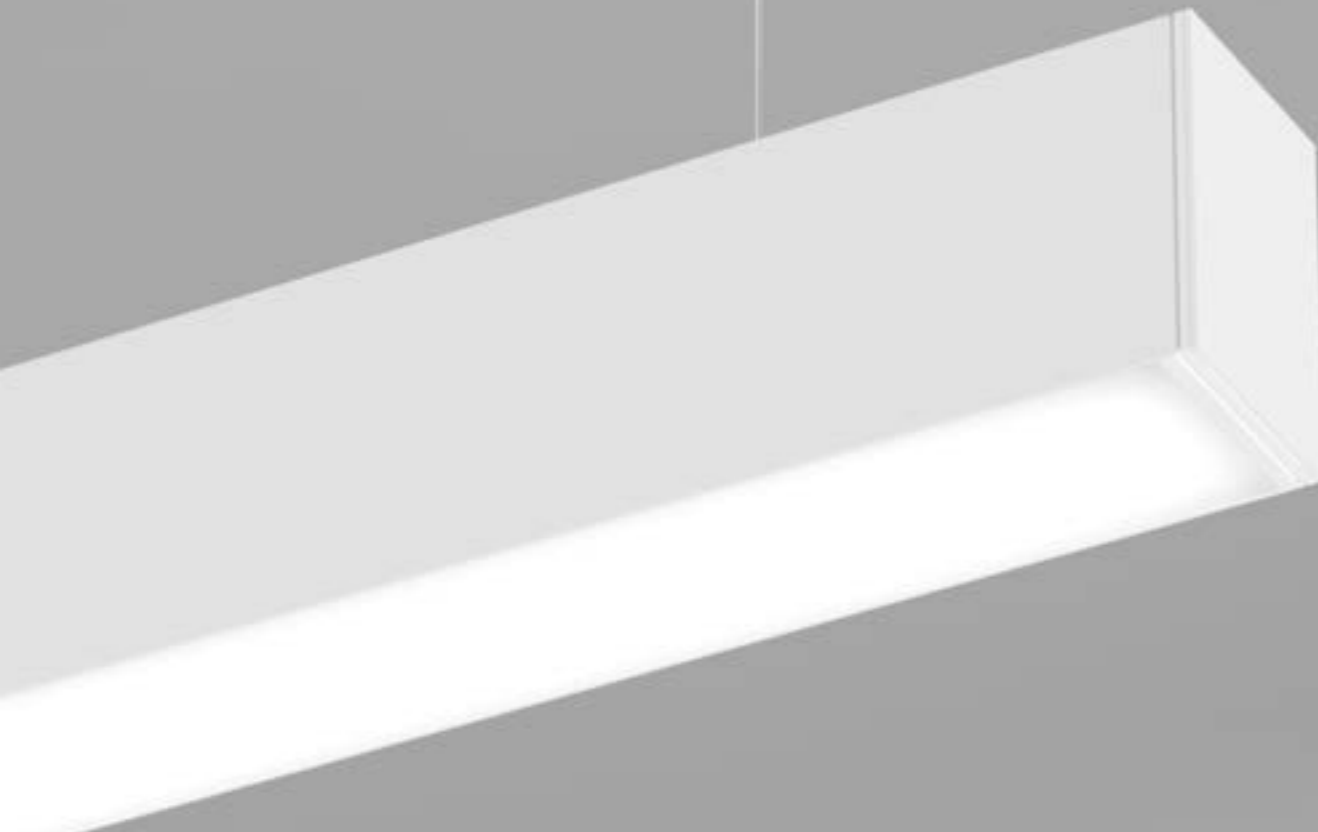

direct

PURE 2 IP54 | PENDANT

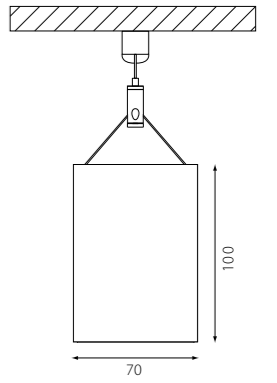

LUMINOUS FLUX (LM) / SYSTEM POWER (W)

4000K satiné	low output CRI > 80	high output CRI > 80	dynamic white CRI > 90	
1160 mm	1621 lm / 20W	2927 lm / 34W	2216 lm / 35W	4,2 kg
1440 mm	2034 lm / 24W	3672 lm / 43W	2779 lm / 43W	5,4 kg
1720 mm	2444 lm / 28W	4411 lm / 50W	3339 lm / 51W	6,2 kg
2280 mm	3255 lm / 36W	5874 lm / 66W	4446 lm / 68W	7,9 kg
2840 mm	4055 lm / 48W	7315 lm / 85W	5537 lm / 87W	10,3 kg
3400 mm	4842 lm / 56W	8734 lm / 100W	6612 lm / 102W	11,9 kg
4520 mm	6381 lm / 73W	11510 lm / 133W	8713 lm / 135W	15,3 kg

COMPARE LIGHT COLOUR 1440 MM, SATINÉ

4000 K, CRI > 80	2034 lm	-1,3%
4000 K, CRI > 90	2007 lm	
3000 K, CRI > 80	1962 lm	-3,1%
3000 K, CRI > 90	1901 lm	

1 SIZE

1160 mm	116
1440 mm	144
1720 mm	172
2280 mm	228
2840 mm	284
3400 mm	340
4520 mm	452

2 COLOUR

	silver
	white
	black
	RAL of your choice

3 LED

	3000 K, CRI > 80	830
	4000 K, CRI > 80	840
	3000 K, CRI > 90	930
	4000 K, CRI > 90	940
	2700 - 6500 K, dynamic white, CRI > 90	HCL

4 OUTPUT / CONTROL

	low output non-dim	L1
	low output DALI	L3
	high output DALI	H3
	dynamic white	X3

P58H1-2Q1345

P58H116-9016Q1840H3S pendant, 1160 mm, white, IP 54, direct, 4000 K, CRI > 80, high output DALI, satiné (order sample)

► [Configure online on KATALOG.PLANLICHT.COM](#)



up to 94 lm/W | up to 2706 lm/m | IEC 62471: Blue light hazard: RG ≤ 1 | DALI switchDIM

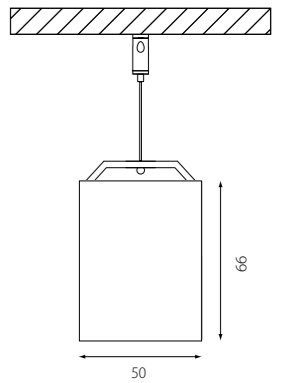
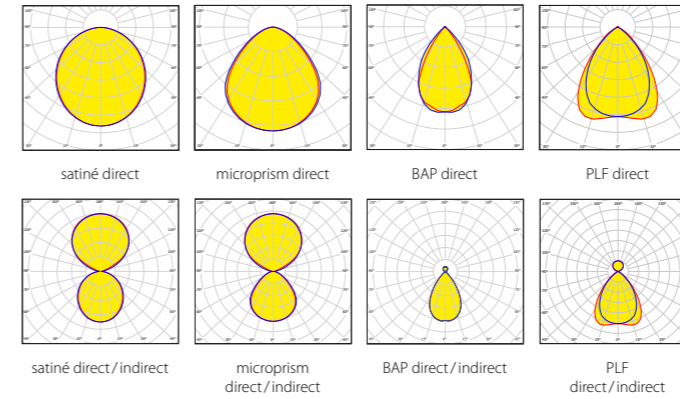

LUMINOUS FLUX (LM) / SYSTEM POWER (W)

4000K satiné	direct			direct/indirect			kg
	low output CRI > 80	high output CRI > 80	dynamic white CRI > 90	low output CRI > 80	high output CRI > 80	dynamic white CRI > 90	
1124 mm	1596 lm / 14 W	2772 lm / 23 W	2098 lm / 24 W	3521 lm / 25 W	6116 lm / 45 W	4629 lm / 44 W	3,1
1404 mm	2000 lm / 16 W	3474 lm / 30 W	2630 lm / 29 W	4439 lm / 31 W	7710 lm / 54 W	5837 lm / 55 W	3,7
1684 mm	2403 lm / 19 W	4174 lm / 35 W	3160 lm / 35 W	5355 lm / 37 W	9301 lm / 64 W	7041 lm / 65 W	4,7
2244 mm	3207 lm / 25 W	5570 lm / 46 W	4216 lm / 45 W	7186 lm / 50 W	12481 lm / 86 W	9448 lm / 89 W	6,2
2804 mm	4008 lm / 31 W	6960 lm / 55 W	5269 lm / 56 W	9014 lm / 63 W	15654 lm / 108 W	11850 lm / 110 W	7,7
3364 mm	4805 lm / 37 W	8344 lm / 66 W	6316 lm / 66 W	10839 lm / 75 W	18822 lm / 130 W	14248 lm / 132 W	9,7

(based on optic S, DALI)

COMPARE COVER 1404 MM, 4000 K, CRI > 80

	direct			direct/indirect		
	low output CRI > 80	high output CRI > 80	dynamic white CRI > 90	low output CRI > 80	high output CRI > 80	dynamic white CRI > 90
satiné	2000 lm / 16 W	3474 lm / 30 W	2630 lm / 29 W	4439 lm / 31 W	7710 lm / 54 W	5837 lm / 55 W
microprism	1580 lm / 16 W	2745 lm / 30 W	2078 lm / 29 W	4019 lm / 31 W	6981 lm / 54 W	5285 lm / 55 W
high-gloss silver	3005 lm / 23 W	5869 lm / 47 W	4656 lm / 48 W	3715 lm / 27 W	7277 lm / 56 W	5773 lm / 56 W
silver matte	2603 lm / 23 W	5083 lm / 47 W	4033 lm / 48 W	3313 lm / 27 W	6491 lm / 56 W	5150 lm / 56 W
high-gloss gold	2748 lm / 23 W	5367 lm / 47 W	4232 lm / 48 W	3458 lm / 27 W	6775 lm / 56 W	5375 lm / 56 W
high-gloss copper	2731 lm / 23 W	5334 lm / 47 W	4380 lm / 48 W	3441 lm / 27 W	6742 lm / 56 W	5349 lm / 56 W
BAP white	2827 lm / 23 W	5521 lm / 47 W	4377 lm / 23 W	3537 lm / 27 W	6929 lm / 56 W	5497 lm / 56 W
BAP black	1495 lm / 23 W	2920 lm / 47 W	2316 lm / 48 W	2205 lm / 27 W	4328 lm / 56 W	3433 lm / 56 W
glaring gold	1749 lm / 23 W	3416 lm / 47 W	2710 lm / 48 W	2459 lm / 27 W	4824 lm / 56 W	3827 lm / 56 W
capital copper	1589 lm / 23 W	3104 lm / 47 W	2463 lm / 48 W	2299 lm / 27 W	4512 lm / 56 W	3580 lm / 56 W
gunnery grey	1767 lm / 23 W	3451 lm / 47 W	2738 lm / 48 W	2477 lm / 27 W	4859 lm / 56 W	3855 lm / 56 W
high gloss black chrome	2260 lm / 23 W	4415 lm / 47 W	3502 lm / 48 W	2970 lm / 27 W	5823 lm / 56 W	4619 lm / 56 W
parabolic louvre flat	3457 lm / 29 W	5319 lm / 47 W	4220 lm / 48 W	4348 lm / 34 W	6727 lm / 56 W	5337 lm / 56 W

COMPARE LIGHT COLOUR 1414 MM, BAP SILVER MATTE

4000 K, CRI > 80	2603 lm	+4,5%
4000 K, CRI > 90	2721 lm	
3000 K, CRI > 80	2483 lm	+4,5%
3000 K, CRI > 90	2595 lm	

BAP LOUVRE COLOURS



PROFILE VIEW



1 VERSION

- quadro
- NEW** quadro.green

2 SIZE

BAP	BAP Sensor
1124 mm	112 1194 mm 119
1404 mm	140 1474 mm 147
1684 mm	168
2244 mm	224
2804 mm	280
3364 mm	336

satiné/microprism	satiné/microprism Sensor
1130 mm	113 1200 mm 120
1410 mm	141 1480 mm 148
1690 mm	169
2250 mm	225
2810 mm	281
3370 mm	337

3 COLOUR

- silver **9006**
- white **9016**
- black **9005**
- RAL of your choice

4 DIRECT / INDIRECT

- direct **1**
- direct/indirect **2**

7 OPTIC

- satiné **S** BAP white (RAL 9016)* **W**
- microprism* **M** BAP black (RAL 9005)* **N**
- BAP high-gloss silver* **B** BAP glaring gold* **D**
- BAP silver matte* **P** BAP capital copper* **R**
- BAP high-gloss gold* **G** BAP gunnery grey* **Y**
- BAP high-gloss copper* **K** BAP high gloss black chrome* **Z** **NEW**
- PLF Parabolic Louvre Flat silver semi-matte* **F** **NEW**

*UGR-optimised, configure online

5 LED

- 3000 K, CRI > 80 **830**
- 4000 K, CRI > 80 **840**
- 3000 K, CRI > 90 **930**
- 4000 K, CRI > 90 **940**
- 2700 - 6500 K, dynamic white, CRI > 90 **HCL**

6 OUTPUT / CONTROL

	no Sensor	with Sensor
low output non-dim	L1	-
low output DALI	L3	L7
high output DALI	H3	H7
dynamic white	X3	X7 (on request)

T6 1 H 2 3 C 4 4 5 6 7



quadro office special

Hängeleuchte
Pendant luminaire
Suspension

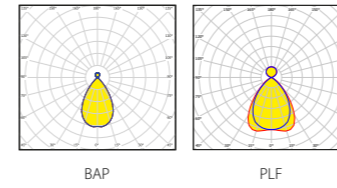
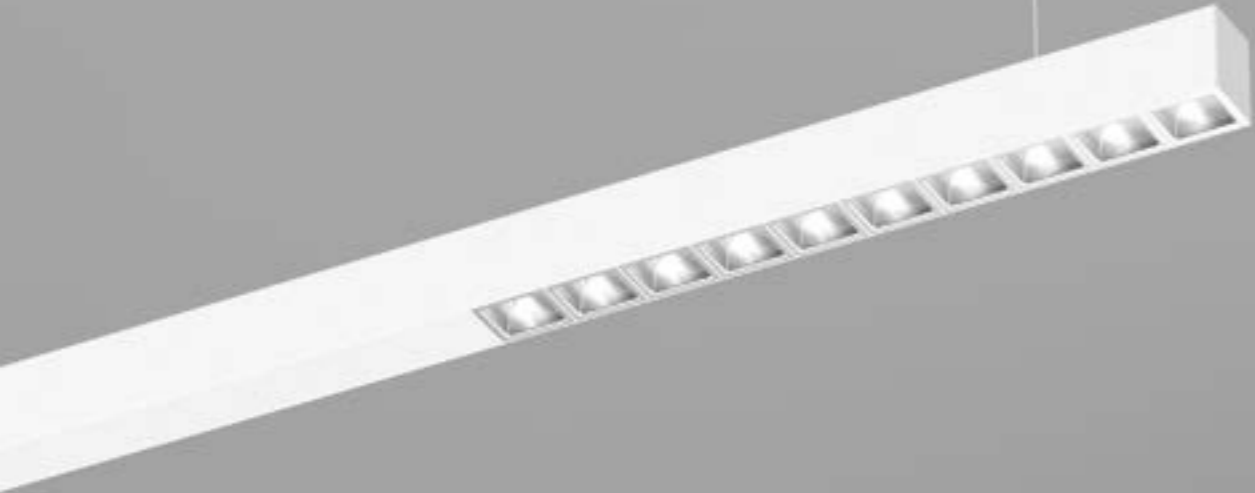

LUMINOUS FLUX (LM) / SYSTEM POWER (W)

4000 K silver matte	low output CRI > 80	high output CRI > 80	dynamic white CRI > 90	
1404 mm	2793 lm / 23W	5475 lm / 47W	4344 lm / 48W	3,3 kg
1684 mm	2936 lm / 24W	5757 lm / 49W	4568 lm / 49W	4,5 kg
3364 mm	5584 lm / 46W	10948 lm / 94W	8686 lm / 96W	9,5 kg

(based on optic S, DALI)

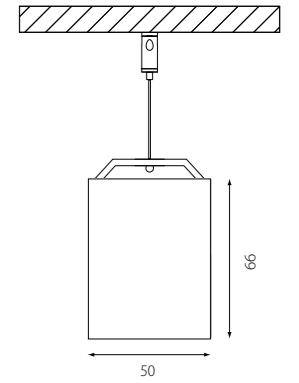

COMPARE BAP LOUVRES 1404 MM

	low output CRI > 80	high output CRI > 80	dynamic white CRI > 90
B	3115 lm	6104 lm	4843 lm
P	2793 lm	5475 lm	4344 lm
G	2909 lm	5702 lm	4524 lm
K	2895 lm	5676 lm	4503 lm
W	2972 lm	-	-
N	1906 lm	3744 lm	2971 lm
D	2110 lm	4142 lm	3286 lm
R	1982 lm	3892 lm	3088 lm
Y	2124 lm	4169 lm	3308 lm
Z	2519 lm	4941 lm	3920 lm
F	3657 lm	5664 lm	4493 lm

QUADRO OFFICE SPECIAL 1404 MM

Ideal for table size 1600x800 mm

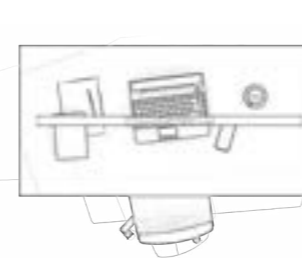
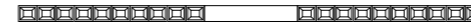

QUADRO OFFICE SPECIAL 1684 MM

Ideal for table of 1800 or 2000x1000 mm

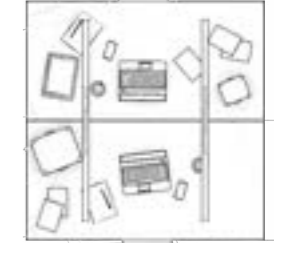
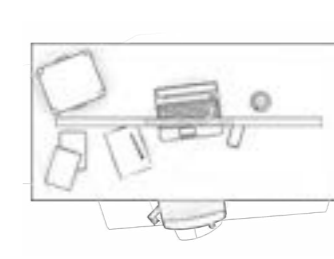

QUADRO OFFICE SPECIAL 3364 MM

Ideal for two tables of 1800 or 2000x1000 mm

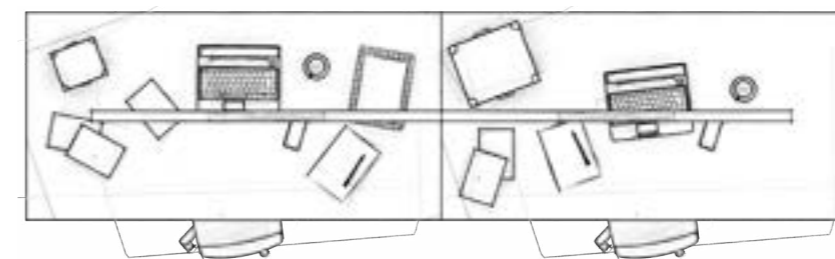

1 VERSION

quadro	S
quadro.green	G

NEW

2 SIZE

1404 mm	14X
1684 mm	16X
3364 mm	33X

3 COLOUR

	silver	9006
	white	9016
	black	9005
	RAL of your choice	

4 LED

	3000 K, CRI > 80	830
	4000 K, CRI > 80	840
	3000 K, CRI > 90	930
	4000 K, CRI > 90	940
	2700-6500 K, dynamic white, CRI > 90	HCL

5 OUTPUT/CONTROL

	no Sensor	with Sensor
	low output non-dim L1	-
	low output DALI L3	L7
	high output DALI H3	H7
	dynamic white X3	X7 (on request)

6 OPTIC

BAP high-gloss silver*	B	BAP black (RAL 9005)*	N
BAP silver matte*	P	BAP glaring gold*	D
BAP high-gloss gold*	G	BAP capital copper*	R
BAP high-gloss copper*	K	BAP gunnery grey*	Y
BAP white (RAL 9016)*	W	BAP high gloss black chrome*	Z NEW
		PLF Parabolic Louvre Flat silver semi-matte*	F NEW

* UGR-optimised, configure online

T6 1 H 2 - 3 C 2 4 5 6

T65H16X-9005C2830H3B Pendant, 1684 mm, black, IP 20, direct/indirect, 3000 K, CRI > 80, high output DALI, BAP high-gloss silver (order sample)

► Configure online on KATALOG.PLANLICHT.COM

QUADRO OFFICE SPECIAL | PENDANT



Down to UGR ≤ 16 | up to 150 lm/W | IEC 62471: Blue light hazard: RG 0 | DALI switchDIM

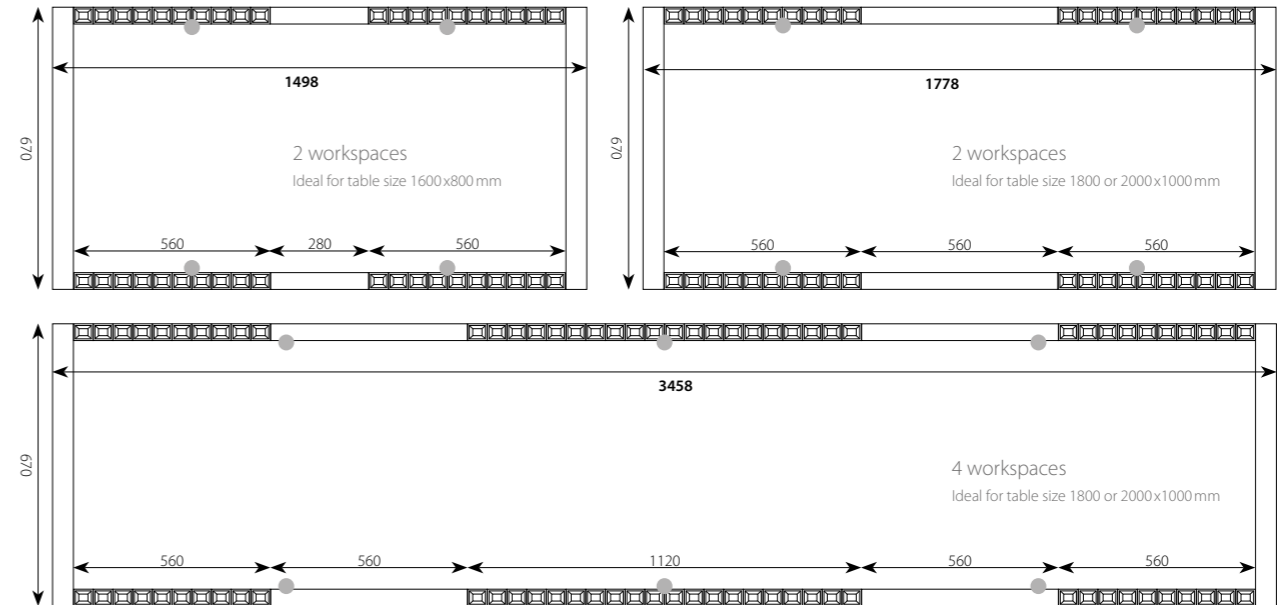
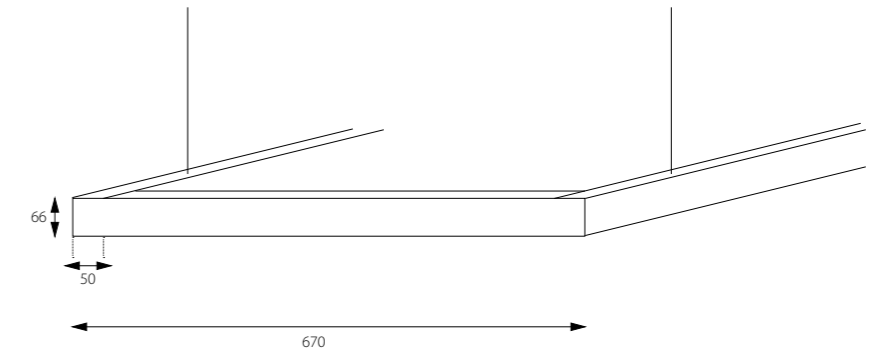
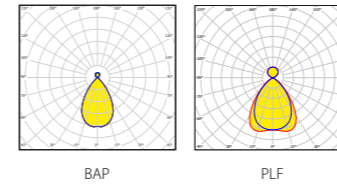

1 VERSION

quadro	5
quadro.green	G NEW

2 SIZE

1498 mm	15X
1778 mm	17X
3458 mm	34X

3 ACOUSTIC MODULE

	QUIET.FELT standard anthracite melange	QA
	QUIET.FELT standard pebble	QP
	QUIET.FELT standard lime	QL
	QUIET.FELT extra+ black *	QB
	QUIET.FELT extra+ fire *	QF
	QUIET.FELT extra+ light grey melange *	QG
	QUIET.FELT extra+ chocolate *	QC
	Organoid® Mous *	QM
	Organoid® Wollä *	QW
	Organoid® Wildspitze *	QH

*on request

4 HOUSING COLOUR

	silver	SI
	white	WS
	black	SW
	RAL of your choice	

5 LED

	3000 K, CRI > 80	830
	4000 K, CRI > 80	840
	3000 K, CRI > 90	930
	4000 K, CRI > 90	940
	2700-6500 K, dynamic white, CRI > 90	HCL

6 OUTPUT/CONTROL

	low output non-dim	L1	non Sensor
	low output DALI	L3	Sensor
	high output DALI	H3	H7
	dynamic white	X3	X7*

*on request

7 BAP LOUVRE COLOURS

BAP high-gloss silver*	B	BAP glaring gold*	D
BAP silver matte*	P	BAP capital copper*	R
BAP high-gloss gold*	G	BAP gunnery grey*	Y
BAP high-gloss copper*	K	BAP high gloss black chrome*	Z
BAP white (RAL 9016, low output)*	W	BAP high gloss black chrome*	Z NEW
BAP black (RAL 9005)*	N	PLF Parabolic Louvre Flat silver semi-matte*	F NEW

*UGR-optimised, configure online

T6 1 H 2 - 3 4 C 2 5 6 7

T65H17X-QLSWC2840H3Y pendant, 1178 mm, lime acoustic module, housing black, IP20, direct & indirect, 4000 K, CRI > 80, high output DALI, BAP gunnery grey (order sample) [Configure online on KATALOG.PLANLICHT.COM](#)

LUMINOUS FLUX (LM) / SYSTEM POWER (W)

4000K BAP silver matte	low output CRI > 80	high output CRI > 80	dynamic white CRI > 90	
1498x670 mm	5584 lm / 46W	10948 lm / 94W	8686 lm / 96W	16 kg
1778x670 mm	5869 lm / 47W	11512 lm / 98W	9133 lm / 99W	17 kg
3458x670 mm	11167 lm / 91W	21893 lm / 188W	17368 lm / 192W	31 kg

COMPARE BAP LOUVRES 1498 x 670 MM

	low output CRI > 80	high output CRI > 80	dynamic white CRI > 90
B	6228 lm	12205 lm	8693 lm
P	5584 lm	10948 lm	8686 lm
G	5816 lm	11402 lm	9046 lm
K	5789 lm	11349 lm	9004 lm
W	4247 lm	-	-
N	3812 lm	7488 lm	5940 lm
D	4219 lm	8282 lm	6570 lm
R	3963 lm	7783 lm	6174 lm
Y	4247 lm	8337 lm	6614 lm
Z	5037 lm	9879 lm	7837 lm
F	7313 lm	11325 lm	8985 lm



Down to UGR ≤ 16 | up to 145 lm/W | up to 3922 lm/m | IEC 62471: Blue light hazard: RG 0 | DALI switchDIM

NEW sinus p.thirty

Hängeleuchte
Pendant luminaire
Suspension

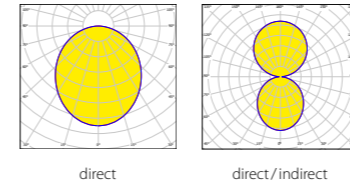

SINUS P.THIRTY | PENDANT

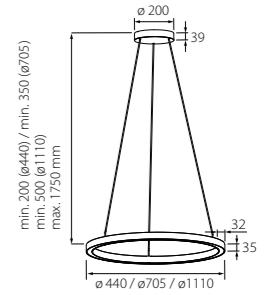

LUMINOUS FLUX (LM) / SYSTEM POWER (W)

4000K satiné	direct		direct/indirect		KG
	low output CRI > 80	high output CRI > 80	low output CRI > 80	high output CRI > 80	
ø 440 mm	1416 lm / 13,5 W	2083 lm / 21 W	3047 lm / 25 W	4471 lm / 38 W	2,0 kg
ø 705 mm	2360 lm / 21 W	3472 lm / 32 W	5079 lm / 42 W	7452 lm / 63 W	2,7 kg
ø 1110 mm	3776 lm / 34 W	5555 lm / 51 W	8126 lm / 66 W	11923 lm / 99 W	3,4 kg

(based on optic S, DALI)

COMPARE LIGHT COLOUR Ø 440 MM

2700 K, CRI > 90	1298 lm
3000 K, CRI > 90	1328 lm
4000 K, CRI > 90	1398 lm
4000 K, CRI > 80	1416 lm

1 SIZE	2 COLOUR	3 DIRECT / INDIRECT
ø 440 mm	044 silver	9006 direct 1
ø 705 mm	070 white	9016 direct/indirect 2
ø 1110 mm	111 black	9005
	RAL of your choice	

4 LED	5 OUTPUT / CONTROL
2700 K, CRI > 90	927 low output non-dim L1
3000 K, CRI > 90	930 low output DALI L3
4000 K, CRI > 90	940 high output DALI H3
4000 K, CRI > 80	840

R30Z 1-2c345s

R30Z070-9016C1927L1S pendant, rope centrally merging, ø 705 mm, black, IP 20, direct, 2700 K, CRI > 90, low output, non-dim, satiné (order sample)

► [Configure online on KATALOG.PLANLICHT.COM](#)



up to 123 lm/W | IEC 62471: Blue light hazard: RG 0 | DALI switchDIM

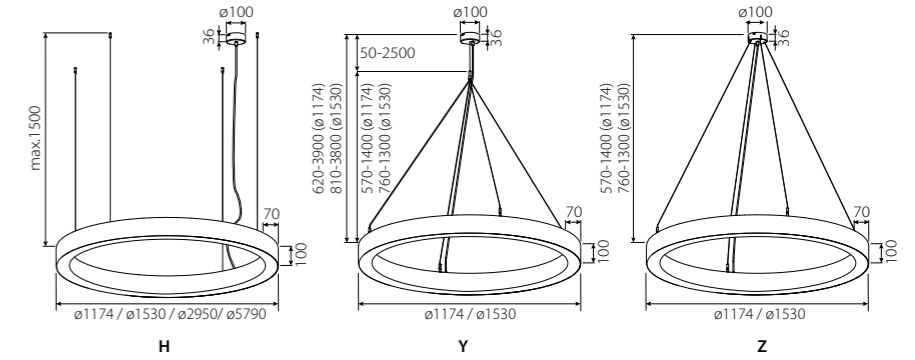
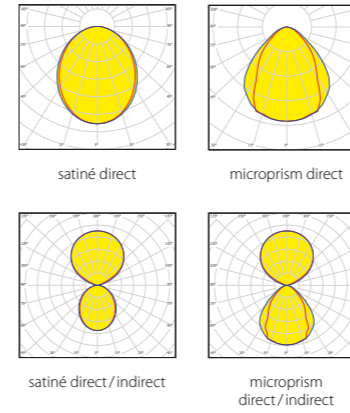

1 SUSPENSION STYLE

- Rope vertical **H**
- Rope centrally merging (1174 mm & 1530 mm) **Z**
- Rope central bundled (1174 mm & 1530 mm) **Y**

2 SIZE

- ø 1174 mm **117**
- ø 1530 mm **153**
- ø 2950 mm **295**
- ø 5790 mm **579**

3 COLOUR

- silver **9006**
- white **9016**
- black **9005**
- RAL of your choice **👉**

4 DIRECT / INDIRECT

- direct **1**
- direct/indirect **2**

5 LED

- 3000 K, CRI > 80 **830**
- 4000 K, CRI > 80 **840**
- 3000 K, CRI > 90 **930**
- 4000 K, CRI > 90 **940**
- 2700 - 6500 K dynamic white, CRI > 90 **HCL**

6 OUTPUT / CONTROL

- low output non-dim **L1**
- low output DALI **L3**
- high output DALI **H3**
- dynamic white **X3**

7 OPTIC

- satiné **S**
 - microprism* **M**
- *UGR-optimised, configure online

LUMINOUS FLUX (LM) / SYSTEM POWER (W)

	direct			direct/indirect			
	4000K satiné	low output CRI > 80	high output CRI > 80	dynamic white CRI > 90	low output CRI > 80	high output CRI > 80	
ø 1174 mm	4901 lm / 43W	8761 lm / 81W	6632 lm / 83W	10711 lm / 87W	19147 lm / 161W	14494 lm / 166W	14,8 kg
ø 1530 mm	6535 lm / 57W	11681 lm / 111W	8843 lm / 109W	14282 lm / 115W	25529 lm / 222W	19326 lm / 219W	20,2 kg
ø 2950 mm	13070 lm / 118W	23363 lm / 222W	17686 lm / 219W	28564 lm / 236W	51059 lm / 445W	38652 lm / 437W	33,7 kg
ø 5790 mm	26140 lm / 236W	46725 lm / 445W	35371 lm / 437W	57129 lm / 472W	102117 lm / 889W	77303 lm / 874W	67,4 kg

COMPARE COVER Ø 1530 MM, 4000K, CRI > 80

	low output CRI > 80	high output CRI > 80	dynamic white CRI > 90	low output CRI > 80	high output CRI > 80	dynamic white CRI > 90
satiné	6535 lm	11681 lm	8843 lm	14282 lm	25529 lm	19326 lm
microprism*	7031 lm	12567 lm	9514 lm	14778 lm	26415 lm	19997 lm

COMPARE LIGHT COLOUR Ø 1530 MM, SATINÉ, LOW OUTPUT

	low output CRI > 80	low output CRI > 90	high output CRI > 80	high output CRI > 90
4000 K, CRI > 80	6535 lm			
4000 K, CRI > 90	6448 lm	-1,3%		
3000 K, CRI > 80	6302 lm			
3000 K, CRI > 90	6106 lm		-3,1%	

Der angegebene Lichtstrom bezieht sich auf die Leuchte mit klarer mikroprismatischer Abdeckung. Die Leuchte wird mit satiniertes Folie zur Erhöhung der Homogenität geliefert (Direkt strahlend: -28,2%, direkt/indirekt strahlend: -11,7% Lichtstrom).

The indicated luminous flux corresponds to the luminaire with a clear microprismatic diffuser. The luminaire is delivered with a satinized foil for increased homogeneity (direct: -28,2%, direct-indirect: -11,7% luminous flux).

Le flux lumineux indiqué correspond au luminaire avec diffuseur microprismatique transparent. Le luminaire est livré avec un film satiné pour optimiser l'homogénéité (direct: -28,2%, direct-indirect: -11,7% sur le flux lumineux).



1 SUSPENSION STYLE

- Rope vertical **H**
- Rope centrally bundled **Z**

2 SIZE

- ø 1174 mm **117**
- ø 1530 mm **153**

3 ACOUSTIC MODULE

- QUIET.FELT standard anthracite melange **QA**
 - QUIET.FELT standard pebble **QP**
 - QUIET.FELT standard lime **QL**
 - QUIET.FELT extra+ black * **QB**
 - QUIET.FELT extra+ fire * **QF**
 - QUIET.FELT extra+ light grey melange * **QG**
 - QUIET.FELT extra+ chocolate * **QC**
 - Organoid* Mous * **QM**
 - Organoid* Wollä * **QW**
 - Organoid* Wildspitze * **QH**
- *on request

4 HOUSING COLOUR

- silver **SI**
- white **WS**
- black **SW**
- RAL of your choice

5 DIRECT / INDIRECT

- direct **1**
- direct / indirect **2**

6 LED

- 3000 K, CRI > 80 **830**
- 4000 K, CRI > 80 **840**
- 3000 K, CRI > 90 **930**
- 4000 K, CRI > 90 **940**
- 2700 - 6500 K dynamic white, CRI > 90 **HCL**

7 OUTPUT / CONTROL

- low output non-dim **L1**
- low output DALI **L3**
- high output DALI **H3**
- dynamic white **X3**

8 OPTIC

- satiné **S**
 - microprism* **M**
- *UGR-optimised, configure online

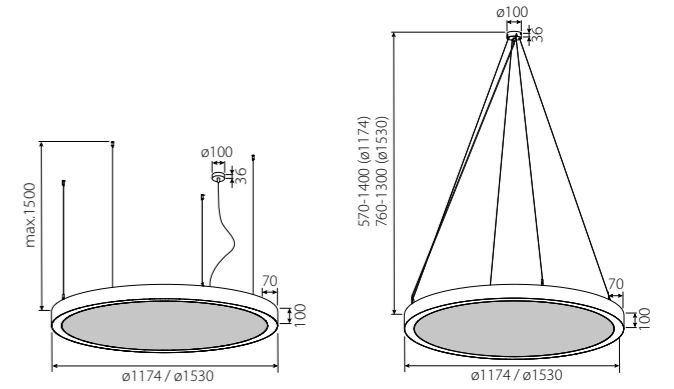
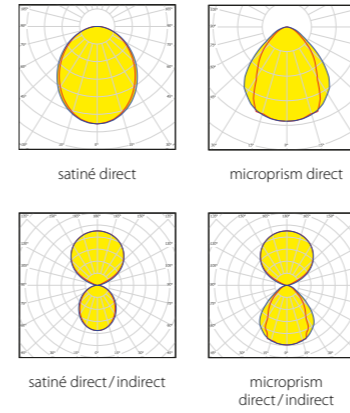

LUMINOUS FLUX (LM)/SYSTEM POWER (W)

	direct			direct / indirect			
4000K satiné	low output CRI > 80	high output CRI > 80	dynamic white CRI > 90	low output CRI > 80	high output CRI > 80	dynamic white CRI > 90	
ø 1174 mm	4901 lm / 43 W	8761 lm / 81 W	6632 lm / 83 W	10711 lm / 87 W	19147 lm / 161 W	14494 lm / 166 W	20,4 kg
ø 1530 mm	6535 lm / 57 W	11681 lm / 111 W	8843 lm / 109 W	14282 lm / 115 W	25529 lm / 222 W	19326 lm / 219 W	31,7 kg

(based on optic S, DALI)

COMPARE COVER Ø 1530 MM, 4000K, CRI > 80

	direct			direct / indirect		
	low output CRI > 80	high output CRI > 80	dynamic white CRI > 90	low output CRI > 80	high output CRI > 80	dynamic white CRI > 90
satiné	6535 lm	11681 lm	8843 lm	14282 lm	25529 lm	19326 lm
microprism*	7031 lm	12567 lm	9514 lm	14778 lm	26415 lm	19997 lm

COMPARE LIGHT COLOUR Ø 1530 MM, SATINÉ, LOW OUTPUT

4000 K, CRI > 80	6535 lm	-1,3%
4000 K, CRI > 90	6448 lm	
3000 K, CRI > 80	6302 lm	
3000 K, CRI > 90	6106 lm	-3,1%

Der angegebene Lichtstrom bezieht sich auf die Leuchte mit klarer mikroprismatischer Abdeckung. Die Leuchte wird mit satinierter Folie zur Erhöhung der Homogenität geliefert (Direkt strahlend: -28,2% , direkt/indirekt strahlend: -11,7% Lichtstrom).

The indicated luminous flux corresponds to the luminaire with a clear microprismatic diffuser. The luminaire is delivered with a satinized-foil for increased homogeneity (direct: -28,2%, direct-indirect: -11,7% luminous flux).

Le flux lumineux indiqué correspond au luminaire avec diffuseur microprismatique transparent. Le luminaire est livré avec un film satiné pour optimiser l'homogénéité (direct: -28,2 %, direct-indirect: -11,7 % sur le flux lumineux).

ACOUSTIC ABSORBERS

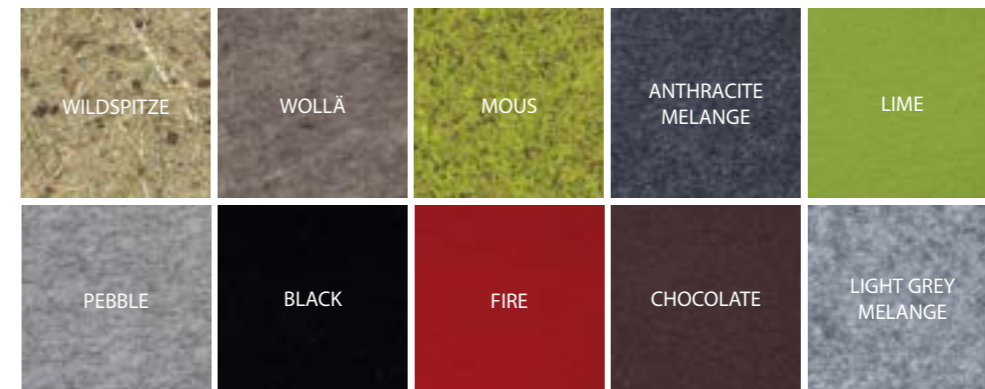

halo

Hängeleuchte
Pendant luminaire
Suspension

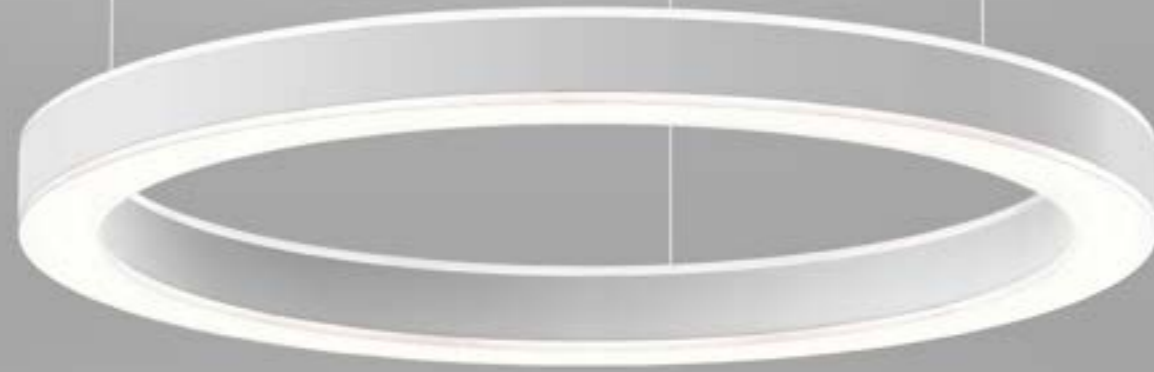

HALO | PENDANT

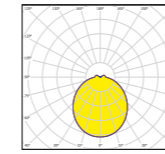

direct

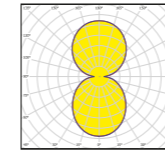

direct/indirect

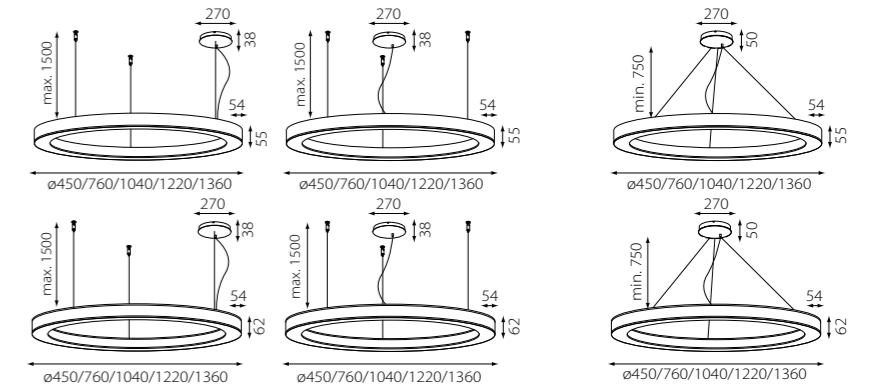

LUMINOUS FLUX (LM) / SYSTEM POWER (W)

4000 K satiné	direct			direct / indirect			kg
	low output CRI > 80	high output CRI > 80	dynamic white CRI > 90	low output CRI > 80	high output CRI > 80	dynamic white CRI > 90	
ø 450 mm	1344 lm / 13W	2252 lm / 23W	1139 lm / 15,5W	2688 lm / 26W	4504 lm / 45W	1952 lm / 26W	6,3 kg
ø 760 mm	2366 lm / 24W	3945 lm / 41W	1966 lm / 23W	4732 lm / 48W	7843 lm / 81W	3961 lm / 47W	10 kg
ø 1040 mm	3172 lm / 35W	4649 lm / 51W	2873 lm / 32W	6337 lm / 69W	9283 lm / 103W	5754 lm / 63W	14 kg
ø 1220 mm	3891 lm / 40W	6399 lm / 67W	3410 lm / 39W	7779 lm / 79W	12821 lm / 134W	6828 lm / 77W	15 kg
ø 1360 mm	4842 lm / 46W	7471 lm / 73W	3856 lm / 44W	9676 lm / 91W	14910 lm / 146W	7713 lm / 87W	18 kg

Die angegebenen Lichtstromwerte (lm) beziehen sich auf Leuchten mit einem weißen Gehäuse (RAL 9016). Unterschiedliche Gehäusefarben reduzieren diese entsprechend – silber (RAL 9006) um 21%, schwarz (RAL 9005) um 25%!

All figures of luminous flux (lm) are for fixtures with white housing (RAL 9016). Different housing colours reduce the luminous flux accordingly – silver (RAL 9006) minus 21%, black (RAL 9005) minus 25%!

Les valeurs de flux lumineux (lm) indiquées se réfèrent aux luminaires à corps blanc (RAL 9016). Différentes couleurs de corps les réduisent en conséquence – argent (RAL 9006) de 21 %, noir (RAL 9005) de 25 %!

1 SUSPENSION STYLE

- Rope vertical
- Rope central merging

H ø 450 mm
Z ø 760 mm
ø 1040 mm
ø 1220 mm
ø 1360 mm

3 COLOUR

- 045** NEW silver **9006**
- 076** white **9016**
- 104** black **9005**
- 122** RAL of your choice
- 136**

4 DIRECT / INDIRECT / INGRESS PROTECTION

- direct / IP20
- direct / indirect IP40

C1
E2

5 LED

- 3000 K, CRI > 80 **830**
- 4000 K, CRI > 80 **840**
- 3000 K, CRI > 90 **930**
- 4000 K, CRI > 90 **940**
- 2700 - 6500 K dynamic white, CRI > 90 **HCL**

6 OUTPUT / CONTROL

- low output non-dim **L1**
- low output DALI **L3**
- high output DALI **H3**
- dynamic white **X3**

R48 1 2 - 3 4 5 6 S

DESIGN: Nina Mair

R48Z076-9016C1HCLX3S pendant, rope, central merging, ø 760 mm, white, IP 20, direct, dynamic white, satiné (order sample)

► [Configure online on KATALOG.PLANLICHT.COM](#)



Down to UGR ≤ 16 | up to 106 lm/W | IEC 62471: Blue light hazard: RG 0 | DALI switchDIM

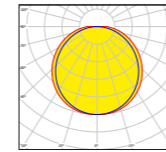

direct

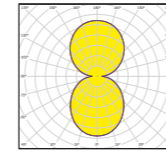

direct/indirect

Rope central merging

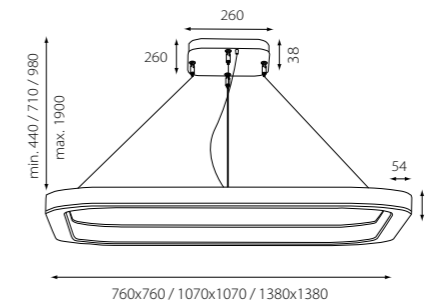

Rope vertical

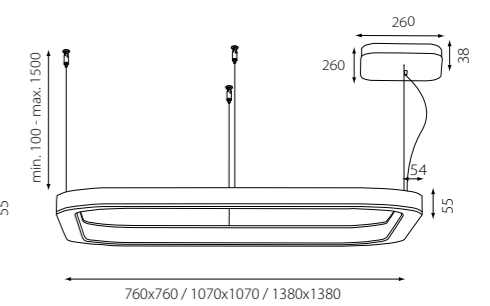

Rope central merging

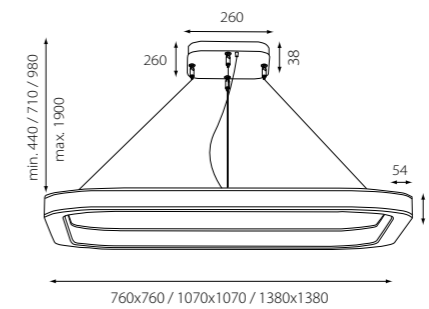

Rope vertical

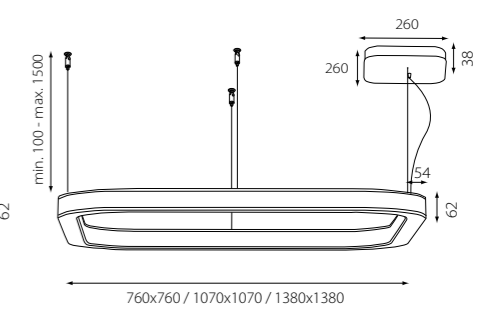

LUMINOUS FLUX (LM) / SYSTEM POWER (W)

	direct					direct/indirect				
	4000 K satiné	low output CRI > 80	high output CRI > 80	dynamic white CRI > 90		low output CRI > 80	high output CRI > 80	dynamic white CRI > 90		
760 x 760 mm	2560 lm / 26 W	4784 lm / 44 W	1704 lm / 23 W	10,7 kg	5120 lm / 88 W	9568 lm / 52 W	3408 lm / 46 W	11,5 kg		
1070 x 1070 mm	3840 lm / 39 W	7284 lm / 70 W	2616 lm / 35 W	14,2 kg	7680 lm / 77 W	14568 lm / 140 W	5232 lm / 70 W	15,0 kg		
1380 x 1380 mm	5120 lm / 53 W	9568 lm / 88 W	3488 lm / 44 W	18,7 kg	10240 lm / 105 W	19136 lm / 176 W	6976 lm / 88 W	19,5 kg		

Die angegebenen Lichtstromwerte (lm) beziehen sich auf Leuchten mit einem weißen Gehäuse (RAL 9016). Unterschiedliche Gehäusefarben reduzieren diese entsprechend – silber (RAL 9006) um 21%, schwarz (RAL 9005) um 25%!

All figures of luminous flux (lm) are for fixtures with white housing (RAL 9016). Different housing colours reduce the luminous flux accordingly – silver (RAL 9006) minus 21%, black (RAL 9005) minus 25%!

Les valeurs de flux lumineux (lm) indiquées se réfèrent aux luminaires à corps blanc (RAL 9016). Différentes couleurs de corps les réduisent en conséquence – argent (RAL 9006) de 21 %, noir (RAL 9005) de 25 % !

1 SUSPENSION STYLE

- Rope vertical
- Rope central merging

2 SIZE

H	Z
760 x 760 mm	1070 x 1070 mm
	1380 x 1380 mm

3 COLOUR

- silver **9006**
- white **9016**
- black **9005**
- RAL of your choice

4 PROTECTION | DIRECT / INDIRECT

- IP20 | direct
- IP40 | direct/indirect

5 LED

C1	E2
3000 K, CRI > 80 830	4000 K, CRI > 80 840
3000 K, CRI > 90 930	4000 K, CRI > 90 940
2700 - 6500 K dynamic white, CRI > 90 HCL	

6 OUTPUT / CONTROL

- low output non-dim **L1**
- low output DALI **L3**
- high output DALI **H3**
- dynamic white **X3**

ophelia

Hängeleuchte
Pendant luminaire
Suspension

OPHELIA | PENDANT

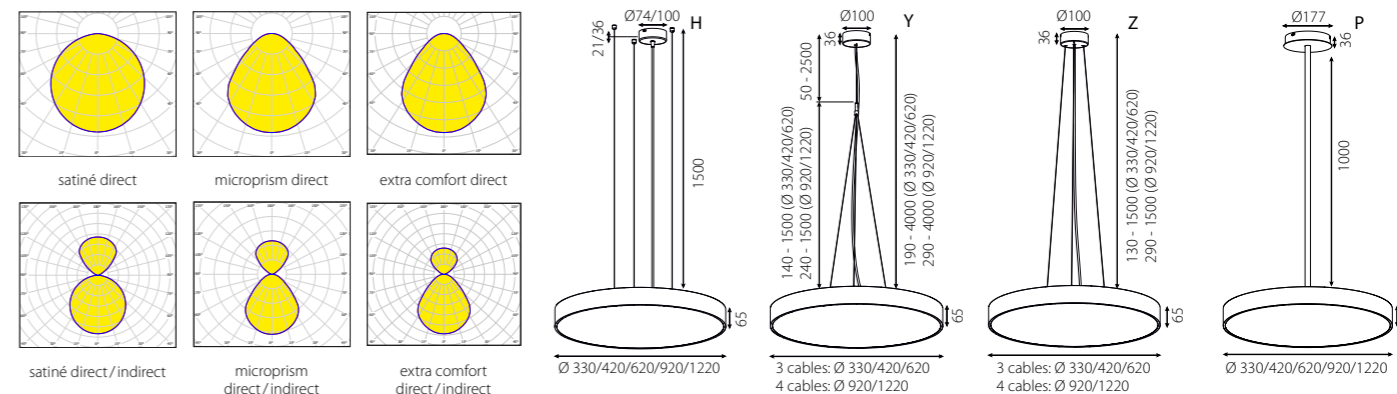

LUMINOUS FLUX (LM) / SYSTEM POWER (W)

	direct				direct / indirect			
	low output CRI > 80	high output CRI > 80	very high output CRI > 80	dynamic white CRI > 90	low output CRI > 80	high output CRI > 80	very high output CRI > 80	dynamic white CRI > 90
ø 330 mm	962lm/7,4W	2180lm/15W	2661lm/18,5W	1690lm/15W	1353lm/10W	3055lm/22W	3644lm/28W	2368lm/22W
ø 420 mm	1651lm/11,5W	3218lm/22W	3993lm/28W	2494lm/22W	2554lm/17W	5048lm/33W	6166lm/41W	3912lm/33W
ø 620 mm	3513lm/22W	6346lm/40W	7938lm/51W	4695lm/39W	5406lm/33W	9665lm/59W	11890lm/76W	7150lm/57W
ø 920 mm	7500lm/48W	14606lm/93W	18682lm/127W	11431lm/94W	10228lm/67W	19972lm/130W	25587lm/173W	15630lm/133W
ø 1220 mm	14284lm/95W	27748lm/178W	34747lm/229W	21716lm/182W	19159lm/125W	37065lm/234W	46302lm/301W	29007lm/240W

COMPARE COVER Ø 420 MM

	direct				direct / indirect			
	low output CRI > 80	high output CRI > 80	very high output CRI > 80	dynamic white CRI > 90	low output CRI > 80	high output CRI > 80	very high output CRI > 80	dynamic white CRI > 90
satiné	1651lm	3218lm	3993lm	2494lm	2554lm	5048lm	6166lm	3912lm
microprism*	1492lm	2930lm	3622lm	2271lm	2421lm	4796lm	5924lm	3717lm
extra comfort	1690lm	3319lm	4102lm	2572lm	2747lm	5437lm	6716lm	4214lm

1 SUSPENSION STYLE

- Rope vertical
- Rope centrally bundled
- Rope centrally merging
- Rod centralized

2 SIZE

Style	Size	Code
H	ø 330 mm	033
Y	ø 420 mm	042
Z	ø 620 mm	062
P	ø 920 mm	092
	ø 1220 mm	122

3 COLOUR

	silver	9006
	white	9016
	black	9005
	RAL of your choice	

4 DIRECT/INDIRECT

- direct
- direct/indirect

5 LED

	3000K, CRI > 80	830
	4000K, CRI > 80	840
	3000K, CRI > 90	930
	4000K, CRI > 90	940
	2700 - 6500K dynamic white, CRI > 90	HCL

6 OUTPUT/CONTROL

	low output non-dim	L1
	low output DALI	L3
	high output DALI	H3
	very high output DALI	V3
	dynamic white	X3

7 OPTIC

- satiné
- microprism*
- extra comfort*

* UGR-optimised, configure online

OPTIONAL ACCESSORY

	Weight (di)	Weight (di/id)	Colour	direct		direct / indirect	
				direct	direct/indirect	direct	direct / indirect
920 mm Cover Plate, Indirect Side for H/Y/Z	0,8 kg	-	white	F53-KAS-1-092-9016	-	H/Y/Z: 2,4kg/P: 3,3kg	H/Y/Z: 2,5kg/P: 3,5kg
	0,8 kg	-	silver	F53-KAS-1-092-9006	-	H/Y/Z: 3,0kg/P: 3,9kg	H/Y/Z: 3,3kg/P: 4,2kg
	0,8 kg	-	black	F53-KAS-1-092-9005	-	H/Y/Z: 4,9kg/P: 5,8kg	H/Y/Z: 5,7kg/P: 6,6kg
1220 mm Cover Plate, Indirect Side for H/Z	2,8 kg	1,8kg	white	F53-KAS-P-1-092-9016	F53-KAS-2-122-9016	H/Y/Z: 14,9kg/P: 15,7kg	H/Y/Z: 15,4kg/P: 16,2kg
	2,8 kg	1,8kg	silver	F53-KAS-P-1-092-9006	F53-KAS-2-122-9006	H/Y/Z: 22,4kg/P: 23,2kg	H/Y/Z: 23,5kg/P: 24,3kg
	2,8 kg	1,8kg	black	F53-KAS-P-1-092-9005	F53-KAS-2-122-9005		
920 mm Cover Plate, Indirect Side for P, 2 parts	0,8 kg	-	white	F53-KAS-P-1-092-9016	-		
	0,8 kg	-	silver	F53-KAS-P-1-092-9006	-		
	0,8 kg	-	black	F53-KAS-P-1-092-9005	-		
1220 mm Cover Plate, Indirect Side for P, 2 parts	2,8 kg	1,8kg	white	F53-KAS-P-1-122-9016	F53-KAS-P-2-122-9016		
	2,8 kg	1,8kg	silver	F53-KAS-P-1-122-9006	F53-KAS-P-2-122-9006		
	2,8 kg	1,8kg	black	F53-KAS-P-1-122-9005	F53-KAS-P-2-122-9005		

WEIGHT



Die angegebenen Lichtstromwerte (lm) beziehen sich auf Leuchten mit einem weißen Gehäuse (RAL 9016). Je nach Gehäusefarbe und Durchmesser reduzieren sich diese entsprechend. All figures of luminous flux (lm) are for fixtures with white housing (RAL 9016). Depending on the housing colour and diameter, the luminous flux is reduced accordingly. Les valeurs de flux lumineux (lm) indiquées se réfèrent aux luminaires à corps blanc (RAL 9016). En fonction de la couleur du corps et du diamètre, celles-ci sont réduites en conséquence.

F53 1 2 3 F 4 5 6 7

F53H042-9016F1840H3S pendant, rope vertical, ø 420 mm, white, IP 50, direct, 4000K, CRI > 80, high output DALI, satiné (order sample)

► Configure online on KATALOG.PLANLICHT.COM



Down to UGR ≤ 16 | up to 160lm/W | IEC 62471: Blue light hazard: RG 0 | DALI switchDIM



1 SUSPENSION STYLE

- Rope vertical **H**
- Rope centrally bundled **Y**
- Rope centrally merging **Z**
- Rod centralized **P**

2 SIZE

- ø330 mm **033**
- ø420 mm **042**
- ø620 mm **062**

3 COLOUR

- | | | |
|--|------------------------|-------------|
| | silver - silver | SIS1 |
| | black - silver | SWS1 |
| | capital copper - black | RRSW |
| | glaring gold - black | DDSW |
| | black - black | SWSW |
| | capital copper - white | RRWS |
| | glaring gold - white | DDWS |
| | black - white | SWSW |
| | white - white | WSWS |
| | RAL of your choice | |
- housing | Gehäuse | logement
decorative ring | Zier-Ring | anneau décoratif

4 DIRECT / INDIRECT

- direct **1**
- direct/indirect **2**

5 LED

- 3000 K, CRI > 80 **830**
- 4000 K, CRI > 80 **840**
- 3000 K, CRI > 90 **930**
- 4000 K, CRI > 90 **940**
- 2700 - 6500 K dynamic white, CRI > 90 **HCL**

6 OUTPUT / CONTROL

- low output non-dim **L1**
- low output DALI **L3**
- high output DALI **H3**
- very high output DALI **V3**
- dynamic white **X3**

7 OPTIC

- satiné **S**
 - microprism* **M**
 - extra comfort* **E** **NEW**
- * UGR-optimised, configure online

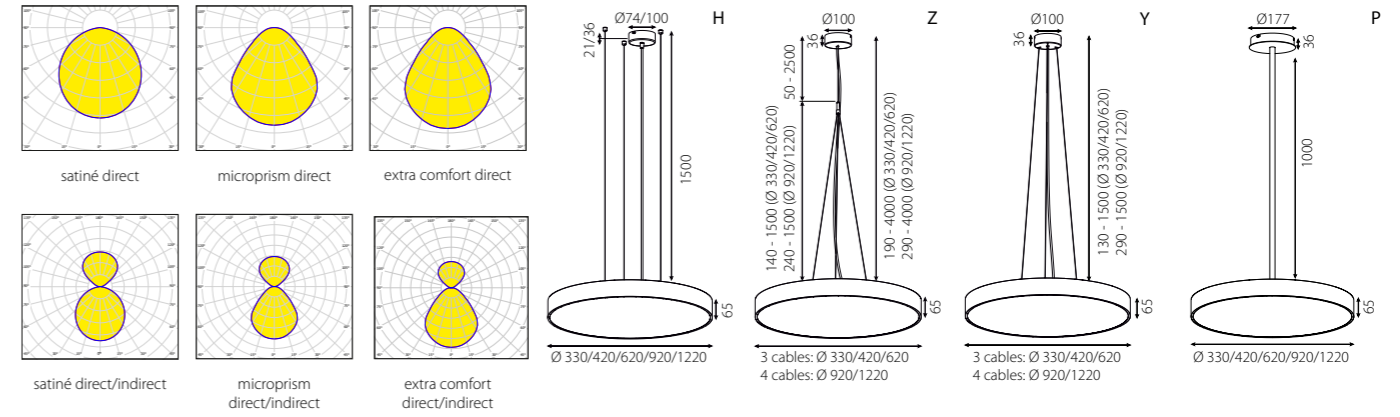

Rod standard 1 m, longer on request.

LUMINOUS FLUX (LM) / SYSTEM POWER (W)

	direct				direct / indirect			
	4000 K satiné	low output CRI > 80	high output CRI > 80	very high output CRI > 80	dynamic white CRI > 90	low output CRI > 80	high output CRI > 80	very high output CRI > 80
ø 330 mm	885 lm / 7,4W	2036 lm / 15W	2524 lm / 18,5W	1578 lm / 15W	1276 lm / 10W	2911 lm / 22W	3507 lm / 28W	2256 lm / 22W
ø 420 mm	1550 lm / 11,5W	3067 lm / 22W	3865 lm / 28W	2377 lm / 22W	2453 lm / 17W	4897 lm / 33W	6038 lm / 41W	3795 lm / 33W
ø 620 mm	3385 lm / 22W	6207 lm / 40W	7884 lm / 51W	4592 lm / 40W	5278 lm / 33W	9526 lm / 59W	11836 lm / 76W	7047 lm / 57W

COMPARE COVER Ø 420 MM

	direct				direct / indirect			
4000 K satiné	low output CRI > 80	high output CRI > 80	very high output CRI > 80	dynamic white CRI > 90	low output CRI > 80	high output CRI > 80	very high output CRI > 80	dynamic white CRI > 90
satiné	1550 lm	3067 lm	3865 lm	2377 lm	2453 lm	4897 lm	6038 lm	3795 lm
microprism	1401 lm	2793 lm	3506 lm	2164 lm	2330 lm	4659 lm	5808 lm	3610 lm
extra comfort	1708 lm	3405 lm	4274 lm	2638 lm	2637 lm	5271 lm	6576 lm	4084 lm

WEIGHT

	direct	direct / indirect
ø 330 mm	H/Y/Z: 2,7 kg / P: 3,6 kg	H/Y/Z: 2,8 kg / P: 3,8 kg
ø 420 mm	H/Y/Z: 3,4 kg / P: 4,3 kg	H/Y/Z: 3,7 kg / P: 4,6 kg
ø 620 mm	H/Y/Z: 5,5 kg / P: 6,4 kg	H/Y/Z: 6,3 kg / P: 7,2 kg

(based on optic S, DALI)

Die angegebenen Lichtstromwerte (lm) beziehen sich auf Leuchten mit einem weißen Gehäuse (RAL 9016). Je nach Gehäusefarbe und Durchmesser reduzieren sich diese entsprechend.
All figures of luminous flux (lm) are for fixtures with white housing (RAL 9016). Depending on the housing colour and diameter, the luminous flux is reduced accordingly.
Les valeurs de flux lumineux (lm) indiquées se réfèrent aux luminaires à corps blanc (RAL 9016). En fonction de la couleur du corps et du diamètre, celles-ci sont réduites en conséquence.

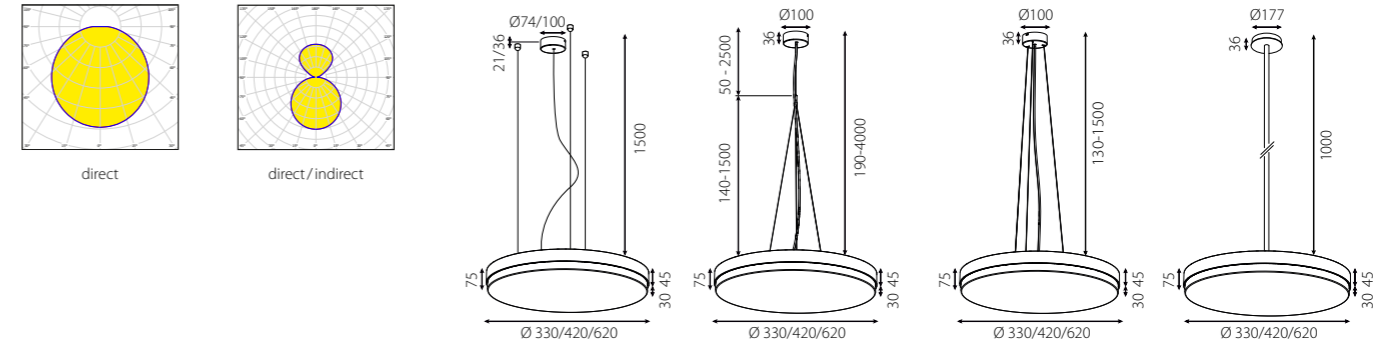

LUMINOUS FLUX (LM) / SYSTEM POWER (W)

4000 K satiné	direct			direct / indirect			H/Y/Z: 2,6 kg / P: 3,1 kg
	low output CRI > 80	high output CRI > 80	dynamic white CRI > 90	low output CRI > 80	high output CRI > 80	dynamic white CRI > 90	
ø 330 mm	1269 lm / 10,5W	2026 lm / 15W	1570 lm / 15W	-	-	-	H/Y/Z: 2,6 kg / P: 3,1 kg
ø 420 mm	1787 lm / 12,5W	3225 lm / 22W	2025 lm / 18W	2690 lm / 18W	5055 lm / 33W	3443 lm / 29W	H/Y/Z: 3,7 kg / P: 4,6 kg
ø 620 mm	3400 lm / 22,0W	6142 lm / 40W	4544 lm / 39W	5293 lm / 33W	9461 lm / 59W	6999 lm / 57W	H/Y/Z: 6,9 kg / P: 7,8 kg (based on optic S, DALI)

Die angegebenen Lichtstromwerte (lm) beziehen sich auf Leuchten mit einem weißen Gehäuse (RAL 9016). Je nach Gehäusefarbe und Durchmesser reduzieren sich diese entsprechend.
All figures of luminous flux (lm) are for fixtures with white housing (RAL 9016). Depending on the housing colour and diameter, the luminous flux is reduced accordingly.
Les valeurs de flux lumineux (lm) indiquées se réfèrent aux luminaires à corps blanc (RAL 9016). En fonction de la couleur du corps et du diamètre, celles-ci sont réduites en conséquence.

1 SUSPENSION STYLE

- Rope vertical
- Rope centrally bundled
- Rope central merging
- Rod centralized

H

ø 330 mm (direct only)

033

Y

ø 420 mm

042

Z

ø 620 mm

062

P

2 SIZE

- direct
- direct / indirect

1

3000 K, CRI > 80

830

2

4000 K, CRI > 80

840

3000 K, CRI > 90

930

4000 K, CRI > 90

940

2700 - 6500 K dynamic white, CRI > 90

HCL

3 COLOUR

- silver **9006**
- white **9016**
- black **9005**
- RAL of your choice

6 OUTPUT / CONTROL

- low output non-dim **L1**
- low output DALI **L3**
- high output DALI **H3**
- dynamic white (direct only) **X3**

F52 1 2 3 C 4 5 6 S

F52H042-9016C1840H3S pendant, rope vertical, ø 420 mm, white, IP 20, direct, 4000 K, CRI > 80, high output DALI, satiné (order sample)

► [Configure online on KATALOG.PLANLICHT.COM](#)



Down to UGR ≤ 19 | up to 160 lm/W | IEC 62471: Blue light hazard: RG 0 | DALI switchDIM

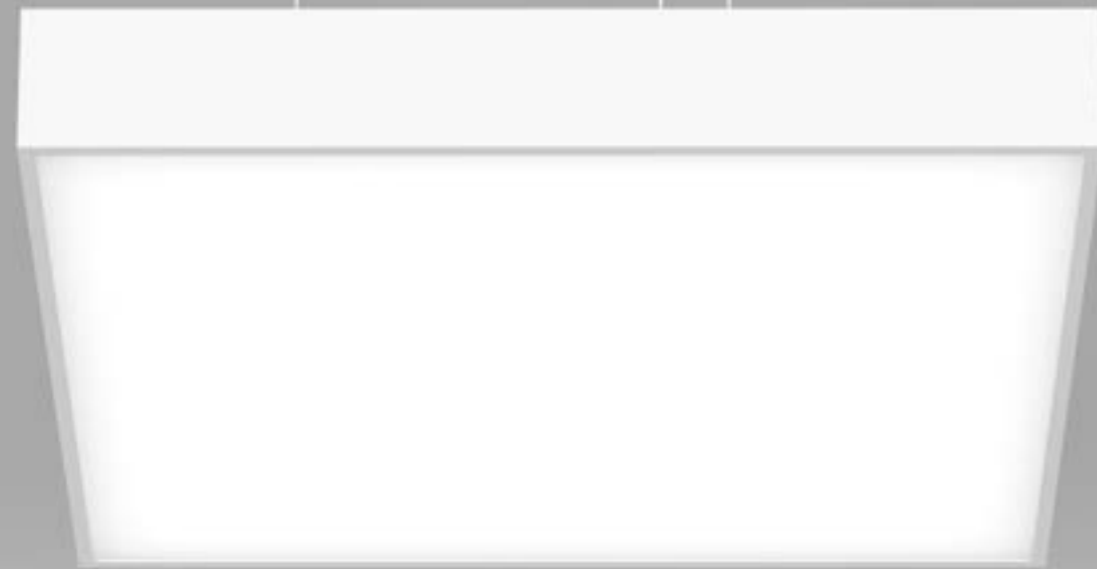

1 SUSPENSION STYLE

- Rope vertical **H**
- Rope centrally bundled **Y**
- Rope central merging **Z**
- Rod centralized **P**

2 SIZE

- 330x330 mm **03Q**
- 456x456 mm **04Q**
- 594x594 mm **05Q**
- 892x892 mm **08Q**
- 1166x1166 mm (not Y) **11Q**

3 COLOUR

- silver **9006**
- white **9016**
- black **9005**
- RAL of your choice **☛**

4 DIRECT / INDIRECT

- direct **1**
- direct/indirect **2**

5 LED

- 3000K, CRI > 80 **830**
- 4000K, CRI > 80 **840**
- 3000K, CRI > 90 **930**
- 4000K, CRI > 90 **940**
- 2700 - 6500K dynamic white, CRI > 90 **HCL**

6 OUTPUT / CONTROL

- low output non-dim **L1**
- low output DALI **L3**
- high output DALI **H3**
- dynamic white **X3**

7 OPTIC

- satiné **S**
 - microprism* **M**
 - extra comfort* **E** **NEW**
- * UGR-optimised, configure online

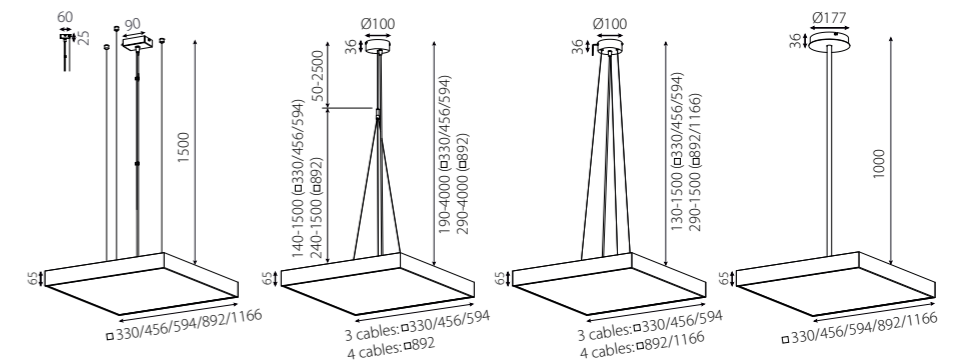
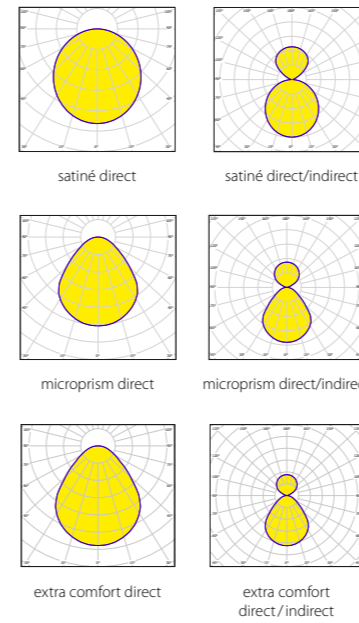

LUMINOUS FLUX (LM) / SYSTEM POWER (W)

4000 K satiné	direct					direct/indirect				
	low output CRI > 80	high output CRI > 80	dynamic white CRI > 90			low output CRI > 80	high output CRI > 80	dynamic white CRI > 90		
330 x 330 mm	1469 lm / 10,5 W	2653 lm / 18,5 W	2057 lm / 18,5 W		4,4 kg	2155 lm / 15 W	3891 lm / 27 W	3017 lm / 27 W		4,4 kg
456 x 456 mm	2882 lm / 21 W	4603 lm / 33 W	3568 lm / 33 W		4,9 kg	4297 lm / 30 W	6835 lm / 48 W	5298 lm / 48 W		5,1 kg
594 x 594 mm	4866 lm / 31 W	9137 lm / 59 W	6269 lm / 54 W		7,4 kg	7378 lm / 47 W	13833 lm / 90 W	9491 lm / 81 W		8,1 kg
892 x 892 mm	10529 lm / 67 W	19379 lm / 129 W	12619 lm / 110 W		23,0 kg	14020 lm / 93 W	28688 lm / 198 W	18104 lm / 147 W		20 kg
1166 x 1166 mm	17069 lm / 111 W	33369 lm / 208 W	25868 lm / 216 W		31,3 kg	22490 lm / 147 W	47824 lm / 312 W	35090 lm / 294 W		28,1 kg

(based on optic S, DALI)

COMPARE COVER 456 x 456 MM, 4000 K, CRI > 80

4000 K satiné	direct			direct/indirect		
	low output CRI > 80	high output CRI > 80	dynamic white CRI > 90	low output CRI > 80	high output CRI > 80	dynamic white CRI > 90
satiné	2882 lm	4603 lm	3568 lm	4297 lm	6835 lm	5298 lm
microprism	2501 lm	3995 lm	3097 lm	3916 lm	6227 lm	4827 lm
extra comfort	3115 lm	4976 lm	3857 lm	4530 lm	7208 lm	5587 lm

Die angegebenen Lichtstromwerte (lm) beziehen sich auf Leuchten mit einem weißen Gehäuse (RAL 9016). Je nach Gehäusefarbe und Durchmesser reduzieren sich diese entsprechend.

All figures of luminous flux (lm) are for fixtures with white housing (RAL 9016). Depending on the housing colour and diameter, the luminous flux is reduced accordingly.

Les valeurs de flux lumineux (lm) indiquées se réfèrent aux luminaires à corps blanc (RAL 9016). En fonction de la couleur du corps et du diamètre, celles-ci sont réduites en conséquence.

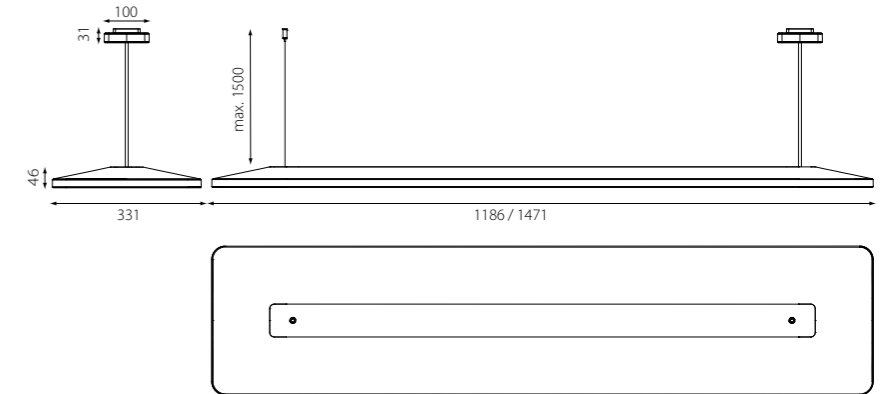
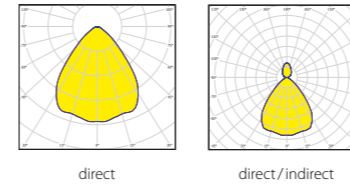
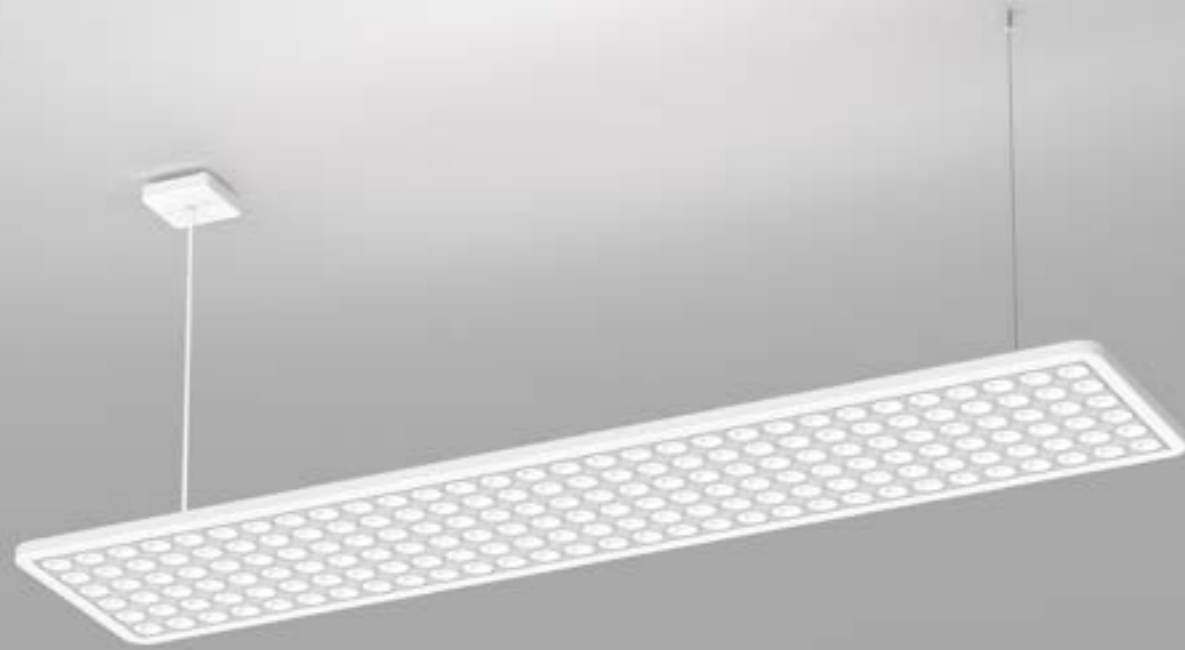

LUMINOUS FLUX (LM) / SYSTEM POWER (W)

	direct			direct/indirect			Weight (kg)
	3000 K	4000 K	dynamic white	3000 K	4000 K	dynamic white	
1186 mm	2936 lm / 30 W	3274 lm / 30 W	3493 lm / 30 W	4384 lm / 51 W	4872 lm / 51 W	5136 lm / 51 W	7,5 kg
1471 mm	3563 lm / 37 W	3974 lm / 37 W	4367 lm / 38 W	4957 lm / 56 W	4957 lm / 56 W	6123 lm / 58 W	9,0 kg

OPTIONAL ACCESSORY - DECORATIVE FRAME

Model	Length	Finish	Control
T11-ZRA-118-SW	1186 mm	high-gloss black	non dim / DALI
T11-ZRASD-118-SW	1186 mm	high-gloss black	Sensor
T11-ZRA-147-SW	1471 mm	high-gloss black	non dim / DALI
T11-ZRASD-147-SW	1471 mm	high-gloss black	Sensor

OPTIONAL ACCESSORY FOR SENSOR LUMINAIRES

54P913700359103	Extended IR Programming Tool
54P913700392403	IR Remote Control

1 SIZE

1186 mm
1471 mm

2 COLOUR

118
147

- silver
- white
- black
- RAL of your choice

3 DIRECT / INDIRECT



direct 1
direct/indirect 2

4 LED

- 3000 K, CRI > 90
- 4000 K, CRI > 90
- 2700 - 6500 K, dynamic white, CRI > 80

930
940
HCL

5 CONTROL

- non-dim 1
- DALI 3
- Sensor (direct / indirect only | not HCL) 7

T11H 1-2C34x5L

T11H118-9016C2940X3L pendant, 1186 mm, white, IP 20, direct / indirect, 4000 K, CRI > 90, general output, DALI, lense technology (order sample) > Configure online on KATALOG.PLANLICHT.COM

ENERGY SAVING TIP

One SKAI luminaire is capable to perfectly illuminate two workspaces at the same time.

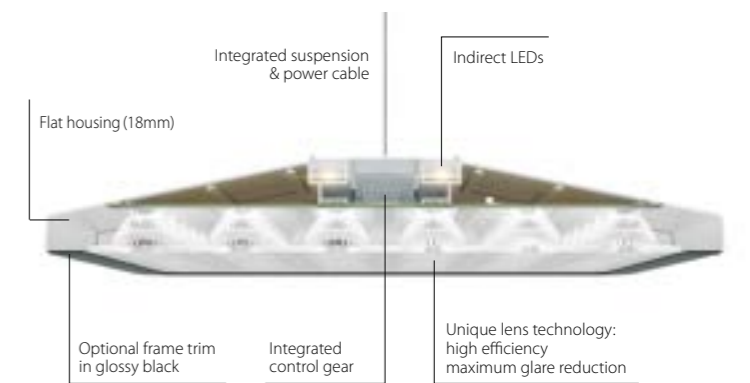
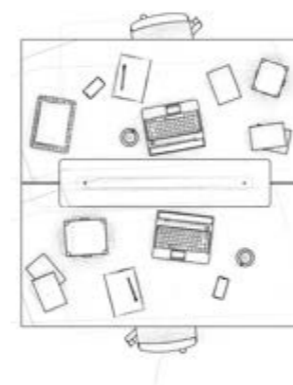

UGR ≤ 16 | up to 115 lm/W | up to 4331 lm/m | DALI switchDIM

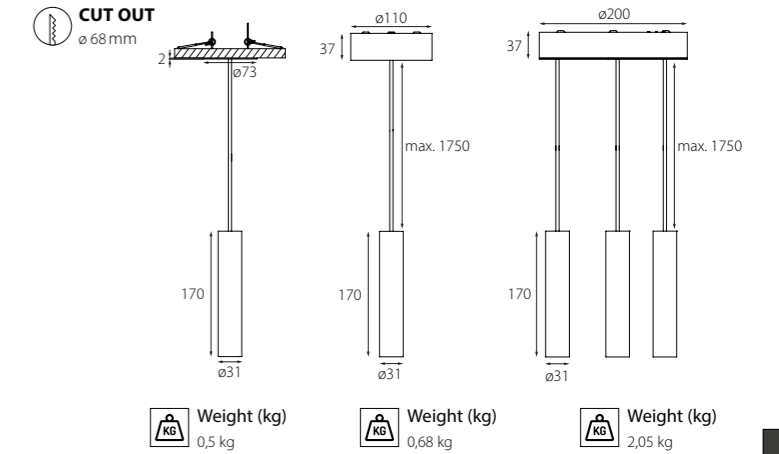
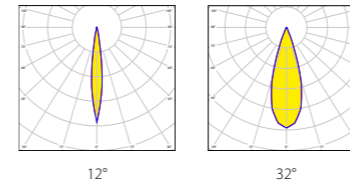
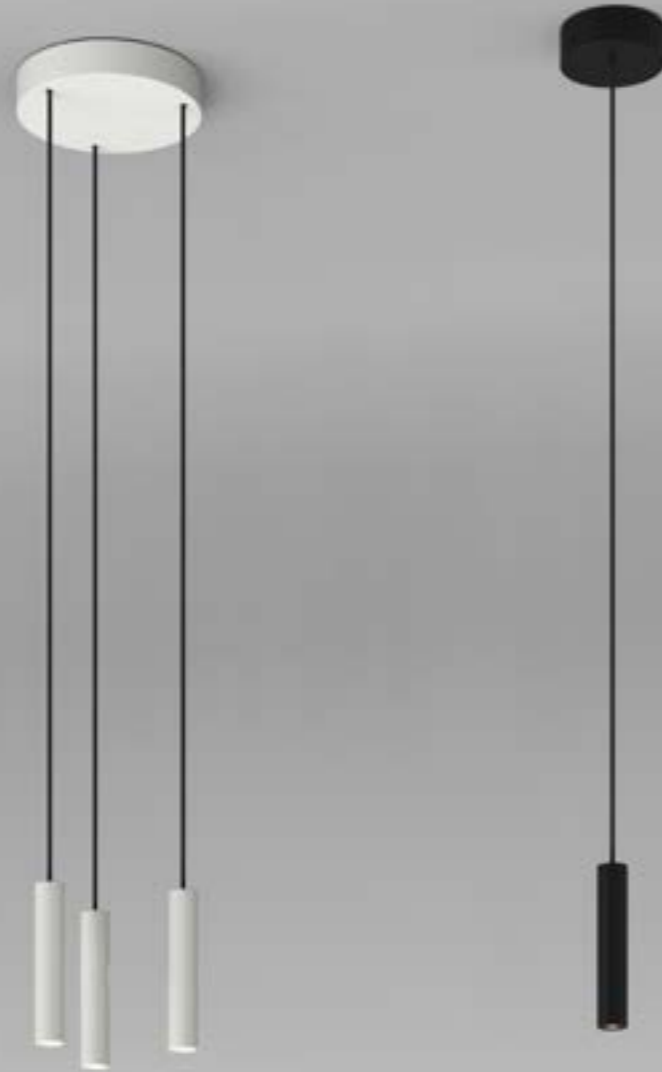

LUMINOUS FLUX (LM) / SYSTEM POWER (W)

	12°		32°	
	1 spot (7W)	3 spots (16,5W)	1 spot (7W)	3 spots (16,5W)
LF927 2700 K	183 lm	549 lm	272 lm	816 lm
LF930 3000 K	189 lm	567 lm	280 lm	840 lm
LF940 4000 K	197 lm	591 lm	292 lm	876 lm

1 CANOPY		2 LIGHTING BODY / CANOPY COLOUR		3 CONNECTION / CABLES	
Built-in canopy round, small (1 tube only)	E		lighting body	canopy	1 (M/E only) 1
Canopy round, small (1 tube only)	M	■ silver	SI	P	3 (R only) 3
Canopy round, medium (3 tube only)	R	■ white	WS	W	
		■ black	SW	N	
		■ aluminium natural transparent	AT	N	
4 LED		5 CONTROL		6 BEAM	
■ 2700 K, CRI > 90	927	■ non dim	1	■ 12°	1
■ 3000 K, CRI > 90	930	■ DALI	3	■ 32°	3
■ 4000 K, CRI > 90	940				

S10H17 1-N 2C 3 4 X 5 6

S10H17R-NSIPC3927X11 pendant, lighting body 170 mm, surface-mount housing, medium, 3 connection-cables, tube colour black, lighting body colour silver, surface-mount housing silver, IP 20, 3 equal body lengths, CRI > 90, 2700 K, DALI dim, beam angle 12° (order sample)

► [Configure online on KATALOG.PLANLICHT.COM](https://www.katalog.planlicht.com)

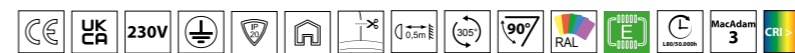

Down to UGR ≤ 16 | up to 53 lm/W | IEC 62471: Blue light hazard: RG ≤ 1 | DALI push switch DIM

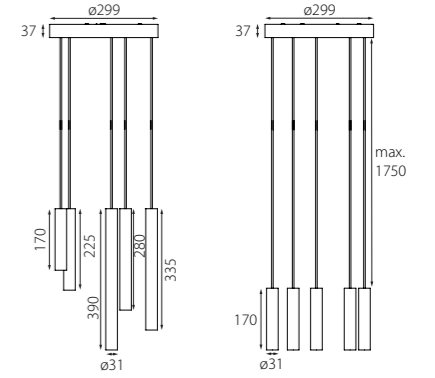
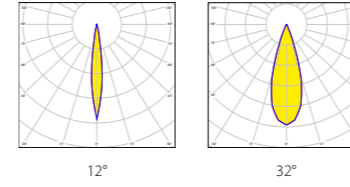

Weight (kg)
4,42 kg

Weight (kg)
3,42 kg

LUMINOUS FLUX (LM) / SYSTEM POWER (W)

	12° (26W)	32° (26W)
LF927 2700 K	915 lm	1360 lm
LF930 3000 K	945 lm	1400 lm
LF940 4000 K	985 lm	1460 lm

1 CANOPY

Canopy round, large

V

2 LIGHTING BODY / CANOPY COLOUR

lighting body	canopy
SI	P
WS	W
SW	N
AT	N

3 LIGHTING BODY/LENGTHS

5 equal sizes	5
5 various sizes	X

4 LED

2700 K, CRI > 90	927
3000 K, CRI > 90	930
4000 K, CRI > 90	940

5 CONTROL

non dim	1
DALI	3

6 BEAM

12°	1
32°	3

S10H17 1-N 2C 3 4 X 5 6

S10H17V - NATNC5930X31 pendant, round canopy, body 170 mm, surface-mount housing, 5 connection-cables, tube colour black, lighting body colour aluminium natural transparent, surface-mount housing black, IP 20, 5 equal body lengths, CRI > 90, 3000 K, DALI dim, beam angle 32° (order sample)

► [Configure online on KATALOG.PLANLICHT.COM](#)

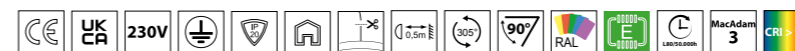

Down to UGR ≤ 16 | up to 56 lm/W | IEC 62471: Blue light hazard: RG ≤ 1 | DALI push switchDIM

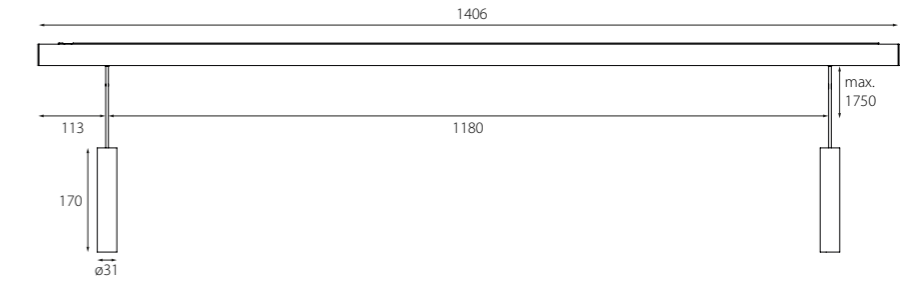
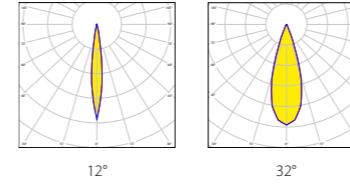

Weight (kg)
1,82 kg

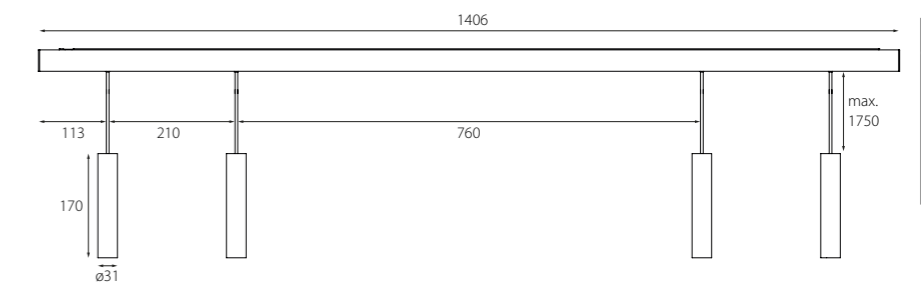

Weight (kg)
2,42 kg

LUMINOUS FLUX (LM) / SYSTEM POWER (W)

	12°		32°	
	2 spot (11,5W)	4 spots (21W)	2 spots (11,5W)	4 spots (21W)
LF927 2700K	366 lm	732 lm	544 lm	1088 lm
LF930 3000K	378 lm	756 lm	560 lm	1120 lm
LF940 4000K	394 lm	788 lm	584 lm	1168 lm

1 CANOPY **2 LIGHTING BODY / HOUSING COLOUR** **3 CONNECTION-CABLES**

Rectangular bar (2/4 tubes only)

S

2 LIGHTING BODY / HOUSING COLOUR

- silver
- white
- black
- aluminium natural transparent

- | | |
|---------------|---------|
| lighting body | housing |
| SI | P |
| WS | W |
| SW | N |
| AT | N |

- | | |
|------------|---|
| 2 (S only) | 2 |
| 4 (S only) | 4 |

4 LED **5 CONTROL** **6 BEAM**

- 2700 K, CRI > 90
- 3000 K, CRI > 90
- 4000 K, CRI > 90

- 927
- 930
- 940

- non dim
- DALI

- 1
- 3

- 12° 1
- 32° 3

S10H17 1-N 2C 3 4 X 5 6

S10H17S-NWSWC4940X31 pendant, lighting body 170 mm, surface-mount housing, 4 connection-cables, tube colour black, lighting body white, surface-mount housing black, IP 20, 4 equal lighting body lengths, CRI > 90, 4000 K, DALI dim, beam angle 32° (order sample)

► Configure online on KATALOG.PLANLICHT.COM

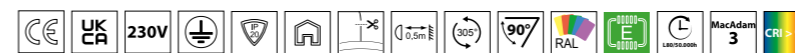

Down to UGR ≤ 16 | up to 56 lm/W | IEC 62471: Blue light hazard: RG ≤ 1 | DALI push switchDIM

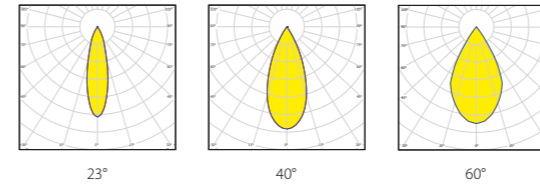

Weight (kg)
1 kg

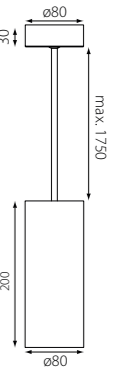

LUMINOUS FLUX (LM) / SYSTEM POWER (W)

	low output (9,3 - 10W)			medium output (11 - 12W)			high output (17 - 18,5W)			very high output (22 - 24W)		
	23°	40°	60°	23°	40°	60°	23°	40°	60°	23°	40°	60°
LF830 3000 K	1112lm	1107lm	1088lm	1322lm	1316lm	1293lm	1931lm	1917lm	1884lm	2505lm	2482lm	2440lm
LF840 4000 K	1180lm	1164lm	1144lm	1404lm	1384lm	1360lm	2050lm	2023lm	1988lm	2658lm	2624lm	2579lm
LF927 2700 K	901lm	899lm	884lm	1072lm	1069lm	1051lm	1565lm	1565lm	1538lm	2029lm	2018lm	1983lm
LF930 3000 K	944lm	952lm	936lm	1122lm	1130lm	1111lm	1629lm	1643lm	1615lm	2102lm	2120lm	2084lm
LF935 3500 K	967lm	974lm	957lm	1151lm	1159lm	1139lm	1687lm	1696lm	1667lm	2196lm	2203lm	2165lm
LF940 4000 K	976lm	989lm	972lm	1161lm	1175lm	1155lm	1696lm	1713lm	1684lm	2199lm	2219lm	2181lm
FAS	880lm	880lm	837lm	1047lm	1046lm	995lm	1531lm	1523lm	1449lm	1988lm	1969lm	1873lm
BAC	604lm	598lm	569lm	716lm	710lm	675lm	1038lm	1034lm	984lm	1333lm	1336lm	1271lm
FLE	604lm	598lm	569lm	717lm	710lm	675lm	1039lm	1031lm	981lm	1334lm	1328lm	1263lm
WUR	570lm	568lm	540lm	679lm	676lm	643lm	994lm	990lm	942lm	1293lm	1287lm	1224lm
FIS	924lm	924lm	879lm	1100lm	1098lm	1044lm	1608lm	1599lm	1521lm	2088lm	2067lm	1966lm
FRU	774lm	769lm	731lm	930lm	924lm	879lm	1403lm	1396lm	1328lm	1879lm	1875lm	1783lm

OPTIONAL ACCESSORY

Blendschutz-Wabenraster Honeycomb glare protection Filtre anti-éblouissement nid d'abeilles	S10-BLE-80
Ovalzeichnerlinse Refractor for elliptical distribution Lentille ovalisante	S10-OZL-80
Klares Schutzglas Clear protective glass Verre de protection transparent	S10-SGL-80
Weichzeichnerglas Diffuser protection glass Weichzeichnerglas Verre effet flou	S10-WGL-80

Reflektortausch werkzeuglos möglich. Passive Kühlung.
Replacement of the reflector without the use of any tools. Passive cooling.
Remplacement du réflecteur sans outil. Refroidissement passif.

NEW 1 TUBE COLOUR

- black matte (RAL 9005)
- high-gloss silver
- silver matte
- high-gloss black chrome
- high-gloss copper
- capital copper
- high-gloss gold
- glaring gold
- gunnery grey

2 HOUSING COLOUR

- SW white
- BB black
- PP RAL of your choice
- ZZ
- KK
- RR
- GG
- DD
- YY

3 LED

- WS 3000 K, CRI > 80 **830**
- SW 4000 K, CRI > 80 **840**
- ☛ 2700 K, CRI > 90 **927**
- 3000 K, CRI > 90 **930**
- 3500 K, CRI > 90 **935**
- 4000 K, CRI > 90 **940**
- Fashion (3250 K) **FAS**
- Bakery goods **BAC**
- Meat **FLE**
- Sausage products **WUR**
- Fish **FIS**
- Fruits & vegetables **FRU**

4 OUTPUT

- low output
- medium output
- high output
- very high output

5 CONTROL

- L non-dim
- M DALI
- H
- V

6 BEAM

- 23° **2**
- 40° **4**
- 60° **6**

S10H200-1-2-C1-3-4-5-6

S10H200-GGWSC1FLEM34 pendant, high-gloss gold, white housing, special LED "meat", medium output, DALI, 40° (order sample)

► [Configure online on KATALOG.PLANLICHT.COM](#)

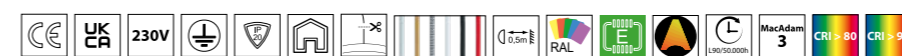

Down to UGR ≤ 16 | up to 118lm/W | IEC 62471: Blue light hazard: RG ≤ 1 | DALI touch switch DIM

WAND - LEUCHTEN

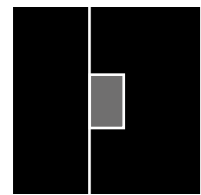

Wall luminaires
Applique murale

PROFILLEUCHTEN | PROFILE LUMINAIRES | LUMINAIRES PROFILÉS

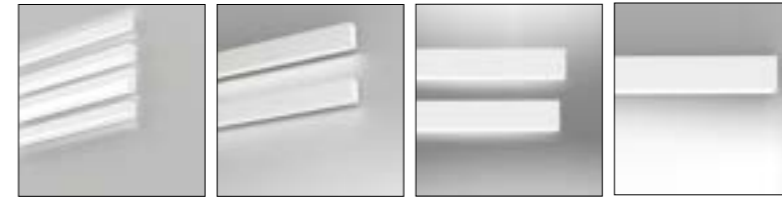

P.THIRTY
266

P.FORTY
268

PURE 3
270

PURE 2 IP 54
272

FLÄCHENLEUCHTEN | AREA LUMINAIRES | LAMPES DE SURFACE

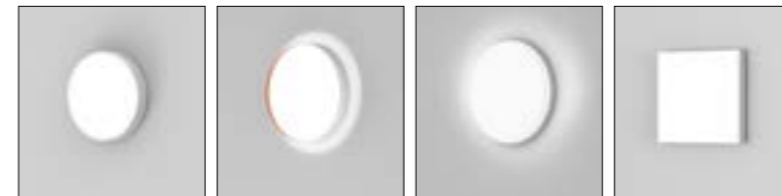

OPHELIA
274

ODELIA
276

LILIBET
278

OLMO
280

WANDLEUCHTEN | WALL LIGHTS | APPLIQUE MURALE

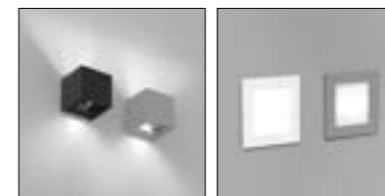

SPACECUBE
282

WALL 90
284

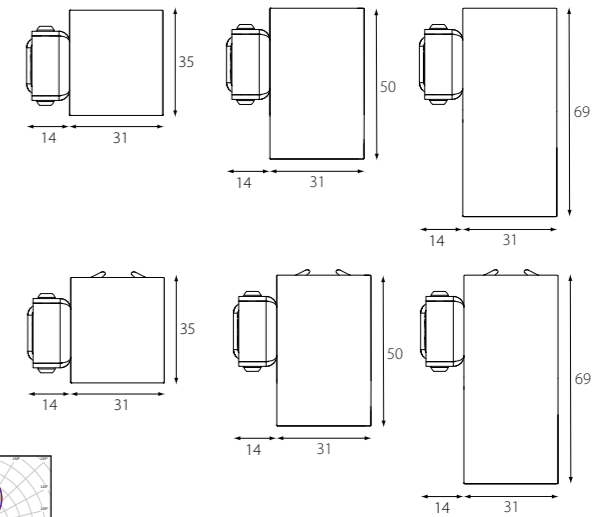
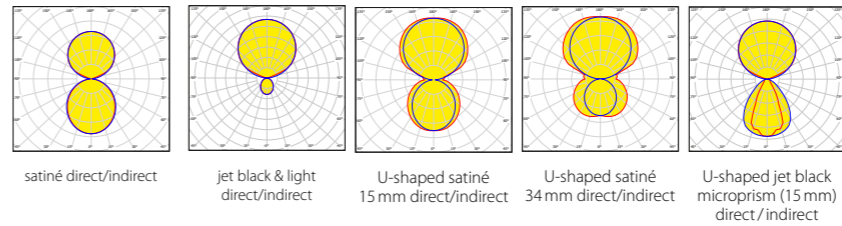
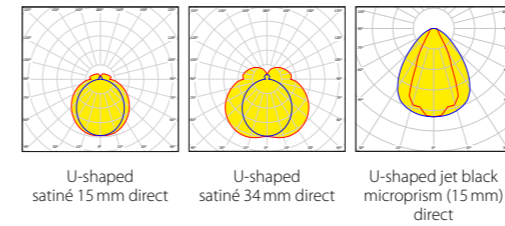
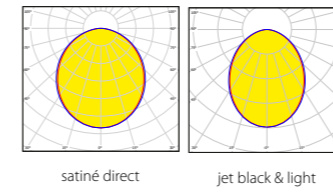
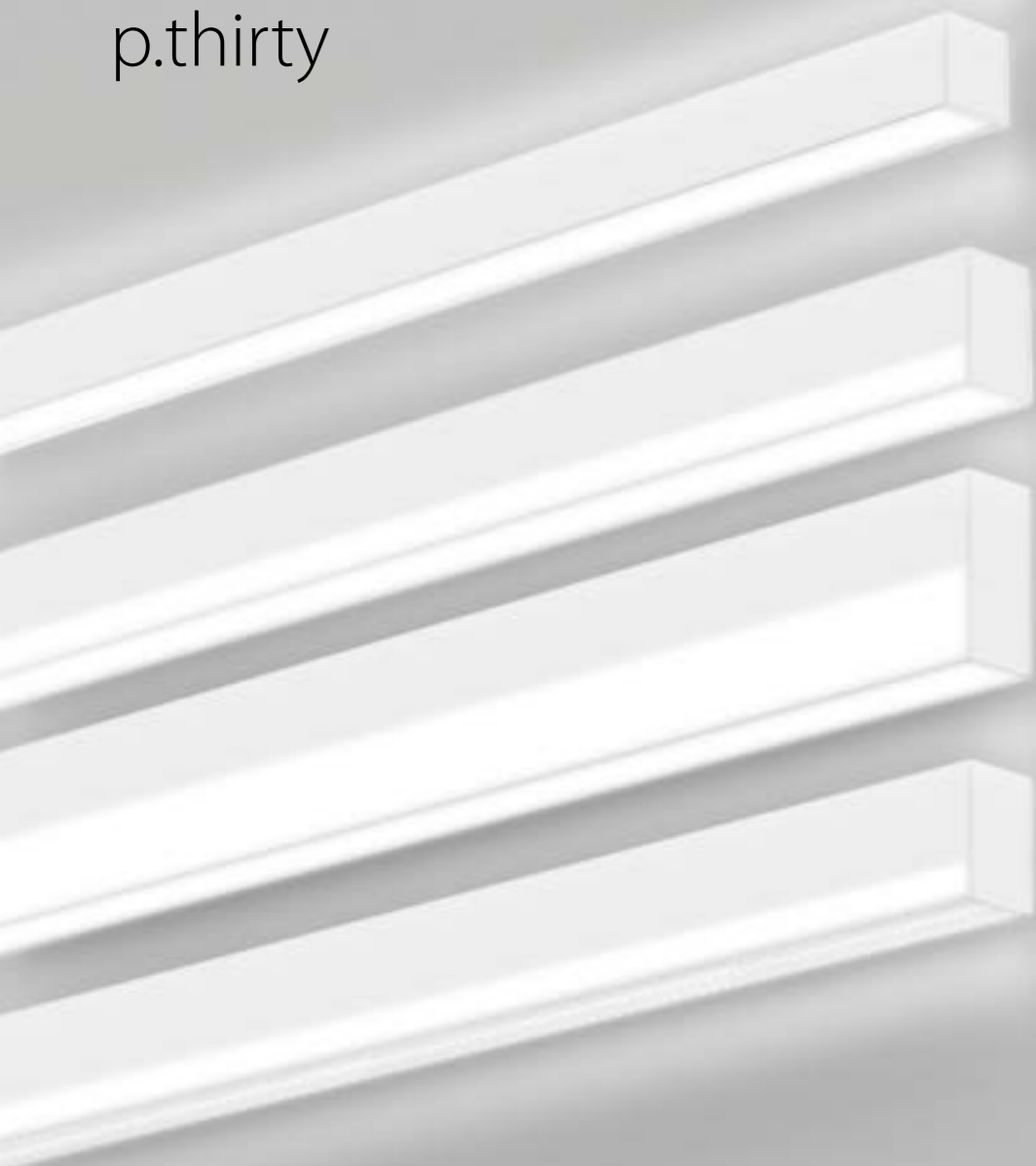

1 SIZE	2 COLOUR	3 DIRECT/INDIRECT
557 mm (only non-dim)	055 silver	9006 direct 1
827 mm	082 white	9016 direct/indirect 2
1187 mm	118 black	
1457 mm	145 RAL of your choice	
2899 mm	289	
3531 mm	353	
4341 mm	434	

4 LED	5 OUTPUT / CONTROL	6 OPTIC
NEW 2700 K, CRI > 90	927 low output non-dim L1	satiné S
3000 K, CRI > 90	930 low output DALI L3	U-shaped satiné, 15 mm U
4000 K, CRI > 90	940 high output DALI H3	U-shaped satiné, 34 mm Q
NEW 4000 K, CRI > 80	840 high output non dim (only 057) H1	jet black & light J NEW
		U-shaped jet black microprism, 15 mm* V

P30W 1-2-3-4-5-6
P30W082-9016C1930H3S wall, 827 mm, white, IP 20, CRI > 90, direct, 3000 K, high output DALI, satiné (order sample) [Configure online on KATALOG.PLANLICHT.COM](#)

LUMINOUS FLUX (LM)/SYSTEM POWER (W), CRI > 80

4000 K satiné	direct		direct/indirect		KG
	low output	high output	low output	high output	
557 mm	930lm/8W	1324lm/11,5W	1313lm/9,8W	1862lm/14W	0,6 kg
827 mm	1388lm/10,5W	1981lm/15,5W	2359lm/15,5W	3348lm/22W	0,8 kg
1187 mm	1999lm/14,5W	2855lm/21 W	3755lm/25W	5329lm/36W	1,1 kg
1457 mm	2457lm/17W	3512lm/25W	4802lm/31 W	6818lm/44W	1,3 kg
2899 mm	4895lm/34W	7008lm/50W	9992lm/63W	14200lm/91W	2,5 kg
3531 mm	5961lm/43W	8537lm/62W	12242lm/77W	17398lm/112W	3,0 kg
4341 mm	7331lm/51W	10503lm/74W	14992lm/95W	21315lm/137W	3,7 kg

(based on optic Q)

COMPARE COVER 1457 MM, 4000 K, CRI > 80

Optic	low output	high output	low output	high output
satiné	2457lm	3512lm	4802lm	6818lm
jet black & light	506lm	723lm	2851lm	4029lm
U-shaped satiné (15 mm)	2588lm	3710lm	4933lm	7015lm
U-shaped satiné (34 mm)	2724lm	3903lm	5069lm	7209lm
U-shaped jet black microprism	1419lm	723lm	3764lm	5326lm

COMPARE LIGHT COLOUR 1457 MM, SATINÉ

4000 K, CRI > 80	3512lm
2700 K, CRI > 90	2637lm
3000 K, CRI > 90	2769lm
4000 K, CRI > 90	2862lm

OPTIONAL ACCESSORY | PROTECTIVE COVER (INDIRECT)

P30-DIF-ID
LED-board cover, optional, reduces lumen output (max. 3,95 %), sold by the metre



Down to UGR ≤ 16 | up to 167 lm/W | up to 5197 lm/m | IEC 62471: Blue light hazard: RG ≤ 1 | DALI push switchDIM

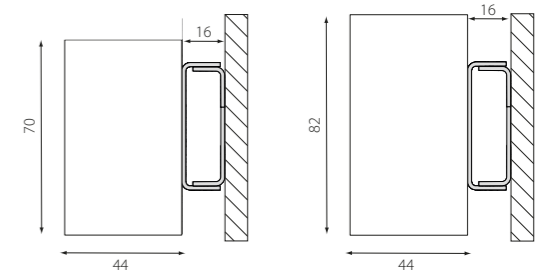
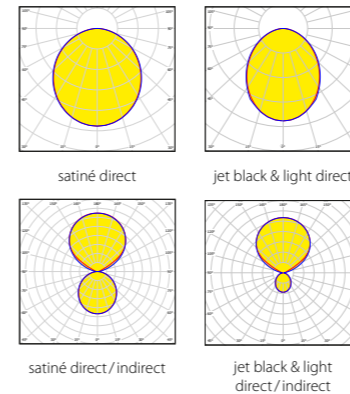

LUMINOUS FLUX (LM) / SYSTEM POWER (W)

4000K satiné	direct				direct/indirect			
	low output CRI > 80	high output CRI > 80	dynamic white CRI > 90	KG	low output CRI > 80	high output CRI > 80	dynamic white CRI > 90	KG
574 mm	769lm / 7,5 W	1339lm / 13,5W	1014lm / 14,5W	1,9kg	1845 lm / 15W	3223 lm / 24W	2440lm / 26W	2,0 kg
854 mm	1185 lm / 11,5W	2073 lm / 19,5W	1569 lm / 19,5W	2,3 kg	2799 lm / 21 W	4899 lm / 37 W	3708 lm / 37 W	2,6 kg
1134 mm	1600 lm / 15 W	2804 lm / 24 W	2123 lm / 25 W	2,7 kg	3617 lm / 27 W	6336 lm / 48 W	4797 lm / 46 W	3,2 kg
1414 mm	2014 lm / 17,5 W	3532 lm / 31 W	2674 lm / 31 W	3,3 kg	4569 lm / 33 W	8006 lm / 58 W	6061 lm / 58 W	3,7 kg
1694 mm	2427 lm / 21 W	4257 lm / 37 W	3223 lm / 36 W	3,7 kg	5519 lm / 39 W	9673 lm / 69 W	7323 lm / 72 W	4,2 kg
2254 mm	3250 lm / 27 W	5697 lm / 49 W	4313 lm / 48 W	4,6 kg	7418 lm / 52 W	12996 lm / 96 W	9838 lm / 94 W	5,2 kg
2818 mm	4069 lm / 35 W	7123 lm / 62 W	5392 lm / 62 W	6,0 kg	9312 lm / 66 W	16306 lm / 115 W	12344 lm / 115 W	7,0 kg
3378 mm	4884 lm / 41 W	8536 lm / 74 W	6462 lm / 73 W	6,9 kg	11203 lm / 78 W	19603 lm / 139 W	14840 lm / 144 W	8,1 kg
4498 mm	6502 lm / 54 W	11323 lm / 98 W	8572 lm / 95 W	8,6 kg	14972 lm / 104 W	26157 lm / 192 W	19801 lm / 188 W	10,1 kg

COMPARE COVER 1414 MM, 4000 K, CRI > 80

	direct			direct/indirect		
	low output CRI > 80	high output CRI > 80	dynamic white CRI > 90	low output CRI > 80	high output CRI > 80	dynamic white CRI > 90
satiné	2014 lm	3532 lm	2674 lm	4569 lm	8006 lm	6061 lm
jet black & light	628 lm	1101 lm	834 lm	3183 lm	5575 lm	4221 lm

COMPARE LIGHT COLOUR 1414 MM SATINÉ, LOW OUTPUT

4000 K, CRI > 80	2014 lm	-1,9%
4000 K, CRI > 90	1976 lm	
3000 K, CRI > 80	1922 lm	
3000 K, CRI > 90	1862 lm	-3,1%

1 SIZE

- 574 mm
- 854 mm
- 1134 mm
- 1414 mm
- 1694 mm
- 2254 mm
- 2818 mm
- 3378 mm
- 4498 mm

2 COLOUR

- 057
- 085
- 113
- 141
- 169
- 225
- 281
- 337
- 449

- silver
- white
- black
- RAL of your choice

3 DIRECT / INDIRECT

- 9006 direct, 70 mm Profile height (p.forty seven) 0
- 9016 direct 1
- 9005 direct/indirect 2

4 LED

- 3000 K, CRI > 80
- 4000 K, CRI > 80
- 3000 K, CRI > 90
- 4000 K, CRI > 90
- 2700 - 6500 K, dynamic white, CRI > 90

- 830
- 840
- 930
- 940
- HCL

5 OUTPUT / CONTROL

- low output non-dim
- low output DALI
- high output DALI
- dynamic white

- L1
- L3
- H3
- X3

6 OPTIC

- satiné S
- jet black & light J **NEW**

P40W 1-2-C-3-4-5-6

P40W141-9016C1840H3S wall, 1414 mm, white, IP 20, direct, 4000 K, CRI > 80, high output DALI, satiné (order sample)

Configure online on KATALOG.PLANLICHT.COM

P.FORTY PROFILE SYSTEM 364



up to 144lm/W | up to 5907lm/m | IEC 62471: Blue light hazard: RG 0 | DALI switchDIM

pure 3

Wandleuchte
Wall luminaire
Applique murale

PURE 3 | WALL

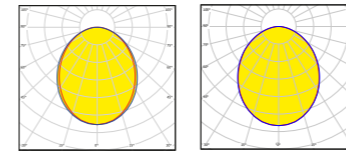

satiné direct jet black & light direct

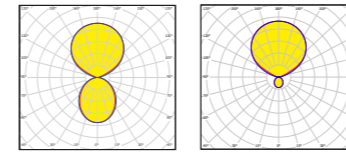

satiné direct/indirect jet black & light direct/indirect

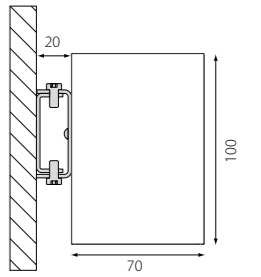

1 VERSION

pure 3	3
NEW pure 3.green	G

2 SIZE

574 mm	057
854 mm	085
1134 mm	113
1414 mm	141
1694 mm	169
2254 mm	225
2818 mm	281
3378 mm	337
4222 mm	422

3 COLOUR

	silver	9006
	white	9016
	black	9005
	RAL of your choice	

4 DIRECT / INDIRECT

	direct	1
	direct/indirect	2

5 LED

	3000 K, CRI > 80	830
	4000 K, CRI > 80	840
	3000 K, CRI > 90	930
	4000 K, CRI > 90	940
	2700 - 6500 K, dynamic white, CRI > 90	HCL

6 OUTPUT / CONTROL

	low output non-dim	L1
	low output DALI	L3
	high output DALI	H3
	dynamic white	X3

7 OPTIC

	satiné	S
	jet black & light	J NEW

LUMINOUS FLUX (LM) / SYSTEM POWER (W)

	direct			direct/indirect			kg
	low output CRI > 80	high output CRI > 80	dynamic white CRI > 90	low output CRI > 80	high output CRI > 80	dynamic white CRI > 90	
574 mm	735 lm / 8,2W	1328 lm / 15W	1005 lm / 16W	1903 lm / 16,5W	3435 lm / 28W	2600 lm / 29W	2,8 kg
854 mm	1126 lm / 12,5W	2033 lm / 21W	1539 lm / 22W	2878 lm / 23W	5193 lm / 41W	3931 lm / 40W	3,6 kg
1134 mm	1514 lm / 16,5W	2734 lm / 28W	2070 lm / 28W	3704 lm / 29W	6684 lm / 52W	5060 lm / 51W	4,5 kg
1414 mm	1900 lm / 19,5W	3429 lm / 35W	2596 lm / 34W	4674 lm / 36W	8432 lm / 64W	6383 lm / 63W	5,3 kg
1694 mm	2283 lm / 23W	4119 lm / 40W	3118 lm / 40W	5640 lm / 43W	10176 lm / 77W	7703 lm / 79W	6,1 kg
2254 mm	3040 lm / 30W	5485 lm / 54W	4152 lm / 52W	7565 lm / 57W	13648 lm / 106W	10332 lm / 103W	7,8 kg
2818 mm	3787 lm / 39W	6831 lm / 69W	5171 lm / 68W	9480 lm / 72W	17101 lm / 128W	12945 lm / 127W	10,1 kg
3378 mm	4522 lm / 45W	8157 lm / 81W	6175 lm / 80W	11383 lm / 86W	20534 lm / 154W	15544 lm / 158W	11,9 kg
4222 mm	5604 lm / 59W	10109 lm / 104W	7653 lm / 102W	14217 lm / 108W	25646 lm / 191W	19414 lm / 190W	14,7 kg

COMPARE COVER 1414 MM, 4000 K, CRI > 80

	direct			direct/indirect		
	low output CRI > 80	high output CRI > 80	dynamic white CRI > 90	low output CRI > 80	high output CRI > 80	dynamic white CRI > 90
satiné	1900 lm	3429 lm	2596 lm	4674 lm	8432 lm	6383 lm
jet black & light	478 lm	863 lm	653 lm	3252 lm	5866 lm	4440 lm

COMPARE LIGHT COLOUR 1414 MM SATINÉ

Light Colour	4000 K, CRI > 80	3000 K, CRI > 80
4000 K, CRI > 80	3429 lm	-1,3 %
4000 K, CRI > 90	3384 lm	
3000 K, CRI > 80	3307 lm	
3000 K, CRI > 90	3204 lm	-3,1 %

PURE 3 PROFILE SYSTEM 378



P3 1 W 2 - 3 E 4 5 6 7

P33W057-9016E1840H3S wall, 574 mm, white, IP40, direct, 4000 K, CRI > 80, high output DALI, satiné (order sample)

► [Configure online on KATALOG.PLANLICHT.COM](https://www.katalog.planlicht.com)



Down to UGR ≤ 19 | up to 135 lm/W | up to 6214 lm/m | IEC 62471: Blue light hazard: RG 0 | DALI switchDIM

pure 2 IP54

Wandleuchte
Wall luminaire
Applique murale

PURE 2 IP54 | WALL

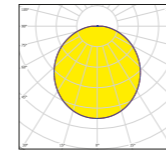

satiné direct

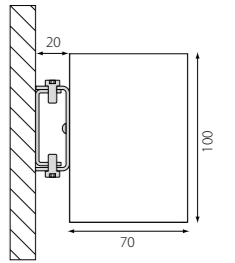

LUMINOUS FLUX (LM) / SYSTEM POWER (W)

4000K satiné	low output CRI > 80	high output CRI > 80	dynamic white CRI > 90	
600 mm	787 lm / 10W	1422 lm / 17,5W	1076 lm / 20W	2,6 kg
880 mm	1205 lm / 15,5W	2177 lm / 26W	1648 lm / 27W	3,4 kg
1160 mm	1621 lm / 20W	2927 lm / 34W	2216 lm / 35W	4,4 kg
1440 mm	2034 lm / 24W	3672 lm / 43W	2779 lm / 43W	5,4 kg
1720 mm	2444 lm / 28W	4411 lm / 50W	3339 lm / 51W	6,2 kg

COMPARE LIGHT COLOUR 1440 MM SATINÉ

4000 K, CRI > 80	2034 lm	-1,3%
4000 K, CRI > 90	2007 lm	
3000 K, CRI > 80	1962 lm	-3,1%
3000 K, CRI > 90	1901 lm	

1 SIZE

600 mm	060
880 mm	088
1160 mm	116
1440 mm	144
1720 mm	172

2 COLOUR

	silver	9006
	white	9016
	black	9005
	RAL of your choice	

3 LED

	3000 K, CRI > 80	830
	4000 K, CRI > 80	840
	3000 K, CRI > 90	930
	4000 K, CRI > 90	940
	2700 - 6500 K, dynamic white, CRI > 90	HCL

4 OUTPUT / CONTROL

	low output non-dim	L1
	low output DALI	L3
	high output DALI	H3
	dynamic white	X3

P58W **1-2-Q1-3-4-5**

P58W060-9016Q1840H3S wall, 600 mm, white, IP 54, direct, CRI > 80 4000K, high output DALI, satiné (order sample)

► [Configure online on KATALOG.PLANLICHT.COM](#)



up to 88 lm/W | up to 2626 lm/m | IEC 62471: Blue light hazard: RG 0 | DALI switchDIM

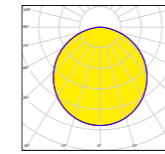

satiné

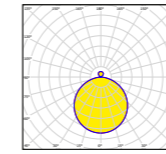

satiné direct/indirect

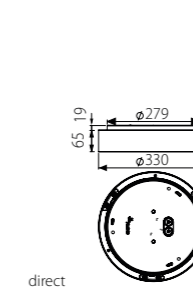

direct

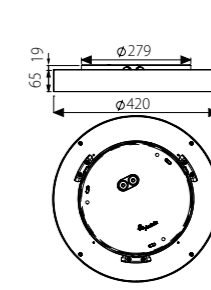

direct/indirect

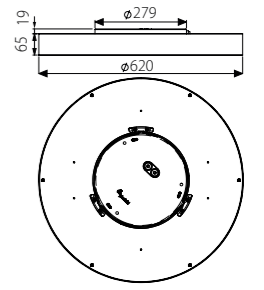

LUMINOUS FLUX (LM) / SYSTEM POWER (W)

	direct				direct/indirect			
	low output CRI > 80	high output CRI > 80	very high output CRI > 80	dynamic white CRI > 90	low output CRI > 80	high output CRI > 80	very high output CRI > 80	dynamic white CRI > 90
ø 330 mm	962 lm / 7,4 W	2180 lm / 15 W	2661 lm / 18,5 W	1690 lm / 15 W	-	-	-	-
ø 420 mm	1651 lm / 11,5 W	3218 lm / 22 W	3993 lm / 28 W	2494 lm / 22 W	1788 lm / 11,5 W	3484 lm / 22 W	4273 lm / 28 W	2700 lm / 22 W
ø 620 mm	3513 lm / 22 W	6346 lm / 40 W	7938 lm / 51 W	4695 lm / 39 W	3715 lm / 22 W	6641 lm / 40 W	8374 lm / 51 W	4913 lm / 39 W

WEIGHT	direct	direct/indirect
	ø 330 mm	2,0 kg
ø 420 mm	2,6 kg	2,7 kg
ø 620 mm	4,5 kg	4,9 kg

Die angegebenen Lichtstromwerte (lm) beziehen sich auf Leuchten mit einem weißen Gehäuse (RAL 9016). Je nach Gehäusefarbe und Durchmesser reduzieren sich diese entsprechend.
All figures of luminous flux (lm) are for fixtures with white housing (RAL 9016). Depending on the housing colour and diameter, the luminous flux is reduced accordingly.
Les valeurs de flux lumineux (lm) indiquées se réfèrent aux luminaires à corps blanc (RAL 9016). En fonction de la couleur du corps et du diamètre, celles-ci sont réduites en conséquence.

1 SIZE

- ø 330 mm (direct only)
- ø 420 mm
- ø 620 mm

- 033**
- 042**
- 062**

2 COLOUR

- silver
- white
- black
- RAL of your choice

- 9006**
- 9016**
- 9005**

3 INGRESS PROTECTION

- IP50
- IP54 (only direct)

- F**
- Q**

4 DIRECT/INDIRECT

- direct
- direct/indirect

- 1**
- 2**

5 LED

- 3000 K, CRI > 80
- 3000 K, CRI > 80
- 4000 K, CRI > 90
- 4000 K, CRI > 90
- 2700 - 6500 K dynamic white, CRI > 90

- 830**
- 840**
- 930**
- 940**
- HCL**

6 OUTPUT/CONTROL

- low output non-dim
- low output DALI
- high output DALI
- very high output DALI
- dynamic white

- L1**
- L3**
- H3**
- V3**
- X3**

F53W **1-2-3-4-5-6-S**

F53W042-9016F1930V3S wall, ø420 mm, white, IP50, direct, 4000 K, CRI > 90, very high output DALI, satiné (order sample)

► [Configure online on KATALOG.PLANLICHT.COM](#)



up to 169 lm/W | IEC 62471: Blue light hazard: RG 0 | DALI switchDIM



1 SIZE

- ø 330 mm (direct only)
- ø 420 mm
- ø 620 mm

2 COLOUR

033		silver - silver	SISI
042		black - silver	SWSI
062		capital copper - black	RRSW
		glaring gold - black	DDSW
		black - black	SWSW
		capital copper - white	RRWS
		glaring gold - white	DDWS
		black - white	SWWS
		white - white	WSWS
		RAL of your choice	

Gehäuse | housing | logement
Zier-Ring | decorative ring | anneau décoratif

3 DIRECT / INDIRECT

	direct	1
	direct/indirect	2

4 LED

- 3000 K, CRI > 80
- 4000 K, CRI > 80
- 3000 K, CRI > 90
- 4000 K, CRI > 90
- 2700 - 6500 K dynamic white, CRI > 90

5 OUTPUT / CONTROL

830		low output non-dim	L1
840		low output DALI	L3
930		high output DALI	H3
940		very high output DALI	V3
HCL		dynamic white	X3

F54W 1-2-F3-4-5-S

F54W042 - SISIF1830V3S wall, ø 420 mm, silver decorative ring, silver housing, IP50, direct, 3000 K, CRI > 80, very high output DALI, satiné (order sample)

► [Configure online on KATALOG.PLANLICHT.COM](#)

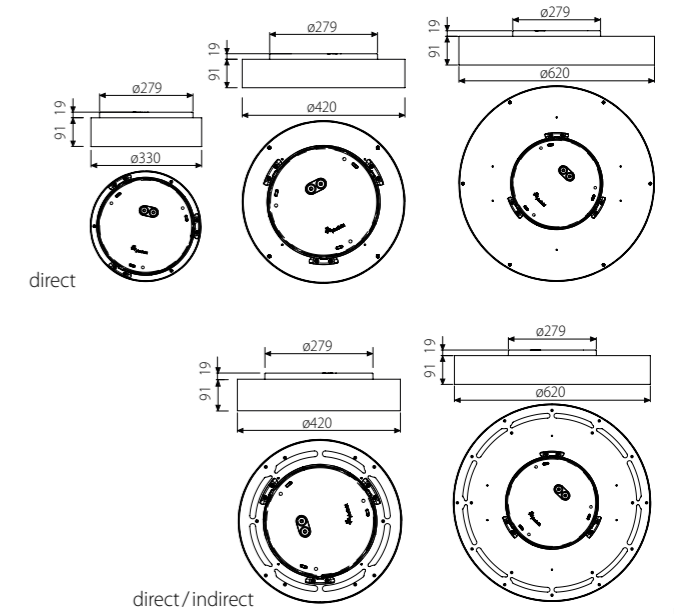
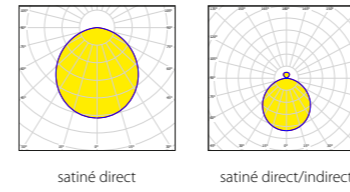

LUMINOUS FLUX (LM) / SYSTEM POWER (W)

	direct				direct / indirect			
	low output CRI > 80	high output CRI > 80	very high output CRI > 80	dynamic white CRI > 90	low output CRI > 80	high output CRI > 80	very high output CRI > 80	dynamic white CRI > 90
ø 330 mm	885 lm / 7,4 W	2036 lm / 15 W	2524 lm / 18,5 W	1578 lm / 15 W	-	-	-	-
ø 420 mm	1550 lm / 11,5 W	3067 lm / 22 W	3865 lm / 28 W	2377 lm / 22 W	1687 lm / 11,5 W	3333 lm / 22 W	4145 lm / 28 W	2583 lm / 22 W
ø 620 mm	3385 lm / 22 W	6207 lm / 40 W	7884 lm / 51 W	4592 lm / 39 W	3587 lm / 22 W	6502 lm / 40 W	8320 lm / 51 W	4810 lm / 40 W

WEIGHT

	direct	direct / indirect
ø 330 mm	2,3 kg	-
ø 420 mm	3,0 kg	3,1 kg
ø 620 mm	5,1 kg	5,5 kg

Die angegebenen Lichtstromwerte (lm) beziehen sich auf Leuchten mit einem weißen Gehäuse (RAL 9016). Je nach Gehäusefarbe und Durchmesser reduzieren sich diese entsprechend.

All figures of luminous flux (lm) are for fixtures with white housing (RAL 9016). Depending on the housing colour and diameter, the luminous flux is reduced accordingly.

Les valeurs de flux lumineux (lm) indiquées se réfèrent aux luminaires à corps blanc (RAL 9016). En fonction de la couleur du corps et du diamètre, celles-ci sont réduites en conséquence.



UGR ≤ 19 | up to 163 lm/W | IEC 62471: Blue light hazard: RG 0 | DALI switchDIM

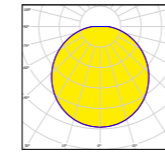

direct

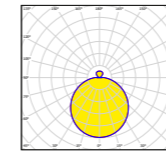

direct/indirect

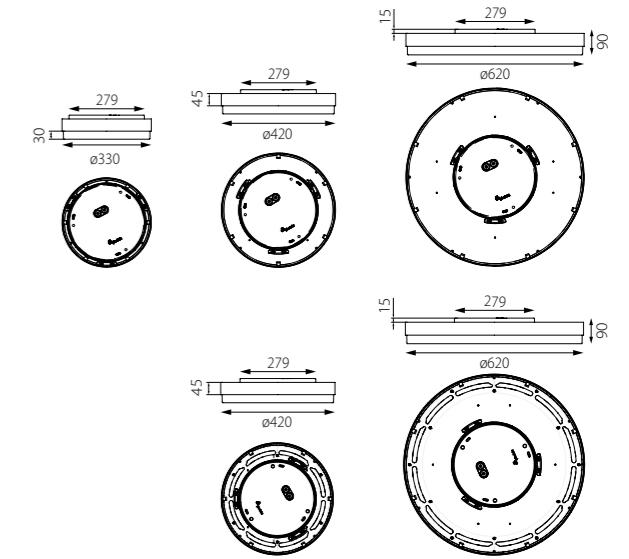

LUMINOUS FLUX (LM) / SYSTEM POWER (W)

4000K satiné	direct			direct/indirect			kg
	low output CRI > 80	high output CRI > 80	dynamic white CRI > 90	low output CRI > 80	high output CRI > 80	dynamic white CRI > 90	
ø 330 mm	1269 lm / 10,5 W	2026 lm / 15 W	1570 lm / 15 W	1924 lm / 12,5 W	3491 lm / 22 W	2231 lm / 18 W	2,2 kg
ø 420 mm	1787 lm / 12,5 W	3225 lm / 22 W	2025 lm / 18 W	1924 lm / 12,5 W	3491 lm / 22 W	2231 lm / 18 W	3,1 kg
ø 620 mm	3400 lm / 22,0 W	6142 lm / 40 W	4544 lm / 39 W	3602 lm / 22 W	6437 lm / 40 W	4762 lm / 39 W	6,1 kg

Die angegebenen Lichtstromwerte (lm) beziehen sich auf Leuchten mit einem weißen Gehäuse (RAL 9016). Je nach Gehäusefarbe und Durchmesser reduzieren sich diese entsprechend.

All figures of luminous flux (lm) are for fixtures with white housing (RAL 9016). Depending on the housing colour and diameter, the luminous flux is reduced accordingly.

Les valeurs de flux lumineux (lm) indiquées se réfèrent aux luminaires à corps blanc (RAL 9016). En fonction de la couleur du corps et du diamètre, celles-ci sont réduites en conséquence.

1 SIZE

- ø 330 mm (direct only)
- ø 420 mm
- ø 620 mm

- 033
- 042
- 062

2 COLOUR

- silver
- white
- black
- RAL of your choice

- 9006
- 9016
- 9005

3 INGRESS PROTECTION

- IP20
- IP54 (direct only)

- C
- Q

4 DIRECT / INDIRECT

- direct
- direct/indirect

- 1
- 2

5 LED

- 3000 K, CRI > 80
- 4000 K, CRI > 80
- 3000 K, CRI > 90
- 4000 K, CRI > 90
- 2700 - 6500 K, dynamic white, CRI > 90

- 830
- 840
- 930
- 940
- HCL

6 OUTPUT / CONTROL

- low output non-dim
- low output DALI
- high output DALI
- dynamic white

- L1
- L3
- H3
- X3

LATERAL DIFFUSER



F52W 1-2-3-4-5-6 S

F52W042-9016Q1840H3S wall, ø 420 mm, white, IP54, direct, 4000 K, CRI > 80, high output DALI, satiné (order sample)

Configure online on KATALOG.PLANLICHT.COM



up to 164 lm/W | IEC 62471: Blue light hazard: RG 0 | DALI switchDIM

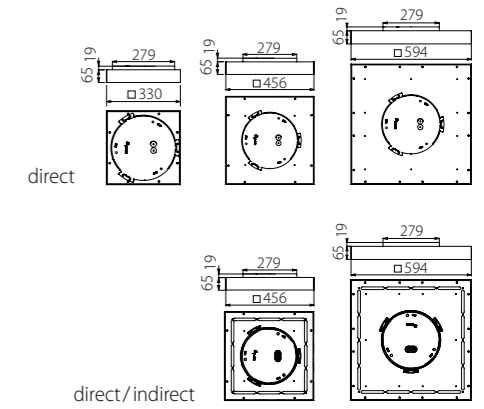
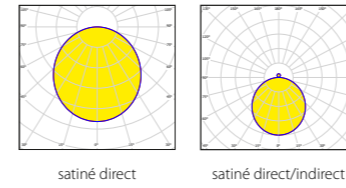

LUMINOUS FLUX (LM) / SYSTEM POWER (W)

4000 K satiné	direct			direct / indirect		
	low output CRI > 80	high output CRI > 80	dynamic white CRI > 90	low output CRI > 80	high output CRI > 80	dynamic white CRI > 90
330 x 330 mm	1469 lm / 10,5 W	2653 lm / 18,5 W	2057 lm / 18,5 W	-	-	-
456 x 456 mm	2882 lm / 21 W	4603 lm / 33 W	3568 lm / 33 W	3041 lm / 21 W	4855 lm / 33 W	3763 lm / 33 W
594 x 594 mm	4866 lm / 31 W	9137 lm / 59 W	6269 lm / 54 W	5044 lm / 31 W	9472 lm / 59 W	6529 lm / 54 W

WEIGHT

	direct	direct / indirect
330 x 330 mm	2,4 kg	-
456 x 456 mm	3,6 kg	3,6 kg
594 x 594 mm	5,4 kg	5,4 kg

Die angegebenen Lichtstromwerte (lm) beziehen sich auf Leuchten mit einem weißen Gehäuse (RAL 9016). Je nach Gehäusefarbe und Durchmesser reduzieren sich diese entsprechend.
All figures of luminous flux (lm) are for fixtures with white housing (RAL 9016). Depending on the housing colour and diameter, the luminous flux is reduced accordingly.
Les valeurs de flux lumineux (lm) indiquées se réfèrent aux luminaires à corps blanc (RAL 9016). En fonction de la couleur du corps et du diamètre, celles-ci sont réduites en conséquence.

<p>1 SIZE</p> <p>330 x 330 mm (direct only) 03Q</p> <p>456 x 456 mm 04Q</p> <p>594 x 594 mm 05Q</p>	<p>2 COLOUR</p> <p> silver 9006</p> <p> white 9016</p> <p> black 9005</p> <p> RAL of your choice ☛</p>	<p>3 DIRECT / INDIRECT</p> <p> direct 1</p> <p> direct/indirect 2</p>
<p>4 LED</p> <p> 3000 K, CRI > 80 830</p> <p> 4000 K, CRI > 80 840</p> <p> 3000 K, CRI > 90 930</p> <p> 4000 K, CRI > 90 940</p> <p> 2700 - 6500 K dynamic white, CRI > 90 HCL</p>	<p>5 OUTPUT / CONTROL</p> <p> low output non-dim L1</p> <p> low output DALI L3</p> <p> high output DALI H3</p> <p> dynamic white X3</p>	

F61W **1-2-F-3-4-5-S**
F61W04Q - 9016F1830H3S wall, 456 x 456 mm, white, IP 50, direct, 3000 K, CRI > 80, high output DALI, satiné (order sample) [Configure online on KATALOG.PLANLICHT.COM](#)



up to 163 lm/W | IEC 62471: Blue light hazard: RG 0 | DALI switchDIM

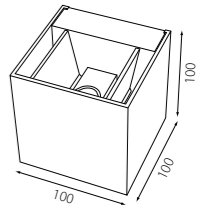
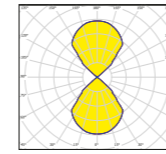
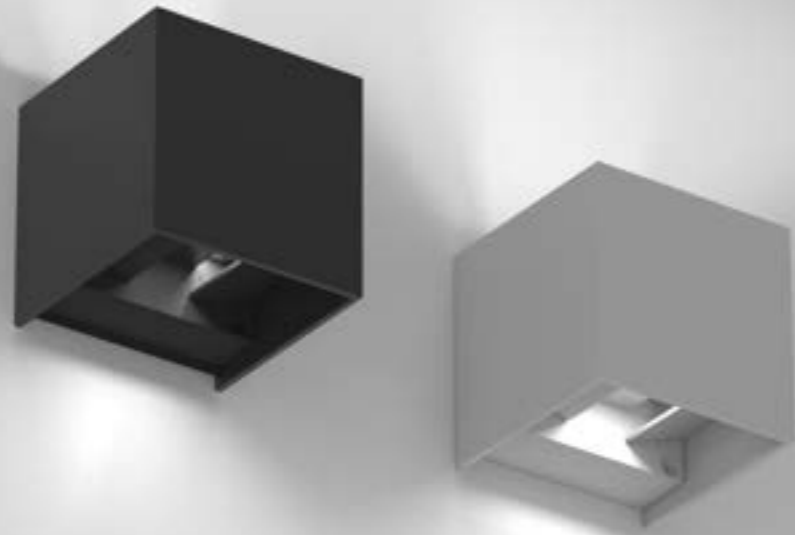

LUMINOUS FLUX (LM) / SYSTEM POWER (W)

	white	black	silver		
3000K CRI > 90	544lm	454lm	509lm	7,9W	0,9kg

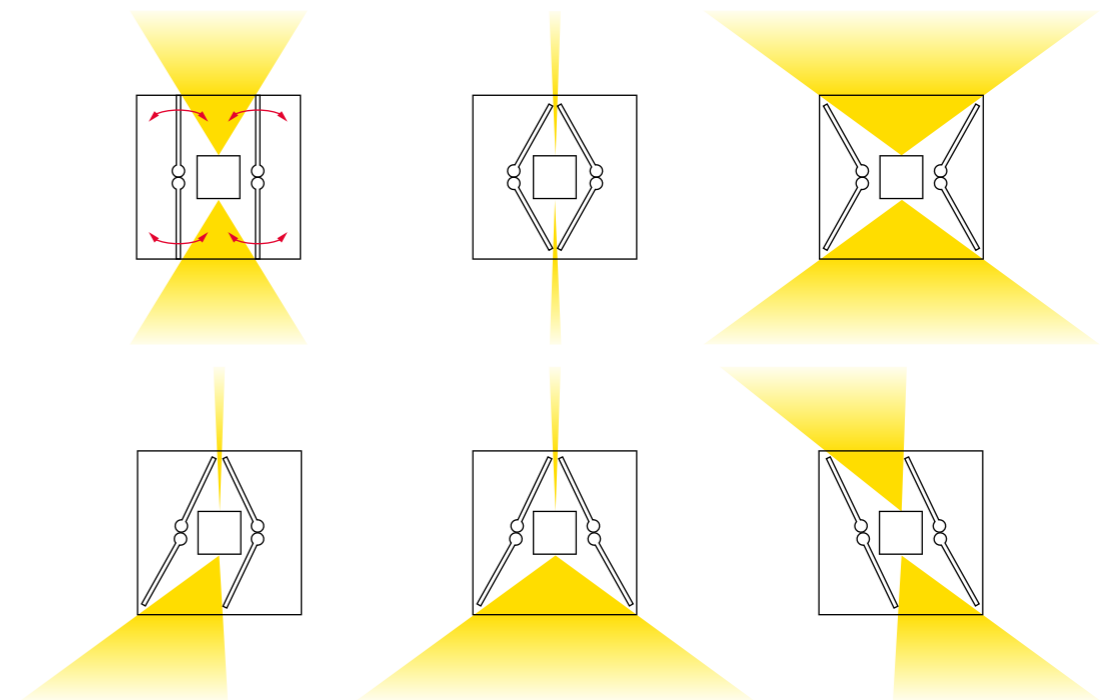

1 COLOUR **2 LED** **3 ORDER NUMBER**

	silver		3000K	740112WS-V5
	white		3000K	740112SW-V5
	black		3000K	740112SI-V5



IEC 62471: Blue light hazard: RG ≤ 1

wall 90 / wall 90 grid

Wandleuchte
Wall luminaire
Applique murale

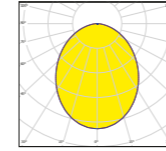

LUMINOUS FLUX (LM) / SYSTEM POWER (W)

3000K/CRI>80	40lm	2,5W	0,2kg
--------------	------	------	-------

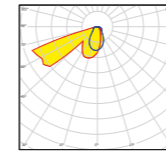

LUMINOUS FLUX (LM) / SYSTEM POWER (W)

3000K/CRI>80	56lm	2,5W	0,2kg
--------------	------	------	-------

WALL 90 / WALL 90 GRID | WALL

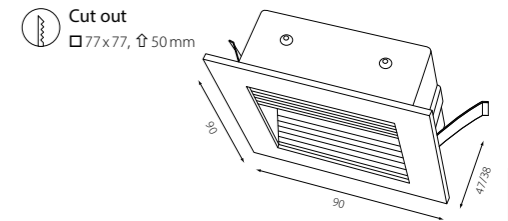
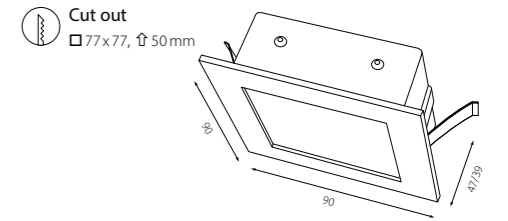

ACCESSORIES

Wall recessed box	740030
Plaster frame	740031

740030 - recommended for recessing

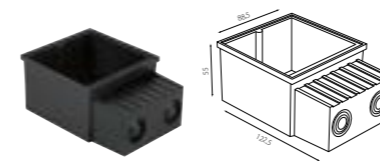

740031 - optional for plaster > 15 mm

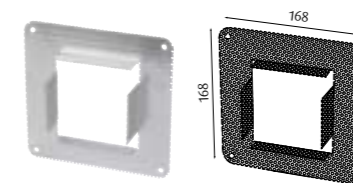

1 TYPE 2 COLOUR 3 LED 4 ORDER NUMBER

wall 90	white	3000K	740027WS-WW
	pearl chrome	3000K	740027PC-WW
wall 90 grid	white	3000K	740029WS-WW
	pearl chrome	3000K	740029PC-WW



IEC 62471: Blue light hazard: RG ≤ 1

EINBAU - LEUCHTEN

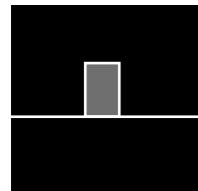

Recessed luminaires
Luminaires encastré

PROFILLEUCHTEN | PROFILE LUMINAIRES | LUMINAIRES PROFILÉS

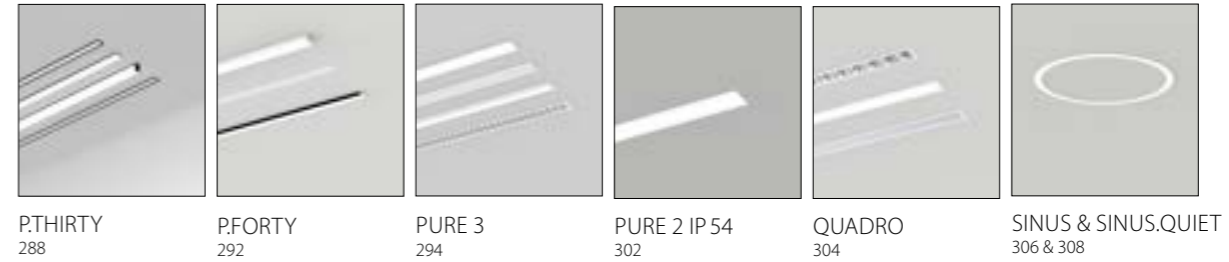

P.THIRTY
288

P.FORTY
292

PURE 3
294

PURE 2 IP 54
302

QUADRO
304

SINUS & SINUS.QUIET
306 & 308

FLÄCHENLEUCHTEN | AREA LUMINAIRES | LAMPES DE SURFACE

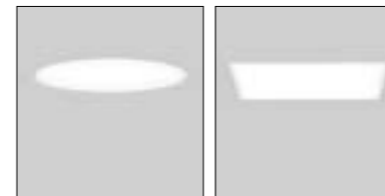

OPHELIA
310

LIHA
314

DOWNLIGHTS & STRAHLER | DOWNLIGHTS & SPOTLIGHTS | DOWNLIGHTS & PROJECTEURS



ANTO+
318

ZENIT
322

METEOR
328

DIVA
332

COSMO
336

MIZAR
338

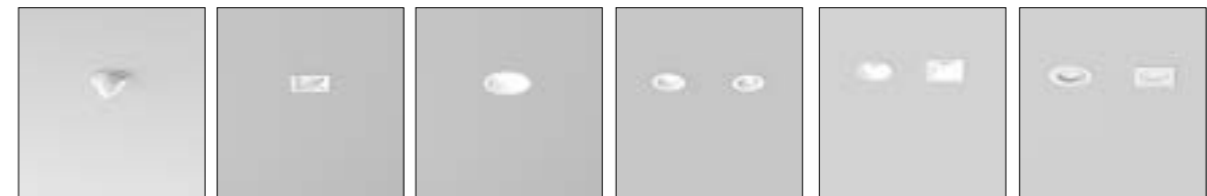

TAURUS
340

METIS
342

LEDA
344

OSLO/TOULON
346

SPOT 85 RZ/90 EZ
348

SPOT 82
350

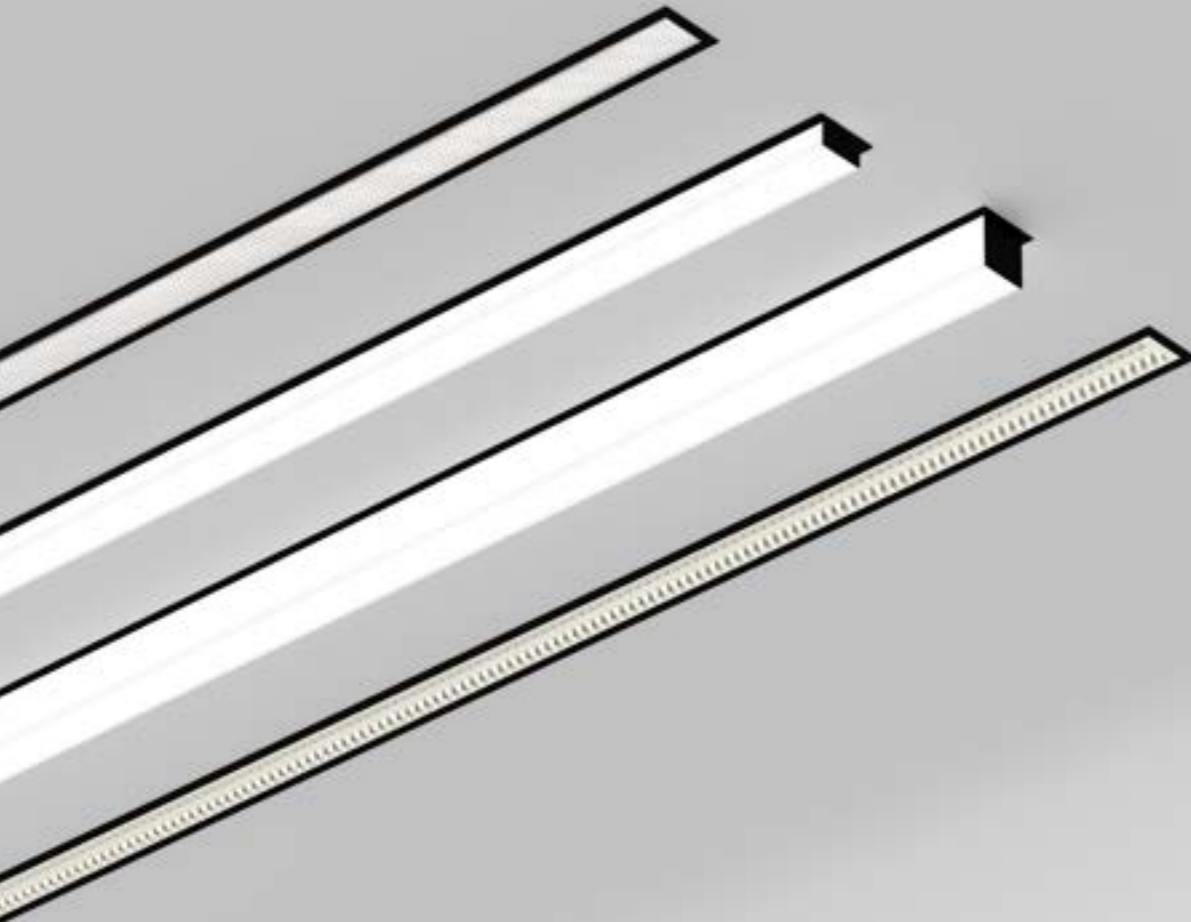

1 SIZE	2 COLOUR	3 INGRESS PROTECTION
565 mm (non dim only)	056 silver	9006 IP20
835 mm	083 white	9016
1195 mm	119 black	9005
1465 mm	146 RAL of your choice	
2907 mm	290	
3539 mm	353	
4349 mm	434	

4 LED	4 OUTPUT / CONTROL	5 OPTIC
2700 K, CRI > 90	927 DIFFUSER	satiné
3000 K, CRI > 90	930 low output non-dim	jet black & light
4000 K, CRI > 90	940 low output DALI	microprism*
NEW 4000 K, CRI > 80	840 high output non dim (565 mm)	U-shaped satiné, 15 mm
	high output DALI	U-shaped satiné, 34 mm
	OBD	U-shaped jet black microprism, 15 mm*
	high output non dim	Opto-Balance Darklight®
	high output DALI	BAP high-gloss black chrome*
	very high output non-dim (not 835 mm)	Opto-Balance Darklight®
	very high output DALI (not 835 mm)	BAP high-gloss copper*
		Opto-Balance Darklight®
		BAP high-gloss gold*
		Opto-Balance Darklight®
		BAP high-gloss silver*

P30E 1-2-3-4-5-6

P30E353-9016C1930H35 recessed frame, 3539 mm, white, IP20, direct, 3000 K, CRI > 90, high output DALI, satiné (order sample)

► [Configure online on KATALOG.PLANLICHT.COM](#)

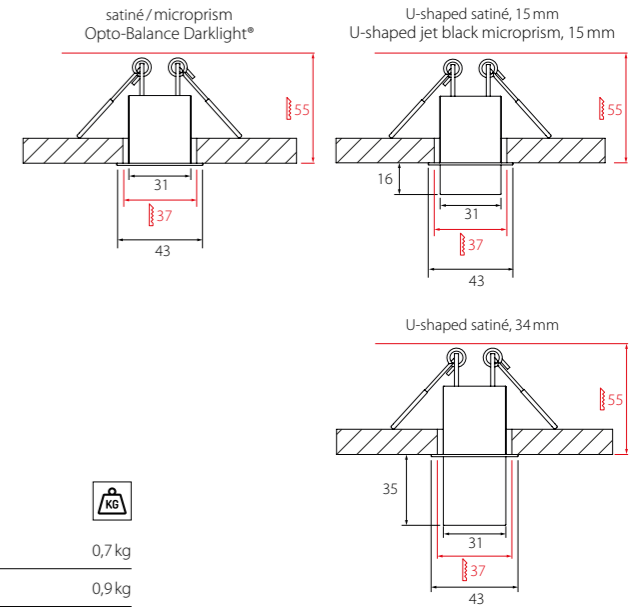
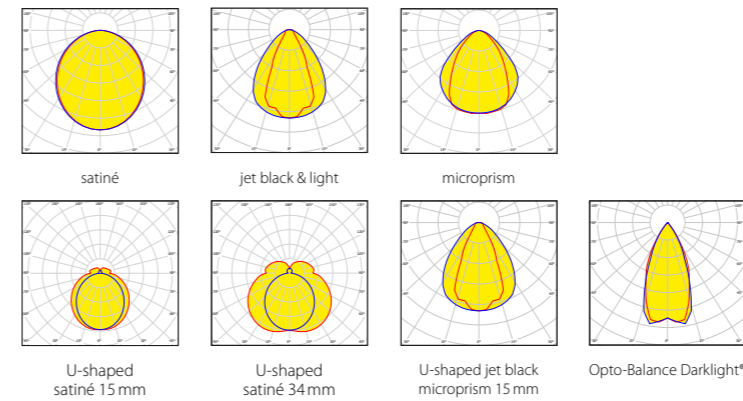

LUMINOUS FLUX (LM) / SYSTEM POWER (W)

4000 K satiné CRI > 80	low output	high output	
557 mm	930 lm / 8W	1324 lm / 11,5W	0,7 kg
827 mm	1388 lm / 10,5W	1981 lm / 15,5W	0,9 kg
1187 mm	1999 lm / 14,5W	2855 lm / 21 W	1,2 kg
1457 mm	2457 lm / 17W	3512 lm / 25W	1,4 kg
2899 mm	4895 lm / 34W	7008 lm / 50W	2,7 kg
3531 mm	5961 lm / 43W	8537 lm / 62W	3,3 kg
4341 mm	7331 lm / 51 W	10503 lm / 74W	4,0 kg

(based on optic Q)

COMPARE COVER 1457 MM, 4000 K, CRI > 80

	low output	high output	very high output
satiné	2457 lm	3512 lm	
jet black & light	506 lm	723 lm	
microprism*	2534 lm	3624 lm	
U-shaped satiné (15 mm)	2588 lm	3710 lm	
U-shaped satiné (34 mm)	2724 lm	3903 lm	
U-shaped jet black microprism (15 mm)	1419 lm	2020 lm	
Opto-Balance Darklight® high-gloss silver		1941 lm	3836 lm

*Der angegebene Lichtstrom bezieht sich auf die Leuchte mit klarer mikroprismatischer Abdeckung. Die Leuchte wird mit satiniertes Folie zur Erhöhung der Homogenität geliefert (Direkt strahlend: -13,9%, direkt/indirekt strahlend: -6,9% Lichtstrom). Die angegebenen Lichtstromwerte (lm) beziehen sich auf Leuchten mit einem weißen Gehäuse (RAL 9016). Je nach Gehäusefarbe und Länge reduzieren sich diese entsprechend (bezieht sich nur auf U-förmige Abdeckungen).

The indicated luminous flux corresponds to the luminaire with a clear microprismatic diffuser. The luminaire is delivered with a satinized-foil for increased homogeneity (direct: -13,9%, direct-indirect: -6,9% luminous flux). All figures of luminous flux (lm) are for fixtures with white housing (RAL 9016). Depending on the housing colour and length, the luminous flux is reduced accordingly. This only applies to U-shaped optics.

Le flux lumineux indiqué correspond au luminaire avec diffuseur microprismatique transparent. Le luminaire est livré avec un film satiné pour optimiser l'homogénéité (direct: -13,9%, direct-indirect: -6,9% sur le flux lumineux). Les valeurs de flux lumineux (lm) indiquées se réfèrent aux luminaires à corps blanc (RAL 9016). En fonction de la couleur du corps et de la longueur, celles-ci sont réduites en conséquence (se réfère uniquement aux caches en forme de U).

P.THIRTY PROFILE SYSTEM 354



Down to UGR ≤ 16 | up to 160 lm/W | up to 2905 lm/m | IEC 62471: Blue light hazard: RG 0 | push switchDIM

NEW p.thirty IP 44

Einbauleuchte
Recessed luminaire
Luminaire encastré

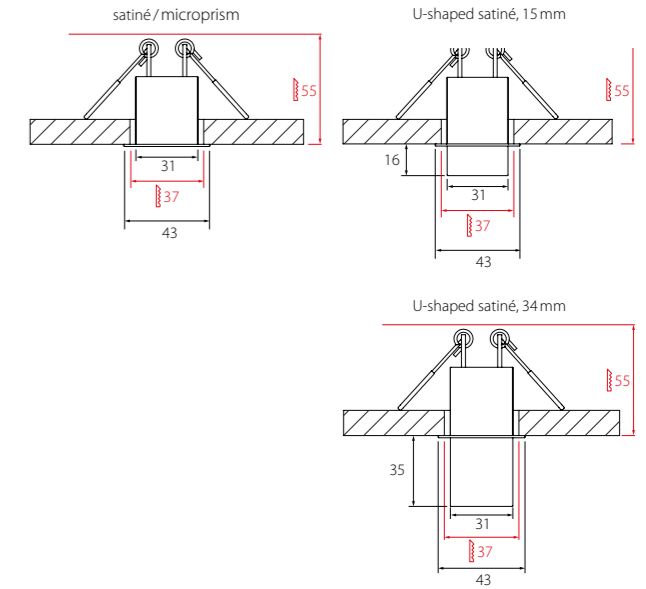
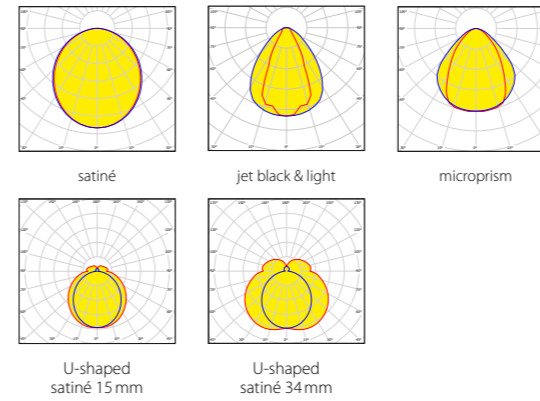
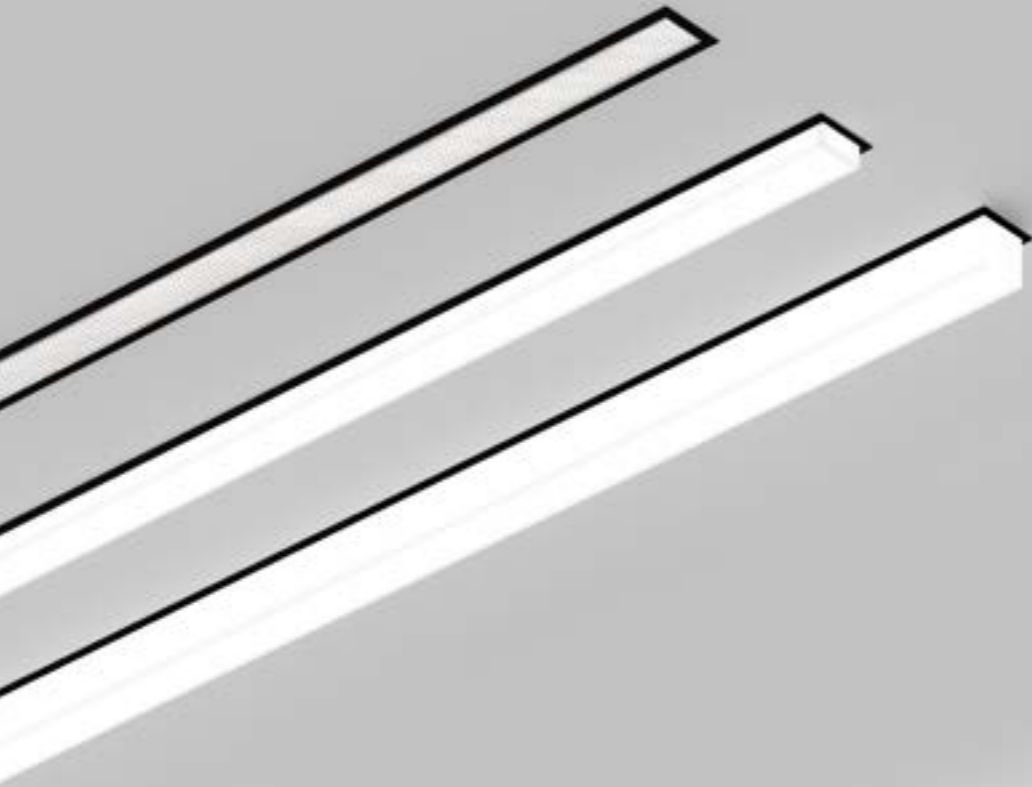

LUMINOUS FLUX (LM) / SYSTEM POWER (W)

4000 K satiné CRI > 80	low output	high output	
557 mm	930lm/8W	1324lm/11,5W	0,7kg
827 mm	1388lm/10,5W	1981lm/15,5W	0,9kg
1187 mm	1999lm/14,5W	2855lm/21W	1,2kg
1457 mm	2457lm/17W	3512lm/25W	1,4kg

(based on optic Q)

COMPARE COVER 1457 MM, 4000 K, CRI > 80

	low output	high output
satiné	2457lm	3512lm
jet black & light	506lm	723lm
microprism*	2534lm	3624lm
U-shaped satiné (15 mm)	2588lm	3710lm
U-shaped satiné (34 mm)	2724lm	3903lm

*Der angegebene Lichtstrom bezieht sich auf die Leuchte mit klarer mikroprismatischer Abdeckung. Die Leuchte wird mit satiniertes Folie zur Erhöhung der Homogenität geliefert (Direkt strahlend: -13,9% , direkt/indirekt strahlend: -6,9% Lichtstrom). Die angegebenen Lichtstromwerte (lm) beziehen sich auf Leuchten mit einem weißen Gehäuse (RAL 9016). Je nach Gehäusefarbe und Länge reduzieren sich diese entsprechend (bezieht sich nur auf U-förmige Abdeckungen).

The indicated luminous flux corresponds to the luminaire with a clear microprismatic diffuser. The luminaire is delivered with a satined-foil for increased homogeneity (direct: -13,9%, direct-indirect: -6,9% luminous flux). All figures of luminous flux (lm) are for fixtures with white housing (RAL 9016). Depending on the housing colour and length, the luminous flux is reduced accordingly. This only applies to U-shaped optics.

Le flux lumineux indiqué correspond au luminaire avec diffuseur microprismatique transparent. Le luminaire est livré avec un film satiné pour optimiser l'homogénéité (direct: -13,9%, direct-indirect: -6,9% sur le flux lumineux). Les valeurs de flux lumineux (lm) indiquées se réfèrent aux luminaires à corps blanc (RAL 9016). En fonction de la couleur du corps et de la longueur, celles-ci sont réduites en conséquence (se réfère uniquement aux caches en forme de U).

1 SIZE

- 565 mm (non dim only)
- 835 mm
- 1195 mm
- 1465 mm

2 COLOUR

- 056** silver
- 083** white
- 119** black
- 146** RAL of your choice

3 INGRESS PROTECTION

IP44 **P**

4 LED

- 2700 K, CRI > 90
- 3000 K, CRI > 90
- 4000 K, CRI > 90
- 4000 K, CRI > 80

4 OUTPUT / CONTROL

- DIFFUSER**
- 927** low output non-dim
 - 930** low output DALI
 - 940** high output non dim (565 mm)
 - 840** high output DALI

5 OPTIC

- satiné **S**
- jet black & light **J** **NEW**
- microprism* **M**
- U-shaped satiné, 15 mm **U**
- U-shaped satiné, 34 mm **Q**

* UGR-optimised, configure online

P30E **1-2-3-4-5-6**

P30E146-9016P1930H35 recessed frame, 1465 mm, white, IP44, direct, 3000 K, CRI > 90, high output DALI, satiné (order sample)

➔ [Configure online on KATALOG.PLANLICHT.COM](#)

P.THIRTY PROFILE SYSTEM 354



Down to UGR ≤ 19 | up to 160lm/W | up to 2905lm/m | IEC 62471: Blue light hazard: RG 0 | push switchDIM

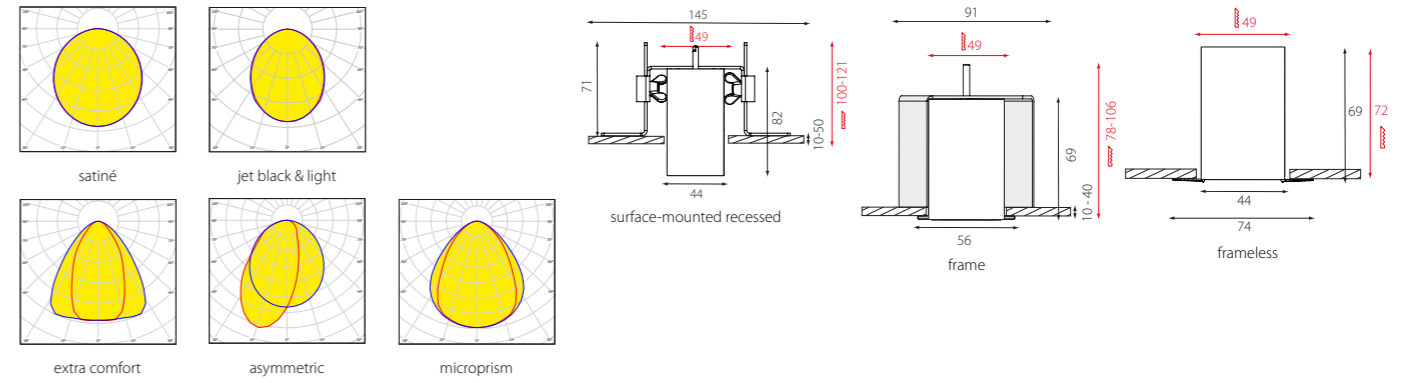

LUMINOUS FLUX (LM) / SYSTEM POWER (W)

4000K satiné	low output CRI > 80	high output CRI > 80	dynamic white CRI > 90	A	E	F
571 / 586 mm	769 lm / 7,5W	1339 lm / 13,5W	1014 lm / 14,5 W	1,2 kg	1,3 kg	1 kg
851 / 866 mm	1185 lm / 11,5W	2073 lm / 19,5W	1569 lm / 19,5 W	1,6 kg	1,7 kg	1,4 kg
1131 / 1146 mm	1600 lm / 15W	2804 lm / 24W	2123 lm / 25 W	2,1 kg	2,1 kg	1,8 kg
1411 / 1426 mm	2014 lm / 17,5W	3532 lm / 31 W	2674 lm / 31 W	2,6 kg	2,6 kg	2,3 kg
1691 / 1706 mm	2427 lm / 21 W	4257 lm / 37W	3223 lm / 36W	3,1 kg	2,9 kg	2,7 kg
2251 / 2266 mm	3250 lm / 27W	5697 lm / 49W	4313 lm / 48W	3,9 kg	3,7 kg	3,5 kg
2815 / 2830 mm	4069 lm / 35W	7123 lm / 62W	5392 lm / 62W	5,1 kg	5,1 kg	4,8 kg
3375 / 3390 mm	4884 lm / 41 W	8536 lm / 74W	6462 lm / 73W	6,0 kg	5,8 kg	5,5 kg
4495 / 4510 mm	6502 lm / 54W	11323 lm / 98W	8572 lm / 95W	7,7 kg	7,3 kg	7,0 kg

(based on optic S, DALI)

COMPARE COVER 1414 MM

	low output CRI > 80	high output CRI > 80	dynamic white CRI > 90
satiné	2014 lm	3532 lm	2674 lm
jet black & light	628 lm	1101 lm	834 lm
microprism *	2047 lm	3590 lm	2718 lm
extra comfort	2333 lm	-	-
asymmetric	1687 lm	2958 lm	2239 lm

COMPARE LIGHT COLOUR 1414 MM, SATINÉ

	low output CRI > 80	
4000 K, CRI > 80	3532 lm	-1,9%
4000 K, CRI > 90	3465 lm	
3000 K, CRI > 80	3371 lm	-3,1%
3000 K, CRI > 90	3265 lm	

MANDATORY ACCESSORY FOR SURFACE-MOUNTED RECESSED

P40-MOB-F-1 Recessed-mount-bracket

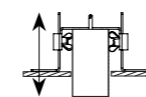

*Der angegebene Lichtstrom bezieht sich auf die Leuchte mit klarer mikroprismatischer Abdeckung. Die Leuchte wird mit satinierter Folie zur Erhöhung der Homogenität geliefert (-23% Lichtstrom).

The indicated luminous flux corresponds to the luminaire with a clear microprismatic diffuser. The luminaire is delivered with a satinized-foil for increased homogeneity (-23% luminous flux)

Le flux lumineux indiqué correspond au luminaire avec diffuseur microprismatique transparent. Le luminaire est livré avec un film satiné pour optimiser l'homogénéité (-23% sur le flux lumineux).

1 MOUNTING

- frame
- frameless (ALUB only)
- surface-mounted recessed

2 SIZE

E	E	F	A
586 mm	058	571 mm	057
866 mm	086	851 mm	085
1146 mm	114	1131 mm	113
1426 mm	142	1411 mm	141
1706 mm	170	1691 mm	169
2266 mm	226	2251 mm	225
2830 mm	283	2815 mm	281
3390 mm	339	3375 mm	337
4510 mm	451	4495 mm	449

3 COLOUR

- silver 9006
- aluminium blank (only frameless) ALUB
- white 9016
- black 9005
- RAL of your choice

4 LED

- 3000 K, CRI > 80 830
- 4000 K, CRI > 80 840
- 3000 K, CRI > 90 930
- 4000 K, CRI > 90 940
- 2700 - 6500 K dynamic white, CRI > 90 HCL

5 OUTPUT / CONTROL

- low output non-dim L1
- low output DALI L3
- high output DALI H3
- dynamic white X3

6 OPTIC

- satiné S
- jet black & light J **NEW**
- microprism* M
- asymmetric A
- extra comfort* E

*UGR-optimised, configure online

P40E 1 2 3 C1 4 5 6

P40E141 - 9016C1840H3S frame, 1146 mm, white, IP20, direct, 4000K, CRI > 80, high output DALI, satiné (order sample)

Configure online on KATALOG.PLANLICHT.COM



Down to UGR ≤ 19 | up to 139 lm/W | up to 2586 lm/m | IEC 62471: Blue light hazard: RG 0 | DALI switchDIM

P.FORTY PROFILE SYSTEM 364



pure 3 frame

Einbauleuchte
Recessed luminaire
Luminaire encastré



1 SIZE

satiné/jet black & light/microprism	asymmetric	BAP
590 mm 059	589 mm 058	
870 mm 087	869 mm 086	
1150 mm 115	1149 mm 114	1150 mm 115
1430 mm 143	1429 mm 142	1430 mm 143
1710 mm 171	1709 mm 170	
2270 mm 227	2275 mm 225	2275 mm 227
2834 mm 283	2835 mm 283	2835 mm 283
3394 mm 339	3395 mm 339	3400 mm 340
4238 mm 423	4239 mm 423	4236 mm 423

4 LED

3000 K, CRI > 80	830
4000 K, CRI > 80	840
3000 K, CRI > 90	930
4000 K, CRI > 90	940
2700 - 6500 K dynamic white, CRI > 90	HCL

2 COLOUR

silver	9006
white	9016
black	9005
RAL of your choice	

5 OUTPUT/CONTROL

low output non-dim	L1
low output DALI	L3
high output DALI	H3
dynamic white	X3

3 INGRESS PROTECTION

IP20 (asymmetric & BAP)	C
IP40 (satiné, jet black & light, microprism)	E

6 OPTIC

satiné	S
jet black & light	J NEW
microprism*	M
asymmetric	A
BAP high-gloss silver*	B

* UGR-optimised, configure online

P33E 1-2 3 4 5 6

P33E059-9016E1840H3S frame, 590 mm, white, IP40, direct, 4000 K, CRI > 80, high output DALI, satiné (order sample)

► Configure online on [KATALOG.PLANLICHT.COM](https://www.katalog.planlicht.com)

PURE 3 FRAME | RECESSED

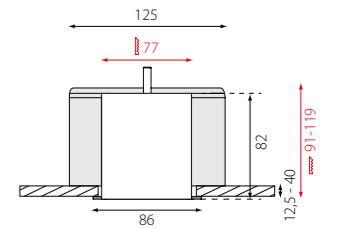
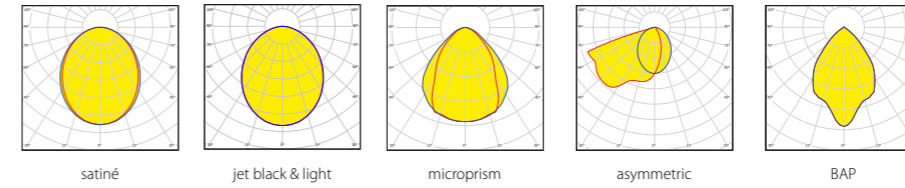

LUMINOUS FLUX (LM) / SYSTEM POWER (W)

4000K satiné	low output CRI > 80	high output CRI > 80	dynamic white CRI > 90	
590 mm	735 lm / 8,2W	1328 lm / 15W	1005 lm / 16W	1,7 kg
870 mm	1126 lm / 12,5W	2033 lm / 21W	1539 lm / 22W	2,3 kg
1150 mm	1514 lm / 16,5W	2734 lm / 28W	2070 lm / 28W	2,8 kg
1430 mm	1900 lm / 19,5W	3429 lm / 35W	2596 lm / 34W	3,5 kg
1710 mm	2283 lm / 23W	4119 lm / 40W	3118 lm / 40W	4,0 kg
2270 mm	3040 lm / 30W	5485 lm / 54W	4152 lm / 52W	5,1 kg
2834 mm	3787 lm / 39W	6831 lm / 69W	5171 lm / 68W	6,9 kg
3394 mm	4522 lm / 45W	8157 lm / 81W	6175 lm / 80W	8,0 kg
4238 mm	5604 lm / 59W	10109 lm / 104W	7653 lm / 102W	10,5 kg

(based on optic S, DALI)

COMPARE COVER 1414 MM

	low output CRI > 80	high output CRI > 80	dynamic white CRI > 90
satiné	1900 lm	3429 lm	2596 lm
jet black & light	478 lm	863 lm	653 lm
microprism*	2096 lm	3782 lm	2863 lm
BAP	2168 lm	3792 lm	2402 lm
asymmetric	1857 lm	3534 lm	2045 lm

COMPARE LIGHT COLOUR 1414 MM SATINÉ, LOW OUTPUT

4000 K, CRI > 80	1900 lm	-1,3 %
4000 K, CRI > 90	1875 lm	
3000 K, CRI > 80	1832 lm	
3000 K, CRI > 90	1775 lm	-3,1 %

CUT OUT

SIZE	WIDTH	DEPTH
all lengths - 9 mm	77 mm	91-119 mm

*Der angegebene Lichtstrom bezieht sich auf die Leuchte mit klarer mikroprismatischer Abdeckung. Die Leuchte wird mit satiniertes Folie zur Erhöhung der Homogenität geliefert (-28,2% Lichtstrom).

The indicated luminous flux corresponds to the luminaire with a clear microprismatic diffuser. The luminaire is delivered with a satiné-foil for increased homogeneity (-28,2% luminous flux).

Le flux lumineux indiqué correspond au luminaire avec diffuseur microprismatique transparent. Le luminaire est livré avec un film satiné pour optimiser l'homogénéité (-28,2% sur le flux lumineux).

PURE 3 PROFILE SYSTEM 378

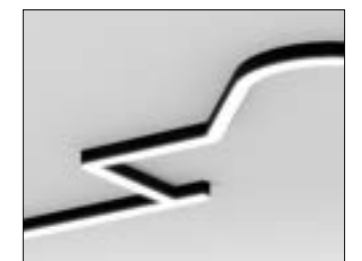

Down to UGR ≤ 16 | up to 114 lm / W | up to 2704 lm / m | IEC 62471: Blue light hazard: RG 0 | DALI switchDIM

pure 3 frameless

Einbauleuchte
Recessed luminaire
Luminaire encastré

PURE 3 FRAMELESS | RECESSED

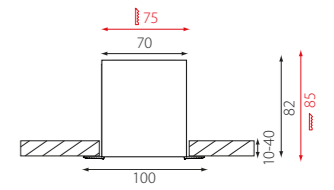
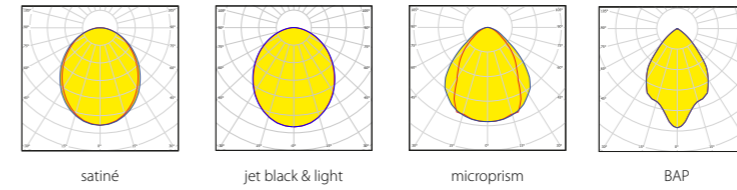
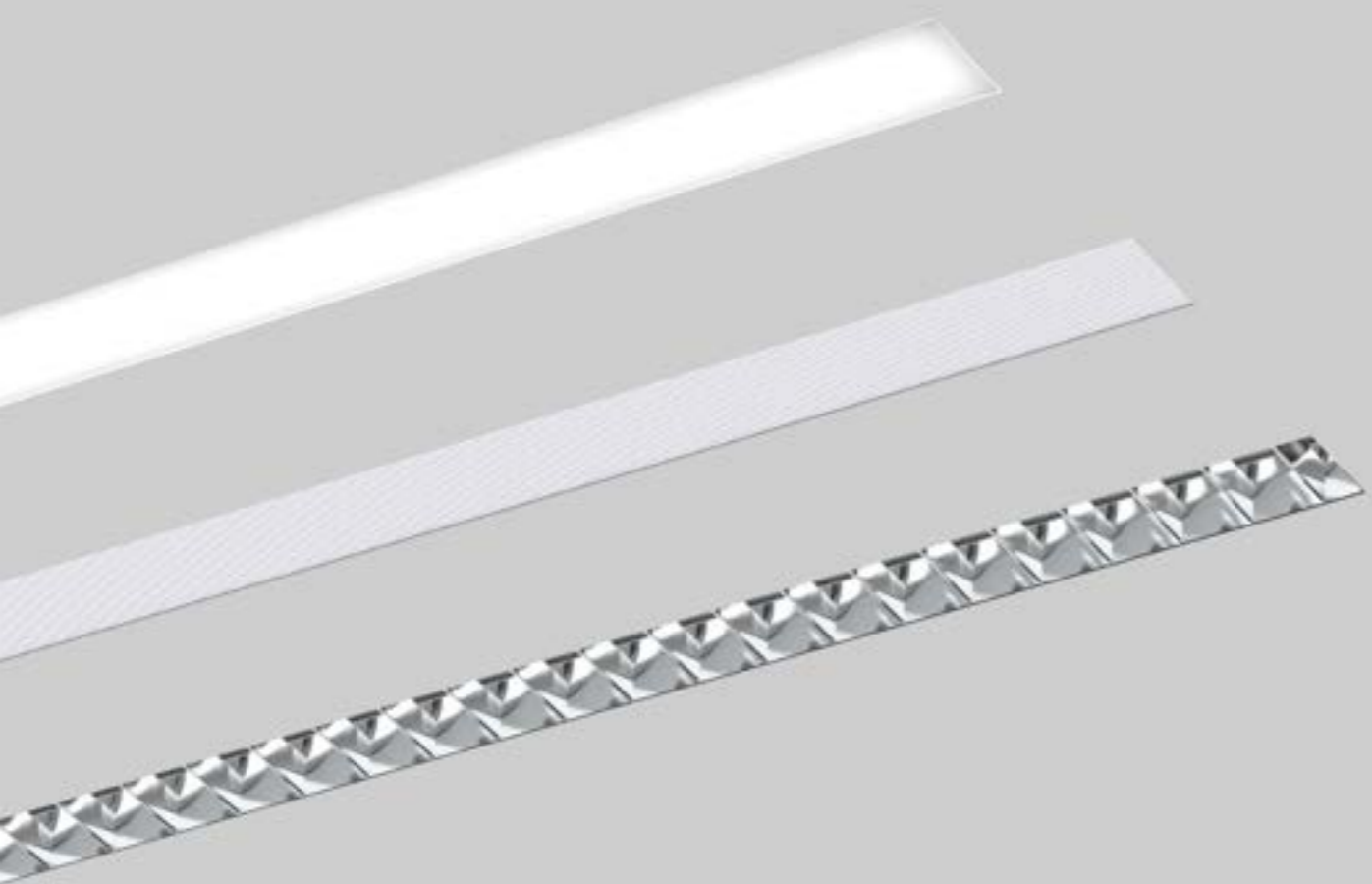

LUMINOUS FLUX (LM) / SYSTEM POWER (W)

4000K satiné	low output CRI > 80	high output CRI > 80	dynamic white CRI > 90	
574 mm	735 lm / 8,2W	1328 lm / 15W	1005 lm / 16W	1,6 kg
854 mm	1126 lm / 12,5W	2033 lm / 21W	1539 lm / 22W	2,1 kg
1134 mm	1514 lm / 16,5W	2734 lm / 28W	2070 lm / 28W	2,7 kg
1414 mm	1900 lm / 19,5W	3429 lm / 35W	2596 lm / 34W	3,4 kg
1694 mm	2283 lm / 23W	4119 lm / 40W	3118 lm / 40W	4,0 kg
2254 mm	3040 lm / 30W	5485 lm / 54W	4152 lm / 52W	5,1 kg
2818 mm	3787 lm / 39W	6831 lm / 69W	5171 lm / 68W	6,7 kg
3378 mm	4522 lm / 45W	8157 lm / 81W	6175 lm / 80W	7,9 kg
4222 mm	5604 lm / 59W	10109 lm / 104W	7653 lm / 102W	10,1 kg

(based on optic S, DALI)

COMPARE COVER 1414 MM

	low output CRI > 80	high output CRI > 80	dynamic white CRI > 90
satiné	1900 lm	3429 lm	2596 lm
jet black & light	478 lm	863 lm	653 lm
microprism*	2096 lm	3782 lm	2863 lm
BAP	2168 lm	3792 lm	2402 lm
asymmetric	1857 lm	3534 lm	2045 lm

COMPARE LIGHT COLOUR 1414 MM, SATINÉ, LOW OUTPUT

4000 K, CRI > 80	1900 lm	-1,3%
4000 K, CRI > 90	1875 lm	
3000 K, CRI > 80	1832 lm	-3,1%
3000 K, CRI > 90	1775 lm	

CUT OUT

SIZE	WIDTH	DEPTH
all lengths + 1 mm	75 mm	85 mm

*Der angegebene Lichtstrom bezieht sich auf die Leuchte mit klarer mikroprismatischer Abdeckung. Die Leuchte wird mit satiniertes Folie zur Erhöhung der Homogenität geliefert (-28,2% Lichtstrom).

The indicated luminous flux corresponds to the luminaire with a clear microprismatic diffuser. The luminaire is delivered with a satinated-foil for increased homogeneity (-28,2% luminous flux).

Le flux lumineux indiqué correspond au luminaire avec diffuseur microprismatique transparent. Le luminaire est livré avec un film satiné pour optimiser l'homogénéité (-28,2% sur le flux lumineux).

1 SIZE

satiné/jet black & light/ microprism	BAP		
574 mm	057		
854 mm	085		
1134 mm	113	1134 mm	113
1414 mm	141	1414 mm	141
1694 mm	169		
2254 mm	225	2259 mm	225
2818 mm	281	2819 mm	281
3378 mm	337	3384 mm	338
4222 mm	422	4220 mm	422

2 INGRESS PROTECTION

- IP20 (asymmetric & BAP)
- IP40 (satiné, jet black & light, microprism)

3 LED

- 3000 K, CRI > 80 **830**
- 4000 K, CRI > 80 **840**
- 3000 K, CRI > 90 **930**
- 4000 K, CRI > 90 **940**
- 2700 - 6500 K dynamic white, CRI > 90 **HCL**

4 OUTPUT / CONTROL

- low output non-dim
- low output DALI
- high output DALI
- dynamic white

- L1**
- L3**
- H3**
- X3**

5 OPTIC

- satiné
- jet black & light
- microprism*
- BAP*

- S**
- J** **NEW**
- M**
- B**

*UGR-optimised, configure online

P33F 1-ALUB 2 1 3 4 5

P33F057 - ALUBE1840H3S frameless, 574 mm, alu blank, IP40, direct, 4000K, CRI > 80, high output DALI, satiné (order sample)

► [Configure online on KATALOG.PLANLICHT.COM](#)

PURE 3 PROFILE SYSTEM 378



Down to UGR ≤ 16 | up to 114 lm/W | up to 2704 lm/m | IEC 62471: Blue light hazard: RG 0 | DALI switchDIM

pure 3 vario

Einbauleuchte
Recessed luminaire
Luminaire encastré

PURE 3 VARIO | RECESSED

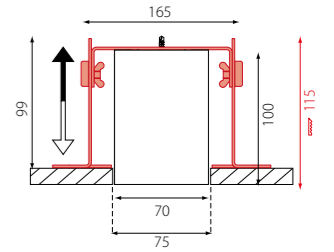
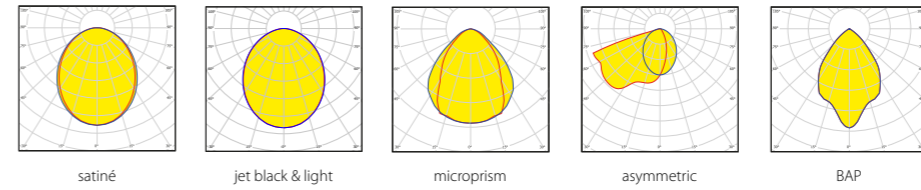
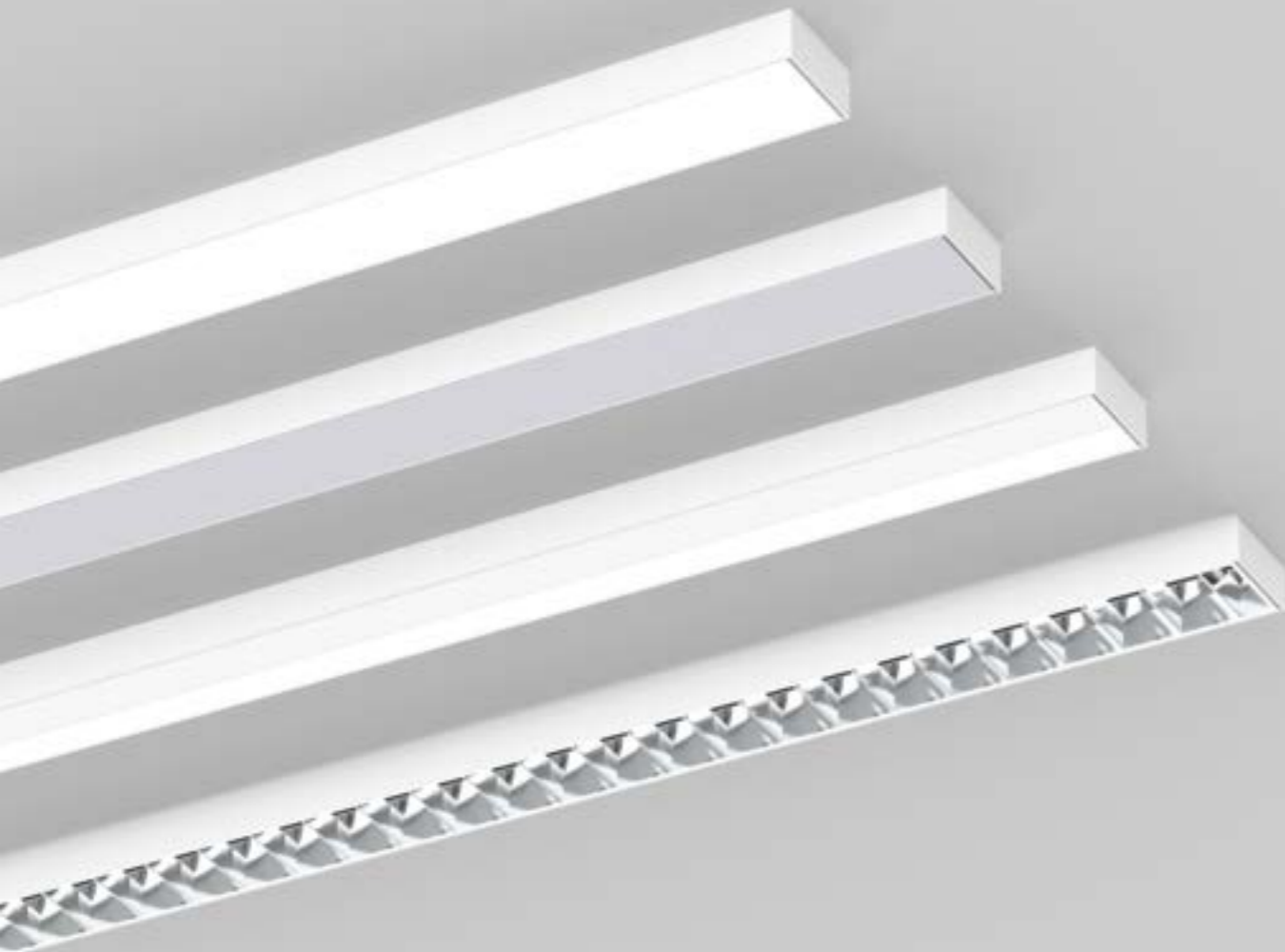

LUMINOUS FLUX (LM) / SYSTEM POWER (W)

4000K satiné	low output CRI > 80	high output CRI > 80	dynamic white CRI > 90	1,6 kg 2,1 kg 2,7 kg 3,4 kg 4,0 kg 5,1 kg 6,7 kg 7,9 kg 10,1 kg <small>(based on optic S, DALI)</small>
574 mm	735 lm / 8,2W	1328 lm / 15W	1005 lm / 16W	
854 mm	1126 lm / 12,5W	2033 lm / 21W	1539 lm / 22W	
1134 mm	1514 lm / 16,5W	2734 lm / 28W	2070 lm / 28W	
1414 mm	1900 lm / 19,5W	3429 lm / 35W	2596 lm / 34W	
1694 mm	2283 lm / 23W	4119 lm / 40W	3118 lm / 40W	
2254 mm	3040 lm / 30W	5485 lm / 54W	4152 lm / 52W	
2818 mm	3787 lm / 39W	6831 lm / 69W	5171 lm / 68W	
3378 mm	4522 lm / 45W	8157 lm / 81W	6175 lm / 80W	
4222 mm	5604 lm / 59W	10109 lm / 104W	7653 lm / 102W	

COMPARE COVER 1414 MM, 4000 K, CRI > 80

	low output CRI > 80	high output CRI > 80	dynamic white CRI > 90
satiné	1900 lm	3429 lm	2596 lm
jet black & light	478 lm	863 lm	653 lm
microprism*	2096 lm	3782 lm	2863 lm
BAP	2168 lm	3792 lm	2402 lm
asymmetric	1857 lm	3534 lm	2045 lm

COMPARE LIGHT COLOUR 1414 MM SATINÉ, LOW OUTPUT

4000 K, CRI > 80	1900 lm	-1,3%
4000 K, CRI > 90	1875 lm	
3000 K, CRI > 80	1832 lm	-3,1%
3000 K, CRI > 90	1775 lm	

MANDATORY ACCESSORY FOR SURFACE-MOUNTED RECESSED

Einbaubügel paarweise | Recessed-mount bracket in pairs | Étriers d'encastrement par paire

P33-MOB-F-2

OPTIONAL ITEMS

Set for embedding in concrete | **P33-BETON**

CUT OUT

SIZE	WIDTH	DEPTH
all lengths + 5 mm	75 mm	115 mm

PURE 3 PROFILE SYSTEM 378



1 SIZE

satiné/jet black & light/microprism	asymmetric	BAP
574 mm 057	573 mm 057	-
854 mm 085	853 mm 085	-
1134 mm 113	1133 mm 113	1134 mm 113
1414 mm 141	1413 mm 141	1414 mm 141
1694 mm 169	1693 mm 169	-
2254 mm 225	2259 mm 225	2259 mm 225
2818 mm 281	2819 mm 281	2819 mm 281
3378 mm 337	3379 mm 337	3384 mm 338
4222 mm 422	4223 mm 422	4220 mm 422

2 COLOUR

	silver	9006
	white	9016
	black	9005
	RAL of your choice	

3 INGRESS PROTECTION

	IP20 (asymmetric & BAP)	C
	IP40 (satiné, jet black & light, microprism)	E

4 LED

	3000 K, CRI > 80	830
	4000 K, CRI > 80	840
	3000 K, CRI > 90	930
	4000 K, CRI > 90	940
	2700 - 6500 K dynamic white, CRI > 90	HCL

5 OUTPUT / CONTROL

	low output non-dim	L1
	low output DALI	L3
	high output DALI	H3
	dynamic white	X3

6 OPTIC

	satiné	S
	jet black & light	J NEW
	microprism*	M
	BAP*	B

* UGR-optimised, configure online

P33A 1-2-3-1-4-5-6

P33A057 - 9016E1840H3S vario, 574 mm, white, IP40, direct, 4000K, CRI > 80, high output DALI, satiné (order sample)

► Configure online on [KATALOG.PLANLICHT.COM](https://www.planlicht.com)



Down to UGR ≤ 16 | up to 114 lm/W | up to 2704 lm/m | IEC 62471: Blue light hazard: RG 0 | DALI switchDIM

pure 3 triflect

Einbauleuchte
Recessed luminaire
Luminaire encastré



PURE 3 TRIFLECT | RECESSED

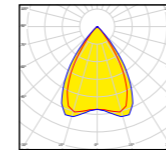

Reflector gold

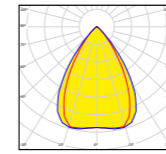

Reflector silver

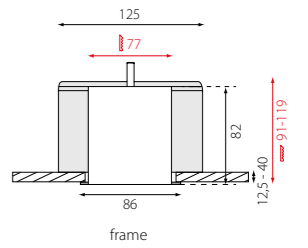
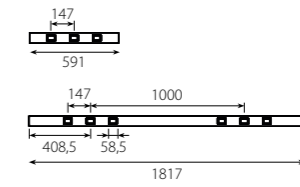

LUMINOUS FLUX (LM) / SYSTEM POWER (W)

4000K silver mate, CRI > 80	low output	high output	
591 mm	1851 lm / 17,5W	3018 lm / 32W	1,9kg
1801 mm	3702 lm / 35W	6036 lm / 65W	4,8kg

(based on DALI)

COMPARE REFLECTOR COLOUR 1801 MM, LOW OUTPUT

	low output	high output
silver matte	3702 lm	6036 lm
high-gloss gold	3060 lm	5112 lm





CUT OUT

SIZE	WIDTH	DEPTH
all lengths - 9mm	77 mm	91-119 mm

1 SIZE

591 mm	059
1817 mm	181



2 COLOUR

 silver	9006
 white	9016
 black	9005
 RAL of your choice	



3 OUTPUT

 low output	L
 high output	H

4 DIM

 non-dim	1
 DALI-dim	3

5 REFLECTOR

 silver matte*	P
 high-gloss gold*	G

* UGR-optimised, configure online

P3TE 1-2 C1840 3 4 5

P3TE059-9016C1840H1G frame, 591 mm, white, IP20, direct, CRI > 80, 4000K, high output, non-dim, reflector gold (order sample)

► [Configure online on KATALOG.PLANLICHT.COM](#)



Down to UGR ≤ 19 | up to 106 lm/W | IEC 62471: Blue light hazard: RG 0 | DALI switchDIM

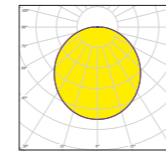

satiné

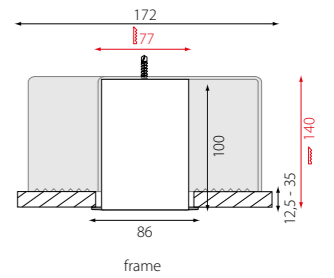

LUMINOUS FLUX (LM) / SYSTEM POWER (W)

4000K satiné	low output CRI > 80	high output CRI > 80	dynamic white CRI > 90	
614 mm	787 lm / 10W	1422 lm / 17,5W	1076 lm / 20W	2,3 kg
894 mm	1205 lm / 15,5W	2177 lm / 26W	1648 lm / 27W	3,1 kg
1174 mm	1621 lm / 20W	2927 lm / 34W	2216 lm / 35W	4,0 kg
1454 mm	2034 lm / 24W	3672 lm / 43W	2779 lm / 43W	5,0 kg
1734 mm	2444 lm / 28W	4411 lm / 50W	3339 lm / 51W	5,8 kg
2294 mm	3255 lm / 36W	5874 lm / 66W	4446 lm / 68W	7,6 kg
2854 mm	4055 lm / 48W	7315 lm / 85W	5537 lm / 87W	10,5 kg
3414 mm	4842 lm / 56W	8734 lm / 100W	6612 lm / 102W	12,2 kg
4534 mm	6381 lm / 73W	11510 lm / 133W	8713 lm / 135W	15,7 kg

(based on optic S, DALI)

COMPARE LIGHT COLOUR 1440 MM, SATINÉ

low output CRI > 80		
4000 K, CRI > 80	2034 lm	-1,3%
4000 K, CRI > 90	2007 lm	
3000 K, CRI > 80	1962 lm	-3,1%
3000 K, CRI > 90	1901 lm	

CUT OUT

SIZE	WIDTH	↑ DEPTH
all lengths - 10 mm	77 mm	140 mm

1 SIZE

614 mm	061
894 mm	089
1174 mm	117
1454 mm	145
1734 mm	173
2294 mm	229
2854 mm	285
3414 mm	341
4534 mm	453

2 COLOUR

	silver	9006
	white	9016
	black	9005
	RAL of your choice	

3 LED

	3000 K, CRI > 80	830
	4000 K, CRI > 80	840
	3000 K, CRI > 90	930
	4000 K, CRI > 90	940
	2700 - 6500 K dynamic white, CRI > 90	HCL

4 OUTPUT / CONTROL

	low output non-dim	L1
	low output DALI	L3
	high output DALI	H3
	dynamic white	X3

P58 1-2 Q1 3 4 5

P58E061 - 9016Q1840H3S frame, 614 mm, white, IP54, direct, CRI > 80, 4000 K, high output DALI, satiné (order sample)

► [Configure online on KATALOG.PLANLICHT.COM](#)



up to 90 lm/W | up to 2626 lm/m | IEC 62471: Blue light hazard: RG 0 | DALI switchDIM

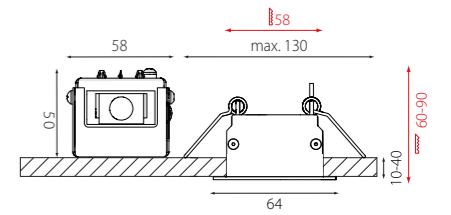
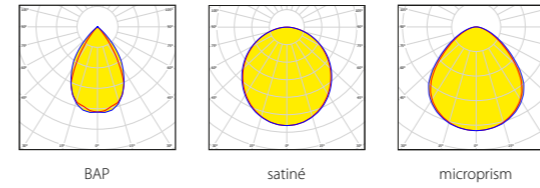
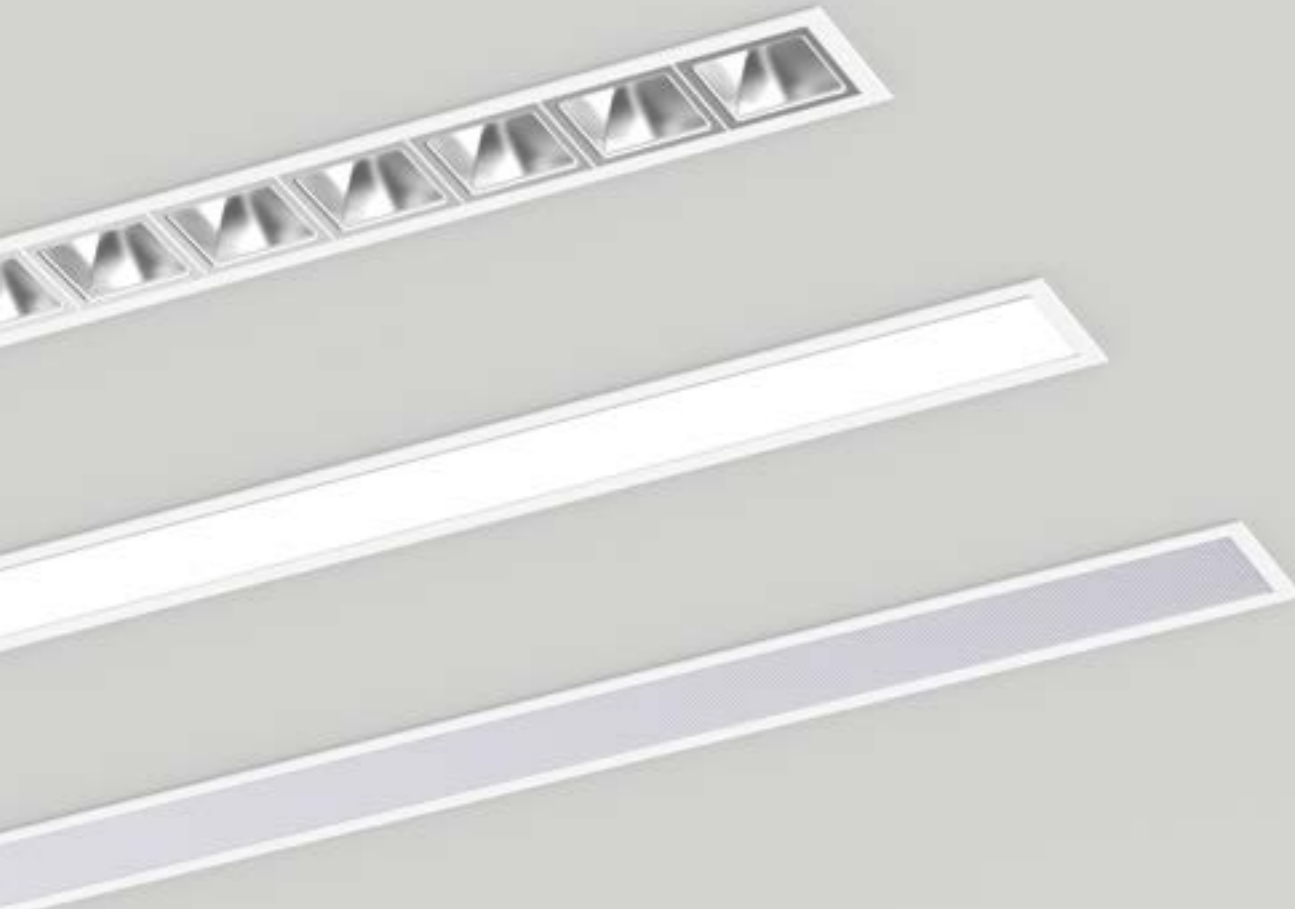

CUT OUT

SIZE	WIDTH	DEPTH
all lengths - 6 mm	58 mm	60 - 90 mm

LUMINOUS FLUX (LM)/SYSTEM POWER (W)

	low output CRI > 80	high output CRI > 80	dynamic white CRI > 90	WEIGHT
576 mm	1042 lm / 10W	2036 lm / 20W	1615 lm / 21W	2,0 kg
1136 mm	2083 lm / 19W	4067 lm / 38W	3227 lm / 39W	2,8 kg
1416 mm	2603 lm / 23W	5083 lm / 47W	4033 lm / 48W	3,1 kg
1696 mm	3123 lm / 27W	6099 lm / 56W	4839 lm / 57W	3,4 kg
2256 mm	4163 lm / 37W	8131 lm / 73W	6451 lm / 74W	4,0 kg

(based on DALI)

COMPARE COVER 1416 MM, 4000 K, CRI > 80

	low output CRI > 80	high output CRI > 80	dynamic white CRI > 90
satiné	2000 lm / 16W	3474 lm / 30W	2630 lm / 29W
microprism	1580 lm / 16W	2745 lm / 30W	2078 lm / 29W
high-gloss silver	3005 lm / 23W	5869 lm / 47W	4656 lm / 48W
silver matte	2603 lm / 23W	5083 lm / 47W	4033 lm / 48W
high-gloss gold	2748 lm / 23W	5367 lm / 47W	4258 lm / 48W
high-gloss copper	2731 lm / 23W	5334 lm / 47W	4232 lm / 48W
BAP white	2827 lm / 23W	5521 lm / 47W	4380 lm / 48W
BAP black	1495 lm / 23W	2920 lm / 47W	2316 lm / 48W
glaring gold	1749 lm / 23W	3416 lm / 47W	2710 lm / 48W
capital copper	1589 lm / 23W	3104 lm / 47W	2463 lm / 48W
gunnery grey	1767 lm / 23W	3451 lm / 47W	2738 lm / 48W
high-gloss black chrome	2260 lm / 23W	4415 lm / 47W	3502 lm / 48W

COMPARE LIGHT COLOUR 1416 MM, BAP SILVER MATTE

4000 K, CRI > 80	5083 lm	
4000 K, CRI > 90	5313 lm	+ 4,5 %
3000 K, CRI > 80	4850 lm	
3000 K, CRI > 90	5068 lm	+ 4,5 %

1 SIZE

no Sensor	with Sensor
576 mm 057	
1136 mm 113	1206 mm 120
1416 mm 141	1486 mm 148
1696 mm 169	
2256 mm 225	

2 COLOUR

silver	9006
white	9016
black	9005
RAL of your choice	

3 LED

3000 K, CRI > 80	830
4000 K, CRI > 80	840
3000 K, CRI > 90	930
4000 K, CRI > 90	940
2700 - 6500 K dynamic white, CRI > 90	HCL

4 OUTPUT / CONTROL

no Sensor	with Sensor
low output non-dim L1	
low output DALI L3	L7
high output DALI H3	H7
dynamic white X3	

Dynamic white with Sensor on request (X7)

5 OPTIC

satiné	S	BAP white (RAL 9016)*	W
microprism*	M	BAP black (RAL 9005)*	N
BAP high-gloss silver*	B	BAP glaring gold*	D
BAP silver matte*	P	BAP capital copper*	R
BAP high-gloss gold*	G	BAP gunnery grey*	Y
BAP high-gloss copper*	K	BAP high-gloss black chrome*	Z

* UGR-optimised, configure online

T65E 1-2 C1 3 4 5

T65E057-9016C1840H3B frame, 576 mm, white, IP20, direct, 4000 K, CRI > 80, high output DALI, BAP high-gloss silver (order sample)

► [Configure online on KATALOG.PLANLICHT.COM](#)

5 BAP LOUVRE COLOURS



OPTIONAL ACCESSORIES

T65-DVS1	Loop-connection-set
T65-ENDS-9005	End cap - set black
T65-ENDS-9006	End cap - set silver
T65-ENDS-9016	End cap - set white

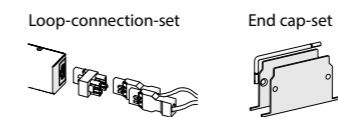

PROFILE VIEW



Down to UGR ≤ 16 | up to 149 lm / W | up to 4183 lm / m | IEC 62471: Blue light hazard: RG 0 | DALI switchDIM

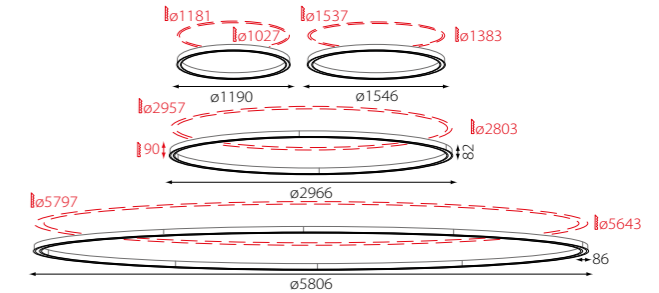
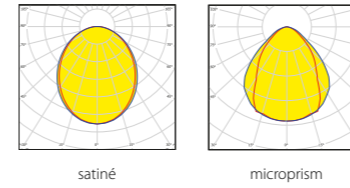

LUMINOUS FLUX (LM) / SYSTEM POWER (W)

4000K satiné	low output CRI > 80	high output CRI > 80	dynamic white CRI > 90	
ø 1190 mm	4901 lm / 43 W	8761 lm / 81 W	6632 lm / 83 W	7 kg
ø 1546 mm	6535 lm / 57 W	11681 lm / 111 W	8843 lm / 109 W	8,9 kg
ø 2966 mm	13070 lm / 118 W	23363 lm / 222 W	17686 lm / 219 W	16,2 kg
ø 5806 mm	26140 lm / 236 W	46725 lm / 445 W	35371 lm / 437 W	31,9 kg

COMPARE COVER Ø 1546 MM, 4000K, CRI > 80

	low output CRI > 80	high output CRI > 80	dynamic white CRI > 90
satiné	6535 lm	11681 lm	8217 lm
microprism*	7031 lm	12567 lm	9063 lm

COMPARE LIGHT COLOUR Ø 1546 MM, SATINÉ

4000 K, CRI > 80	6535 lm	-1,3%
4000 K, CRI > 90	6448 lm	
3000 K, CRI > 80	6302 lm	-3,1%
3000 K, CRI > 90	6106 lm	

CUT OUT

SIZE	ø DIAMETER	↑ DEPTH
ø 1190 mm	ø 1181 / 1027 mm	90 mm
ø 1546 mm	ø 1537 / 1383 mm	90 mm
ø 2966 mm	ø 2957 / 2803 mm	90 mm
ø 5806 mm	ø 5797 / 5643 mm	90 mm

*Der angegebene Lichtstrom bezieht sich auf die Leuchte mit klarer mikroprismatischer Abdeckung. Die Leuchte wird mit satinierter Folie zur Erhöhung der Homogenität geliefert (-28,2% Lichtstrom).
 The indicated luminous flux corresponds to the luminaire with a clear microprismatic diffuser. The luminaire is delivered with a satinized foil for increased homogeneity (-28,2% luminous flux).
 Le flux lumineux indiqué correspond au luminaire avec diffuseur microprismatique transparent. Le luminaire est livré avec un film satiné pour optimiser l'homogénéité (-28,2 % sur le flux lumineux).

1 SIZE

ø 1190 mm	119
ø 1546 mm	154
ø 2966 mm	296
ø 5806 mm	580

2 COLOUR

	silver	9006
	white	9016
	black	9005
	RAL of your choice	

3 LED

	3000 K, CRI > 80	830
	4000 K, CRI > 80	840
	3000 K, CRI > 90	930
	4000 K, CRI > 90	940
	2700 - 6500 K dynamic white, CRI > 90	HCL

4 OUTPUT / CONTROL

	low output non-dim	L1
	low output DALI	L3
	high output DALI	H3
	dynamic white	X3

5 OPTIC

	satiné	S
	microprism*	M

*UGR-optimised, configure online

R33E 1-2 E1 3 4 5

R33E119-9016E1840H3S frame, ø 1190 mm, white, IP 40, direct, 4000 K, CRI > 80, high output DALI, satiné (order sample)

► Configure online on KATALOG.PLANLICHT.COM

ALSO AVAILABLE AS A SYSTEM 390



Down to UGR ≤ 19 | up to 123 lm/W | IEC 62471: Blue light hazard: RG 0 | DALI switchDIM

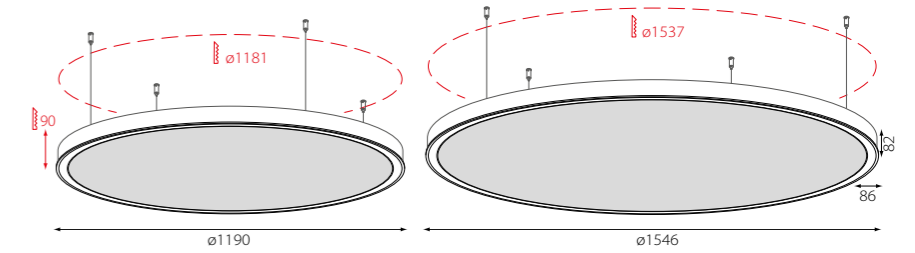
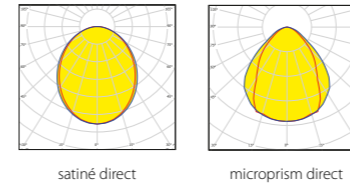

LUMINOUS FLUX (LM) / SYSTEM POWER (W)

4000K satiné	low output CRI > 80	high output CRI > 80	dynamic white CRI > 90	
ø 1190 mm	4901 lm / 43 W	8761 lm / 81 W	6632 lm / 83 W	20,4 kg
ø 1546 mm	6535 lm / 57 W	11681 lm / 111 W	8843 lm / 109 W	31,7 kg

COMPARE COVER Ø 1546 MM, 4000K, CRI > 80

	low output CRI > 80	high output CRI > 80	dynamic white CRI > 90
satiné	6535 lm	11681 lm	8217 lm
microprism*	7031 lm	12567 lm	9063 lm

COMPARE LIGHT COLOUR Ø 1546 MM, SATINÉ

4000 K, CRI > 80	6535 lm	-1,3%
4000 K, CRI > 90	6448 lm	
3000 K, CRI > 80	6302 lm	-3,1%
3000 K, CRI > 90	6106 lm	

CUT OUT

SIZE	ø DIAMETER	↑ DEPTH
ø 1190 mm	ø 1181 mm	90 mm
ø 1546 mm	ø 1537 mm	90 mm









*Der angegebene Lichtstrom bezieht sich auf die Leuchte mit klarer mikroprismatischer Abdeckung. Die Leuchte wird mit satiniertes Folie zur Erhöhung der Homogenität geliefert (-28,2% Lichtstrom).
The indicated luminous flux corresponds to the luminaire with a clear microprismatic diffuser. The luminaire is delivered with a satinized foil for increased homogeneity (-28,2% luminous flux).
Le flux lumineux indiqué correspond au luminaire avec diffuseur microprismatique transparent. Le luminaire est livré avec un film satiné pour optimiser l'homogénéité (-28,2 % sur le flux lumineux).

1 SIZE

ø 1190 mm
ø 1546 mm





119
154

2 ACOUSTIC MODULE





	QUIET.FELT standard anthracite melange	QA
	QUIET.FELT standard pebble	QP
	QUIET.FELT standard lime	QL
	QUIET.FELT extra+ black *	QB
	QUIET.FELT extra+ fire *	QF
	QUIET.FELT extra+ light grey melange *	QG
	QUIET.FELT extra+ chocolate *	QC
	Organoid® Mous *	QM
	Organoid® Wollä *	QW
	Organoid® Wildspitze *	QH

* on request





3 COLOUR

	silver	SI
	white	WS
	black	SW
	RAL of your choice	



4 LED

	3000 K, CRI > 80	830
	4000 K, CRI > 80	840
	3000 K, CRI > 90	930
	4000 K, CRI > 90	940
	2700 - 6500 K dynamic white, CRI > 90	HCL

5 OUTPUT / CONTROL

	low output non-dim	L1
	low output DALI	L3
	high output DALI	H3
	dynamic white	X3

6 OPTIC

	satiné	S
	microprism*	M

* UGR-optimised, configure online

R33E 1-2-3-E1-4-5-6

R33E119-QPWS1840H3S frame, ø 1190 mm, acoustic module, standard pebble, housing white, 4000 K, CRI > 80, high output DALI, satiné (order sample)

► [Configure online on KATALOG.PLANLICHT.COM](#)



Down to UGR ≤ 19 | up to 123 lm/W | IEC 62471: Blue light hazard: RG 0 | DALI switchDIM

ophelia frame

Einbauleuchte
Recessed luminaire
Luminaire encastré

OPHELIA FRAME | RECESSED

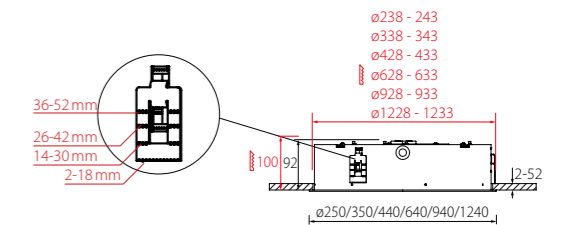
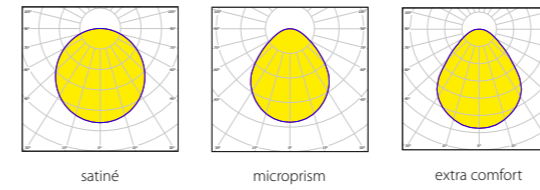

LUMINOUS FLUX (LM) / SYSTEM POWER (W)

4000K satiné, white	low output CRI > 80	high output CRI > 80	very high output CRI > 80	dynamic white CRI > 90	⚠
ø 250 mm	683 lm / 6,4W	1360 lm / 12,5W	1904 lm / 17,5W	1054 lm / 16W	2,0 kg
ø 350 mm	861 lm / 7,4W	1951 lm / 15W	2381 lm / 18,5W	1512 lm / 15W	3,0 kg
ø 440 mm	1484 lm / 11,5W	2893 lm / 22W	3590 lm / 28W	2242 lm / 22W	4,4 kg
ø 640 mm	3200 lm / 22W	5781 lm / 40W	7231 lm / 51W	4277 lm / 39W	8,0 kg
ø 940 mm	6895 lm / 51W	13586 lm / 97W	17309 lm / 131W	10529 lm / 99W	17,5 kg
ø 1240 mm	13571 lm / 101W	26740 lm / 188W	33352 lm / 231W	17125 lm / 155W	28,1 kg

(based on DALI)

COMPARE COVER Ø 440 MM, 4000 K, CRI > 80

	low output CRI > 80	high output CRI > 80	very high output CRI > 80	dynamic white CRI > 90
satiné	1484 lm	2893 lm	3590 lm	2242 lm
microprism	1428 lm	2784 lm	3455 lm	2158 lm
extra comfort	1813 lm	3535 lm	4387 lm	2740 lm

OPTIONAL ACCESSORY REFLECTOR AS LIGHT BOOSTER

SIZE	REFLECTOR	Efficiency increase	
		satiné, white housing	satiné, black housing
ø 250 mm	F53E-BST-025	11,3%	60,3%
ø 350 mm	F53E-BST-035	7,7%	48,5%
ø 440 mm	F53E-BST-044	4,6%	38,6%
ø 640 mm	F53E-BST-064	1,8%	18,6%

CUT OUT

SIZE	ø DIAMETER	↑ DEPTH
ø 250 mm	ø 238 - 243 mm	100 mm
ø 350 mm	ø 338 - 343 mm	100 mm
ø 440 mm	ø 428 - 433 mm	100 mm
ø 640 mm	ø 628 - 633 mm	100 mm
ø 940 mm	ø 928 - 933 mm	100 mm
ø 1240 mm	ø 1228 - 1233 mm	100 mm

Die angegebenen Lichtstromwerte (lm) beziehen sich auf Leuchten mit einem weißen Gehäuse (RAL 9016). Je nach Gehäusefarbe und Durchmesser reduzieren sich diese entsprechend.
 All figures of luminous flux (lm) are for fixtures with white housing (RAL 9016). Depending on the housing colour and diameter, the luminous flux is reduced accordingly.

Les valeurs de flux lumineux (lm) indiquées se réfèrent aux luminaires à corps blanc (RAL 9016). En fonction de la couleur du corps et du diamètre, celles-ci sont réduites en conséquence.

Deckenstärke | Ceiling thickness | Épaisseur du plafond: 2 mm - 52 mm

1 SIZE

ø 250 mm	025
ø 350 mm	035
ø 440 mm	044
ø 640 mm	064
ø 940 mm	094
ø 1240 mm	124

2 COLOUR

	black	9005
	silver	9006
	white	9016
	RAL of your choice	

3 LED

	3000 K, CRI > 80	830
	4000 K, CRI > 80	840
	3000 K, CRI > 90	930
	4000 K, CRI > 90	940
	2700 - 6500 K dynamic white, CRI > 90	HCL

4 OUTPUT / CONTROL

	low output non-dim	L1
	low output DALI	L3
	high output DALI	H3
	very high output DALI	V3
	dynamic white	X3

5 OPTIC

	satiné	S
	microprism*	M
	extra comfort*	E NEW

* UGR-optimised, configure online

F53E 1-2 C1 3 4 5

F53E044-9016C1840H3S frame, ø 440 mm, white, IP20, direct, 4000 K, CRI > 80, high output DALI, satiné (order sample)

► [Configure online on KATALOG.PLANLICHT.COM](#)



Down to UGR ≤ 19 | up to 164 lm/W | IEC 62471: Blue light hazard: RG 0 | DALI switchDIM

ophelia frameless

Einbauleuchte
Recessed luminaire
Luminaire encastré

OPHELIA FRAMELESS | RECESSED

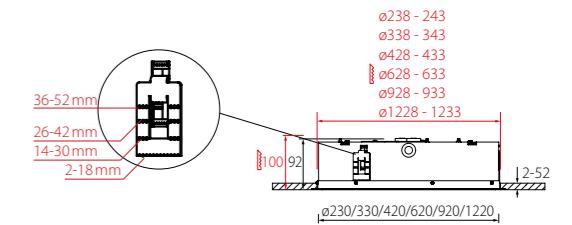
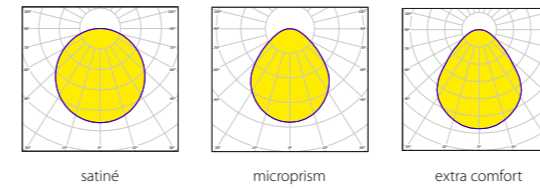

LUMINOUS FLUX (LM) / SYSTEM POWER (W)

4000K satiné, white	low output CRI > 80	high output CRI > 80	very high output CRI > 80	dynamic white CRI > 90	
ø 230 mm	683 lm / 6,4W	1360 lm / 12,5W	1904 lm / 17,5W	1054 lm / 16W	1,8 kg
ø 330 mm	861 lm / 7,4W	1951 lm / 15W	2381 lm / 18,5W	1512 lm / 15W	2,9 kg
ø 420 mm	1484 lm / 11,5W	2893 lm / 22W	3590 lm / 28W	2242 lm / 22W	4,2 kg
ø 620 mm	3200 lm / 22W	5781 lm / 40W	7231 lm / 51W	4277 lm / 39W	7,7 kg
ø 920 mm	6895 lm / 51W	13586 lm / 97W	17309 lm / 131W	10529 lm / 99W	17,1 kg
ø 1220 mm	13571 lm / 101W	26740 lm / 188W	33352 lm / 231W	17125 lm / 155W	27,5 kg

(based on DALI)

COMPARE COVER Ø 440 MM, 4000 K, CRI > 80

	low output CRI > 80	high output CRI > 80	very high output CRI > 80	dynamic white CRI > 90
satiné	1484 lm	2893 lm	3590 lm	2242 lm
microprism	1428 lm	2784 lm	3455 lm	2158 lm
extra comfort	1813 lm	3535 lm	4387 lm	2740 lm

OPTIONAL ACCESSORY REFLECTOR AS LIGHT BOOSTER

Efficiency increase		
satiné		
SIZE	REFLECTOR	Efficiency increase
ø 230 mm	F53E-BST-025	11,3%
ø 330 mm	F53E-BST-035	7,7%
ø 420 mm	F53E-BST-044	4,6%
ø 620 mm	F53E-BST-064	1,8%

CUT OUT

SIZE	ø DIAMETER	↑ DEPTH
ø 230 mm	ø 238 - 243 mm	100 mm
ø 330 mm	ø 338 - 343 mm	100 mm
ø 420 mm	ø 428 - 433 mm	100 mm
ø 620 mm	ø 628 - 633 mm	100 mm
ø 920 mm	ø 928 - 933 mm	100 mm
ø 1220 mm	ø 1228 - 1233 mm	100 mm

Die angegebenen Lichtstromwerte (lm) beziehen sich auf Leuchten mit einem weißen Gehäuse (RAL 9016). Je nach Gehäusefarbe und Durchmesser reduzieren sich diese entsprechend.
 All figures of luminous flux (lm) are for fixtures with white housing (RAL 9016). Depending on the housing colour and diameter, the luminous flux is reduced accordingly.
 Les valeurs de flux lumineux (lm) indiquées se réfèrent aux luminaires à corps blanc (RAL 9016). En fonction de la couleur du corps et du diamètre, celles-ci sont réduites en conséquence.

Deckenstärke | Ceiling thickness | Épaisseur du plafond : 2 mm - 52 mm

1 SIZE

ø 230 mm	023
ø 330 mm	033
ø 420 mm	042
ø 620 mm	062
ø 920 mm	092
ø 1220 mm	122

2 LED

	3000 K, CRI > 80	830
	4000 K, CRI > 80	840
	3000 K, CRI > 90	930
	4000 K, CRI > 90	940
	2700 - 6500 K dynamic white, CRI > 90	HCL

3 OUTPUT / CONTROL

	low output non-dim	L1
	low output DALI	L3
	high output DALI	H3
	very high output DALI	V3
	dynamic white	X3

4 OPTIC

	satiné	S
	microprism*	M
	extra comfort*	E NEW

* UGR-optimised, configure online

F53F 1-ALUBC1 2 3 4

F53F042 - ALUBC1840H3S frameless, ø 420 mm, IP 20, direct, 4000 K, CRI > 80, high output DALI, satiné (order sample)

► [Configure online on KATALOG.PLANLICHT.COM](#)



Down to UGR ≤ 19 | up to 164 lm/W | IEC 62471: Blue light hazard: RG 0 | DALI switchDIM

liha frame

Einbauleuchte
Recessed luminaire
Luminaire encastré

LIHA FRAME | RECESSED

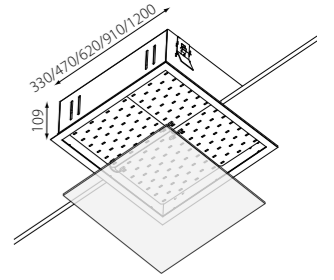
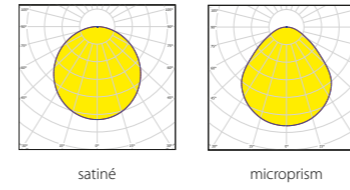

LUMINOUS FLUX (LM) / SYSTEM POWER (W)

4000K satiné, white	low output CRI > 80	high output CRI > 80	dynamic white CRI > 90	
330 x 330 mm	1197 lm / 10,5 W	1934 lm / 20 W	1445 lm / 20 W	4,3 kg
470 x 470 mm	2363 lm / 22 W	3663 lm / 34 W	2734 lm / 34 W (CRI > 80)	6,6 kg
620 x 620 mm	4104 lm / 34 W	7898 lm / 66 W	5806 lm / 65 W	10,7 kg
910 x 910 mm	8124 lm / 62 W	15647 lm / 122 W	11653 lm / 122 W	22,0 kg
1200 x 1200 mm	13348 lm / 105 W	26710 lm / 219 W	20295 lm / 219 W	36,4 kg

COMPARE COVER 470 x 470 MM, 4000 K, CRI > 80

	satiné	microprism
470 x 470 mm	2362 lm	2283 lm
620 x 620 mm	3663 lm	2833 lm
910 x 910 mm	2734 lm	2646 lm

CUT OUT

SIZE	DIAMETER	DEPTH
330 x 330 mm	320 x 320 mm	115 mm
470 x 470 mm	460 x 460 mm	115 mm
620 x 620 mm	610 x 610 mm	115 mm
910 x 910 mm	900 x 900 mm	115 mm
1200 x 1200 mm	1190 x 1190 mm	115 mm

Die angegebenen Lichtstromwerte (lm) beziehen sich auf Leuchten mit einem weißen Gehäuse (RAL 9016). Je nach Gehäusefarbe und Durchmesser reduzieren sich diese entsprechend.
All figures of luminous flux (lm) are for fixtures with white housing (RAL 9016). Depending on the housing colour and diameter, the luminous flux is reduced accordingly.
Les valeurs de flux lumineux (lm) indiquées se réfèrent aux luminaires à corps blanc (RAL 9016). En fonction de la couleur du corps et du diamètre, celles-ci sont réduites en conséquence.





Deckenstärke | Ceiling thickness | Épaisseur du plafond: 2 mm - 30 mm

1 SIZE

330 x 330 mm
470 x 470 mm
620 x 620 mm
910 x 910 mm
1200 x 1200 mm





03Q
04Q
06Q
09Q
12Q

2 COLOUR





 silver
 white
 black
 RAL of your choice

9006
9016
9005

3 LED



 3000 K, CRI > 80 **830**
 4000 K, CRI > 80 **840**
 3000 K, CRI > 90 **930**
 4000 K, CRI > 90 **940**
 2700 - 6500 K dynamic white, CRI > 90 **HCL**
(SIZE 470 x 470 mm: CRI > 80)

4 OUTPUT / CONTROL

 low output non-dim
 low output DALI
 high output DALI
 dynamic white

L1
L3
H3
X3

5 OPTIC

 satiné **S**
 microprism* **M**
*UGR-optimised, configure online

F51E 1-2 C1 3 4 5

F51E04Q-9016C1840H3S frame, 470 x 470 mm, white, IP 20, direct, CRI > 80, 4000 K, high output DALI, satiné (order sample)

► [Configure online on KATALOG.PLANLICHT.COM](#)



Down to UGR ≤ 19 | up to 131 lm/W | IEC 62471: Blue light hazard: RG 0 | DALI switchDIM

liha frameless

Einbauleuchte
Recessed luminaire
Luminaire encastré

LIHA FRAMELESS | RECESSED

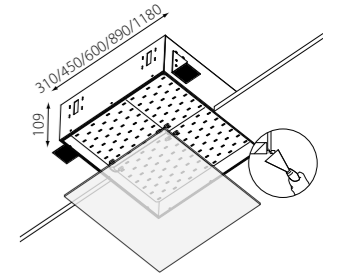
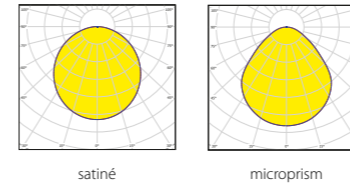

LUMINOUS FLUX (LM) / SYSTEM POWER (W)

4000K satiné, white	low output CRI > 80	high output CRI > 80	dynamic white CRI > 90	
310x310 mm	1173 lm / 10,5 W	2249 lm / 20 W	1679 lm / 20 W	3,3 kg
450x450 mm	2611 lm / 22 W	4048 lm / 34 W	3021 lm / 34 W (CRI > 80)	5,3 kg
600x600 mm	4104 lm / 34 W	7898 lm / 66 W	5806 lm / 65 W	9,3 kg
890x890 mm	8124 lm / 62 W	15647 lm / 122 W	11653 lm / 122 W	18,5 kg
1180x1180 mm	13348 lm / 105 W	26710 lm / 219 W	20295 lm / 219 W	31,7 kg

COMPARE COVER 450x450 MM, 4000 K, CRI > 80

	satiné	microprism*
low output CRI > 80	2611 lm	2523 lm
high output CRI > 80	4048 lm	3918 lm
dynamic white CRI > 90	3021 lm	2923 lm

CUT OUT

SIZE	□ DIAMETER	↑ DEPTH
310x310 mm	□ 317x317 mm	115 mm
450x450 mm	□ 457x457 mm	115 mm
600x600 mm	□ 607x607 mm	115 mm
890x890 mm	□ 897x897 mm	115 mm
1180x1180 mm	□ 1187x1187 mm	115 mm

Die angegebenen Lichtstromwerte (lm) beziehen sich auf Leuchten mit einem weißen Gehäuse (RAL 9016). Je nach Gehäusefarbe und Durchmesser reduzieren sich diese entsprechend.
All figures of luminous flux (lm) are for fixtures with white housing (RAL 9016). Depending on the housing colour and diameter, the luminous flux is reduced accordingly.
Les valeurs de flux lumineux (lm) indiquées se réfèrent aux luminaires à corps blanc (RAL 9016). En fonction de la couleur du corps et du diamètre, celles-ci sont réduites en conséquence.

Deckenstärke | Ceiling thickness | Épaisseur du plafond: 2 mm - 30 mm

1 SIZE

310x310 mm
450x450 mm
600x600 mm
890x890 mm
1180x1180 mm

2 LED

03Q 3000 K, CRI > 80
04Q 4000 K, CRI > 80
06Q 3000 K, CRI > 90
08Q 4000 K, CRI > 90
11Q 2700 - 6500 K dynamic white, CRI > 90
(SIZE 450x450 mm: CRI > 80)

3 OUTPUT/CONTROL

830 low output non-dim **L1**
840 low output DALI **L3**
930 high output DALI **H3**
940 dynamic white **X3**

4 OPTIC

satiné **S**
 microprism* **M**

* UGR-optimised, configure online

F51F **1**-9016C**1** **2** **3** **4**

F51F04Q-9016C1840H3S frameless, white, IP 20, direct, CRI > 80, 450x450 mm, 4000 K, high output DALI, satiné (order sample)

► [Configure online on KATALOG.PLANLICHT.COM](#)



Down to UGR ≤ 19 | up to 130 lm/W | IEC 62471: Blue light hazard: RG 0 | DALI switchDIM

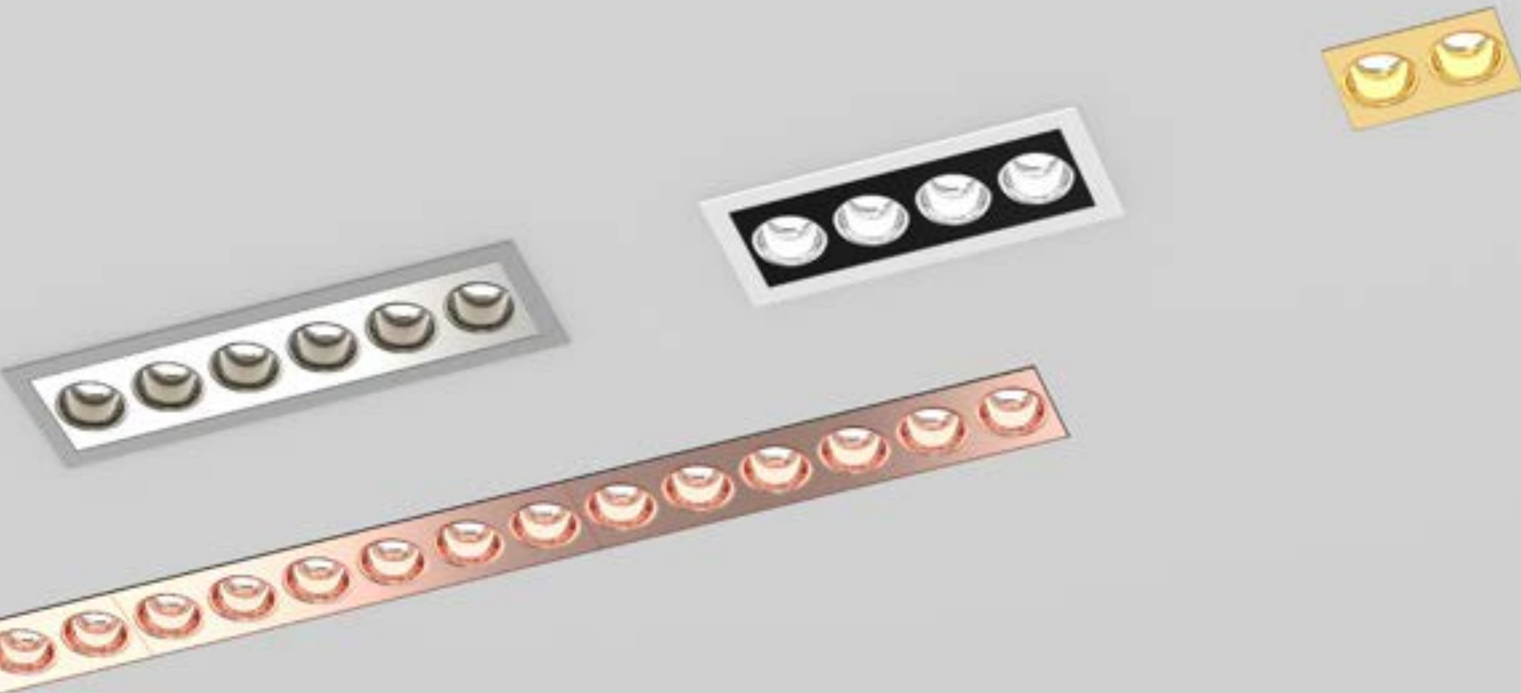

1 MOUNTING

Frame	E
Frameless	F

2 SIZE

FRAME		FRAMELESS	
2 spots - 76 mm	007	2 spots - 64 mm	006
4 spots - 136 mm	013	4 spots - 124 mm	012
6 spots - 196 mm	019	6 spots - 184 mm	018
8 spots - 256 mm	025	8 spots - 244 mm	024
12 spots - 376 mm	037	12 spots - 364 mm	036
18 spots - 556 mm	055	18 spots - 544 mm	054

3 TUBE COLOUR

high-gloss silver	B	black (RAL 9005)	N
silver matte	P	glaring gold	D
high-gloss gold	G	capital copper	R
high-gloss copper	K	gunnery grey	Y
white (RAL 9016)	W	high-gloss black chrome	Z

NEW

4 MASK COLOUR

high-gloss silver	B	black (RAL 9005)	N
silver matte	P	glaring gold	D
high-gloss gold	G	capital copper	R
high-gloss copper	K	gunnery grey	Y
white (RAL 9016)	W	high-gloss black chrome	Z

NEW

5 HOUSING COLOUR

silver	SI
white	WS
black	SW
RAL of your choice	🔧

6 LED

2700 K, CRI > 90	927
3000 K, CRI > 90	930
4000 K, CRI > 90	940
2700-6500 K, dynamic white, CRI > 90	HCL

7 OUTPUT / CONTROL

low output non-dim	L1
high output non-dim	H1
high output DALI	H3
dynamic white	X3

8 BEAM

15°	1
30°	3
45°	4
asymmetric / oval	A

S44 1 2 3 4 5 C1 6 7 8

S44E019-RDSWC1927H33 Recessed frame, 6 spots, lens tube capital copper, mask glaring gold, housing black, IP 20, direct, 2700 K, CRI > 90, high output DALI, 30° (order sample)

► Configure online on KATALOG.PLANLICHT.COM

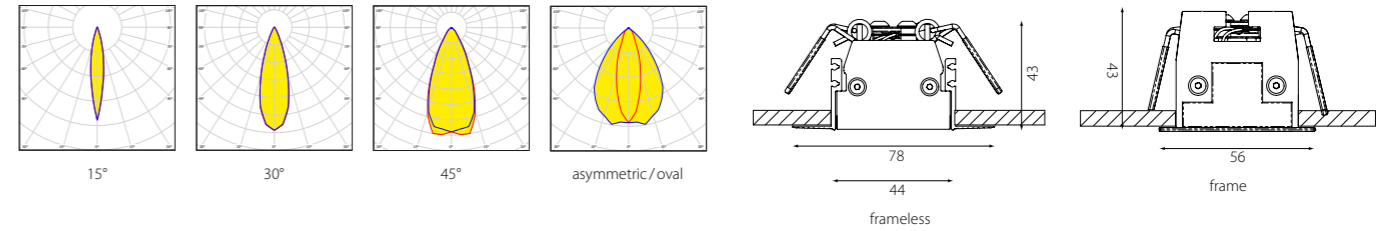

LUMINOUS FLUX (LM) anto+ / lens tube silver matte

	low output				high output				dynamic white			
	15°	30°	45°	asym.	15°	30°	45°	asym.	15°	30°	45°	asym.
2700 K												
2 spots	193 lm	181 lm	151 lm	155 lm	336 lm	313 lm	264 lm	276 lm	-	-	-	-
4 spots	339 lm	326 lm	294 lm	305 lm	656 lm	607 lm	510 lm	545 lm	291 lm	280 lm	253 lm	262 lm
6 spots	560 lm	507 lm	419 lm	438 lm	969 lm	874 lm	716 lm	757 lm	482 lm	436 lm	360 lm	377 lm
8 spots	756 lm	712 lm	593 lm	609 lm	1357 lm	1266 lm	1066 lm	1115 lm	658 lm	612 lm	526 lm	530 lm
12 spots	1123 lm	1057 lm	881 lm	904 lm	1989 lm	1857 lm	1564 lm	1634 lm	966 lm	909 lm	757 lm	777 lm
18 spots	1674 lm	1576 lm	1312 lm	1346 lm	2952 lm	2756 lm	2319 lm	2424 lm	1423 lm	1340 lm	1115 lm	1144 lm
3000 K												
2 spots	197 lm	185 lm	154 lm	158 lm	343 lm	320 lm	269 lm	282 lm				
4 spots	346 lm	333 lm	300 lm	311 lm	669 lm	619 lm	520 lm	556 lm				
6 spots	552 lm	524 lm	427 lm	447 lm	949 lm	893 lm	734 lm	763 lm				
8 spots	772 lm	727 lm	605 lm	621 lm	1384 lm	1292 lm	1088 lm	1137 lm				
12 spots	1147 lm	1079 lm	899 lm	922 lm	2030 lm	1895 lm	1595 lm	1667 lm				
18 spots	1763 lm	1686 lm	1404 lm	1440 lm	3062 lm	2927 lm	2463 lm	2574 lm				
4000 K												
2 spots	205 lm	193 lm	161 lm	165 lm	357 lm	333 lm	280 lm	293 lm				
4 spots	360 lm	346 lm	312 lm	324 lm	697 lm	645 lm	542 lm	580 lm				
6 spots	575 lm	544 lm	446 lm	467 lm	993 lm	929 lm	764 lm	805 lm				
8 spots	805 lm	757 lm	630 lm	647 lm	1442 lm	1346 lm	1133 lm	1184 lm				
12 spots	1193 lm	1123 lm	935 lm	959 lm	2114 lm	1973 lm	1661 lm	1735 lm				
18 spots	1834 lm	1718 lm	1430 lm	1467 lm	3187 lm	3006 lm	2530 lm	2644 lm				

SYSTEM POWER (W)

	low output	high output	dynamic white
2 spots	3W	6,7W	-
4 spots	5,1W	10,5W	7W
6 spots	7,2W	13,5W	9,5W
8 spots	9,6W	18W	11,5W
12 spots	13W	26W	15,5W
18 spots	19,5W	41 W	22W

VARIATIONS ANTO+ RECESSED

	LOW OUTPUT		HIGH OUTPUT		DYNAMIC
	non-dim	DALI	non-dim	DALI	WHITE
2 spots	●	-	●	●	-
4 spots	●	-	●	●	●
6 spots	●	-	●	●	●
8 spots	●	-	●	●	●
12 spots	●	-	●	●	●
18 spots	●	-	●	●	●



Down to UGR ≤ 16 | up to 99 lm/W | IEC 62471: Blue light hazard: RG ≤ 1 | DALI

COMPARE LENS TUBES ANTO+ / RECESSED 8 SPOTS / HIGH OUTPUT DALI, DYNAMIC WHITE

lens tube	2700 K				3000 K				4000 K				dynamic white*			
	15°	30°	45°	asym.	15°	30°	45°	asym.	15°	30°	45°	asym.	15°	30°	45°	asym.
high-gloss silver	1428lm	1347lm	1240lm	1327lm	1457lm	1375lm	1265lm	1354lm	1518lm	1432lm	1317lm	1409lm	693lm	674lm	613lm	623lm
silver matte	1357lm	1266lm	1066lm	1115lm	1384lm	1292lm	1088lm	1137lm	1442lm	1346lm	1133lm	1184lm	658lm	612lm	526lm	530lm
high-gloss gold	1428lm	1347lm	1240lm	1327lm	1457lm	1375lm	1265lm	1354lm	1518lm	1432lm	1317lm	1409lm	693lm	662lm	612lm	623lm
high gloss copper	1392lm	1313lm	1215lm	1267lm	1421lm	1340lm	1240lm	1393lm	1480lm	1396lm	1290lm	1346lm	679lm	658lm	600lm	592lm
white (RAL9016)	1392lm	1313lm	1141lm	1201lm	1421lm	1340lm	1164lm	1225lm	1480lm	1396lm	1212lm	1275lm	679lm	656lm	570lm	573lm
black (RAL9005)	1271lm	1179lm	918lm	916lm	1297lm	1203lm	936lm	934lm	1351lm	1253lm	974lm	972lm	623lm	574lm	447lm	442lm
glaring gold	1299lm	1212lm	973lm	1009lm	1326lm	1237lm	993lm	1029lm	1381lm	1289lm	1034lm	1071lm	633lm	594lm	484lm	479lm
capital copper	1299lm	1212lm	942lm	975lm	1326lm	1237lm	961lm	995lm	1381lm	1289lm	1001lm	1036lm	626lm	582lm	469lm	467lm
gunnery grey	1299lm	1212lm	973lm	1009lm	1326lm	1237lm	993lm	1029lm	1381lm	1289lm	1034lm	1071lm	633lm	598lm	484lm	479lm
high-gloss black chrome	1273lm	1201lm	1105lm	1183lm	1299lm	1226lm	1128lm	1207lm	1353lm	1276lm	1174lm	1256lm	618lm	601lm	546lm	555lm

* dynamic white lumens = 2700K, Lumens 6500K ca. +11%

OPTIONAL ACCESSORY

S44-F-SET-MONT

- anto+ Dis-/assembly kit **frameless** (3 parts)
- anto+ De-/Montageset **frameless** (3 Teile)
- anto+ Set de dé-/montage **sans cadre** (3 parties)
- anto+ Kit di s-/montaggio **senza cornice** (3 parti)

CUT OUT / WEIGHT (g)

	FRAME				FRAMELESS			
	FRAME	↑ DALI	↑ non-dim	↑ HCL	FRAMELESS	↑ DALI	↑ non-dim	↑ HCL
2 spots	70x49mm	X+160mm/290g	X+55mm/180g		73x52mm	X+160mm/340g	X+70mm/230g	
4 spots	130x49mm	X+90mm/360g	X+55mm/260g	X+191mm/510g	133x52mm	X+90mm/440g	X+70mm/340g	X+191mm/590g
6 spots	190x49mm	X+55mm/470g	X+55mm/440g	X+70mm/590g	193x52mm	X+70mm/570g	X+70mm/540g	X+70mm/690g
8 spots	250x49mm	X+55mm/540g	X+55mm/520g	X+70mm/660g	253x52mm	X+70mm/660g	X+70mm/640g	X+70mm/780g
12 spots	370x49mm	X+55mm/700g	X+55mm/650g	X+70mm/800g	373x52mm	X+70mm/860g	X+70mm/810g	X+70mm/960g
18 spots	550x49mm	X+70mm/940g	X+55mm/840g	X+70mm/1030g	553x52mm	X+70mm/1135g	X+70mm/1030g	X+70mm/1240g



Holiday Inn Messukeskus, Foto: Sampsa Pärnänen

NEW zenit M fixed

Einbauleuchte
Recessed luminaire
Luminaire encastré



ZENIT M | RECESSED

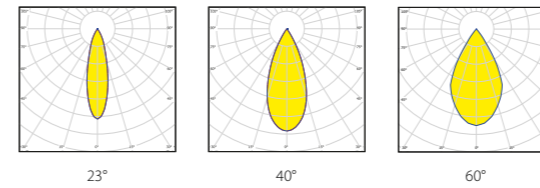

Weight (kg)
0,6 kg

CUT OUT
ø DIAMETER | ↑ DEPTH
ø 100 mm | 131 mm

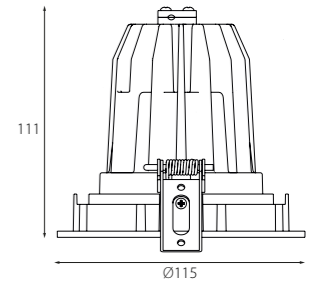

LUMINOUS FLUX (LM) / SYSTEM POWER (W) / BASED ON TUBE COLOUR BLACK MATTE (NN)

	low output (9,3 - 10W)			medium output (11 - 12W)			high output (17 - 18,5W)			very high output (22 - 24W)		
	23°	40°	60°	23°	40°	60°	23°	40°	60°	23°	40°	60°
LF830 3000 K	1112lm	1107lm	1088lm	1322lm	1316lm	1293lm	1931lm	1917lm	1884lm	2505lm	2482lm	2440lm
LF840 4000 K	1180lm	1164lm	1144lm	1404lm	1384lm	1360lm	2050lm	2023lm	1988lm	2658lm	2624lm	2579lm
LF927 2700 K	901lm	899lm	884lm	1072lm	1069lm	1051lm	1565lm	1565lm	1538lm	2029lm	2018lm	1983lm
LF930 3000 K	944lm	952lm	936lm	1122lm	1130lm	1111lm	1629lm	1643lm	1615lm	2102lm	2120lm	2084lm
LF935 3500 K	967lm	974lm	957lm	1151lm	1159lm	1139lm	1687lm	1696lm	1667lm	2196lm	2203lm	2165lm
LF940 4000 K	976lm	989lm	972lm	1161lm	1175lm	1155lm	1696lm	1713lm	1684lm	2199lm	2219lm	2181lm
FAS	880lm	880lm	837lm	1047lm	1046lm	995lm	1531lm	1523lm	1449lm	1988lm	1969lm	1873lm
BAC	604lm	598lm	569lm	716lm	710lm	675lm	1038lm	1034lm	984lm	1333lm	1336lm	1271lm
FLE	604lm	598lm	569lm	717lm	710lm	675lm	1039lm	1031lm	981lm	1334lm	1328lm	1263lm
WUR	570lm	568lm	540lm	679lm	676lm	643lm	994lm	990lm	942lm	1293lm	1287lm	1224lm
FIS	924lm	924lm	879lm	1100lm	1098lm	1044lm	1608lm	1599lm	1521lm	2088lm	2067lm	1966lm
FRU	774lm	769lm	731lm	930lm	924lm	879lm	1403lm	1396lm	1328lm	1879lm	1875lm	1783lm

1 TUBE COLOUR

- black matte (RAL 9005)
- high-gloss silver
- silver matte
- high-gloss black chrome
- high-gloss copper
- capital copper
- high-gloss gold
- glaring gold
- gunnery grey

2 HOUSING COLOUR

- SW ■ white
- BB ■ black
- PP ■ RAL of your choice
- ZZ
- KK
- RR
- GG
- DD
- YY

3 LED

- WS ■ 3000 K, CRI > 80 **830**
- SW ■ 4000 K, CRI > 80 **840**
- 2700 K, CRI > 90 **927**
- 3000 K, CRI > 90 **930**
- 3500 K, CRI > 90 **935**
- 4000 K, CRI > 90 **940**
- Fashion (3250 K) **FAS**
- Bakery goods **BAC**
- Meat **FLE**
- Sausage products **WUR**
- Fish **FIS**
- Fruits & vegetables **FRU**

4 OUTPUT

- ⊕ low output
- ⊖ medium output
- ⊙ high output
- ⊛ very high output

5 CONTROL

- L ■ non-dim
- M ■ DALI
- H
- V

6 BEAM

- 23° **2**
- 40° **4**
- 60° **6**

OPTIONAL ACCESSORY

Blendschutz-Wabenraster Honeycomb glare protection Filtre anti-éblouissement nid d'abeilles	S10-BLE-80
Ovalzeichnerlinse Refractor for elliptical distribution Lentille ovalisante	S10-OZL-80
Klares Schutzglas Clear protective glass Verre de protection transparent	S10-SGL-80
Weichzeichnerglas Diffuser protection glass Weichzeichnerglas Verre effet flou	S10-WGL-80

Reflektortausch werkzeuglos möglich. Passive Kühlung.
Replacement of the reflector without the use of any tools. Passive cooling.
Remplacement du réflecteur sans outil. Refroidissement passif.

S10E115-1 2 C1 3 4 5 6

S10E115-RRWSC1830L14 ø 115 mm (fixed), tube capital copper, housing white, IP 20, direct, 3000 K, CRI > 80, low output, non-dim, 40° (order sample)

► Configure online on KATALOG.PLANLICHT.COM



Down to UGR ≤ 16 | up to 118 lm/W | IEC 62471: Blue light hazard: RG ≤ 1 | DALI switchDIM

NEW zenit M swivelling

Einbauleuchte
Recessed luminaire
Luminaire encastré

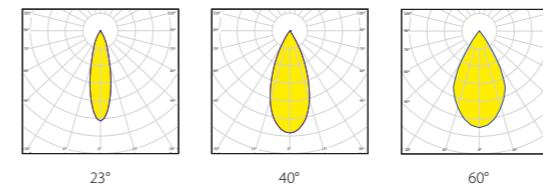

Weight (kg)
0,7 kg

CUT OUT
ø DIAMETER | ↑ DEPTH
ø 110 mm | 131 mm

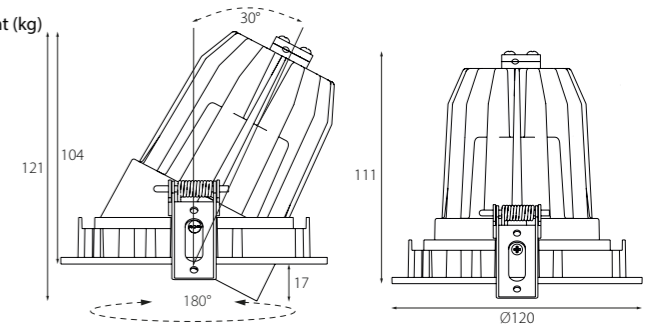

LUMINOUS FLUX (LM) / SYSTEM POWER (W) / BASED ON TUBE COLOUR BLACK MATTE (NN)

	low output (9,3 - 10W)			medium output (11 - 12W)			high output (17 - 18,5W)			very high output (22 - 24W)		
	23°	40°	60°	23°	40°	60°	23°	40°	60°	23°	40°	60°
LF830 3000 K	1112lm	1107lm	1088lm	1322lm	1316lm	1293lm	1931lm	1917lm	1884lm	2505lm	2482lm	2440lm
LF840 4000 K	1180lm	1164lm	1144lm	1404lm	1384lm	1360lm	2050lm	2023lm	1988lm	2658lm	2624lm	2579lm
LF927 2700 K	901lm	899lm	884lm	1072lm	1069lm	1051lm	1565lm	1565lm	1538lm	2029lm	2018lm	1983lm
LF930 3000 K	944lm	952lm	936lm	1122lm	1130lm	1111lm	1629lm	1643lm	1615lm	2102lm	2120lm	2084lm
LF935 3500 K	967lm	974lm	957lm	1151lm	1159lm	1139lm	1687lm	1696lm	1667lm	2196lm	2203lm	2165lm
LF940 4000 K	976lm	989lm	972lm	1161lm	1175lm	1155lm	1696lm	1713lm	1684lm	2199lm	2219lm	2181lm
FAS	880lm	880lm	837lm	1047lm	1046lm	995lm	1531lm	1523lm	1449lm	1988lm	1969lm	1873lm
BAC	604lm	598lm	569lm	716lm	710lm	675lm	1038lm	1034lm	984lm	1333lm	1336lm	1271lm
FLE	604lm	598lm	569lm	717lm	710lm	675lm	1039lm	1031lm	981lm	1334lm	1328lm	1263lm
WUR	570lm	568lm	540lm	679lm	676lm	643lm	994lm	990lm	942lm	1293lm	1287lm	1224lm
FIS	924lm	924lm	879lm	1100lm	1098lm	1044lm	1608lm	1599lm	1521lm	2088lm	2067lm	1966lm
FRU	774lm	769lm	731lm	930lm	924lm	879lm	1403lm	1396lm	1328lm	1879lm	1875lm	1783lm

1 TUBE COLOUR

- black matte (RAL 9005)
- high-gloss silver
- silver matte
- high gloss black chrome
- high-gloss copper
- capital copper
- high-gloss gold
- glaring gold
- gunnery grey

2 HOUSING COLOUR

- SW white
- BB black
- PP RAL of your choice
- ZZ
- KK
- RR
- GG
- DD
- YY

3 LED

- WS 3000 K, CRI > 80 **830**
- SW 4000 K, CRI > 80 **840**
- 3000 K, CRI > 90 **927**
- 3000 K, CRI > 90 **930**
- 3500 K, CRI > 90 **935**
- 4000 K, CRI > 90 **940**
- Fashion (3250 K) **FAS**
- Bakery goods **BAC**
- Meat **FLE**
- Sausage products **WUR**
- Fish **FIS**
- Fruits & vegetables **FRU**

4 OUTPUT

- low output
- medium output
- high output
- very high output

5 CONTROL

- L non-dim
- M DALI
- H
- V

6 BEAM

- 23° **2**
- 40° **4**
- 60° **6**

OPTIONAL ACCESSORY

Blendschutz-Wabenraster Honeycomb glare protection Filtre anti-éblouissement nid d'abeilles	S10-BLE-80
Ovalzeichnerlinse Refractor for elliptical distribution Lentille ovalisante	S10-OZL-80
Klares Schutzglas Clear protective glass Verre de protection transparent	S10-SGL-80
Weichzeichnerglas Diffuser protection glass Weichzeichnerglas Verre effet flou	S10-WGL-80

Reflektortausch werkzeuglos möglich. Passive Kühlung.
Replacement of the reflector without the use of any tools. Passive cooling.
Remplacement du réflecteur sans outil. Refroidissement passif.

S10E120-1 2 C1 3 4 5 6

S10E120-RRWSC1830L14 ø 120 mm (swivelling), tube capital copper, housing white, IP 20, direct, 3000 K, CRI > 80, low output, non-dim, 40° (order sample)

► Configure online on KATALOG.PLANLICHT.COM



Down to UGR ≤ 16 | up to 118 lm/W | IEC 62471: Blue light hazard: RG ≤ 1 | DALI switchDIM

NEW zenit M flip

Einbauleuchte
Recessed luminaire
Luminaire encastré

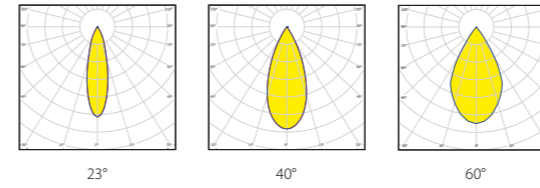
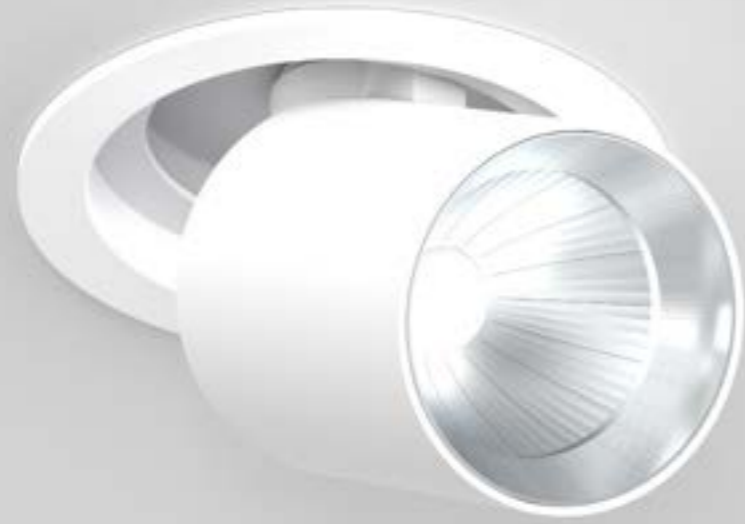

Weight (kg)
1,1 kg

CUT OUT
ø DIAMETER | ↑ DEPTH
ø 130 mm | 181 mm

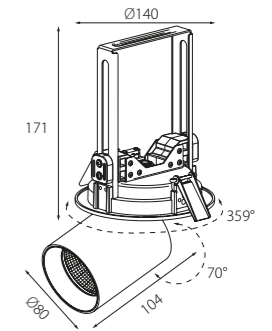

LUMINOUS FLUX (LM) / SYSTEM POWER (W) / BASED ON TUBE COLOUR BLACK MATTE (NN)

	low output (9,3 - 10W)			medium output (11 - 12W)			high output (17 - 18,5W)			very high output (22 - 24W)		
	23°	40°	60°	23°	40°	60°	23°	40°	60°	23°	40°	60°
LF830 3000 K	1112lm	1107lm	1088lm	1322lm	1316lm	1293lm	1931lm	1917lm	1884lm	2505lm	2482lm	2440lm
LF840 4000 K	1180lm	1164lm	1144lm	1404lm	1384lm	1360lm	2050lm	2023lm	1988lm	2658lm	2624lm	2579lm
LF927 2700 K	901lm	899lm	884lm	1072lm	1069lm	1051lm	1565lm	1565lm	1538lm	2029lm	2018lm	1983lm
LF930 3000 K	944lm	952lm	936lm	1122lm	1130lm	1111lm	1629lm	1643lm	1615lm	2102lm	2120lm	2084lm
LF935 3500 K	967lm	974lm	957lm	1151lm	1159lm	1139lm	1687lm	1696lm	1667lm	2196lm	2203lm	2165lm
LF940 4000 K	976lm	989lm	972lm	1161lm	1175lm	1155lm	1696lm	1713lm	1684lm	2199lm	2219lm	2181lm
FAS	880lm	880lm	837lm	1047lm	1046lm	995lm	1531lm	1523lm	1449lm	1988lm	1969lm	1873lm
BAC	604lm	598lm	569lm	716lm	710lm	675lm	1038lm	1034lm	984lm	1333lm	1336lm	1271lm
FLE	604lm	598lm	569lm	717lm	710lm	675lm	1039lm	1031lm	981lm	1334lm	1328lm	1263lm
WUR	570lm	568lm	540lm	679lm	676lm	643lm	994lm	990lm	942lm	1293lm	1287lm	1224lm
FIS	924lm	924lm	879lm	1100lm	1098lm	1044lm	1608lm	1599lm	1521lm	2088lm	2067lm	1966lm
FRU	774lm	769lm	731lm	930lm	924lm	879lm	1403lm	1396lm	1328lm	1879lm	1875lm	1783lm

1 TUBE COLOUR

- black matte (RAL 9005)
- high-gloss silver
- silver matte
- high gloss black chrome
- high-gloss copper
- capital copper
- high-gloss gold
- glaring gold
- gunnery grey

2 HOUSING COLOUR

- SW** white
- BB** black
- PP** RAL of your choice
- ZZ**
- KK**
- RR**
- GG**
- DD**
- YY**

3 LED

- WS** 3000 K, CRI > 80 **830**
- SW** 4000 K, CRI > 80 **840**
- 2700 K, CRI > 90 **927**
- 3000 K, CRI > 90 **930**
- 3500 K, CRI > 90 **935**
- 4000 K, CRI > 90 **940**
- Fashion (3250 K) **FAS**
- Bakery goods **BAC**
- Meat **FLE**
- Sausage products **WUR**
- Fish **FIS**
- Fruits & vegetables **FRU**

4 OUTPUT

- low output
- medium output
- high output
- very high output

5 CONTROL

- L** non-dim
- M** DALI
- H**
- V**

6 BEAM

- 23° **2**
- 40° **4**
- 60° **6**

S10E140-12C13456

S10E140-RRWSC1830L14 ø 140 mm (flip), tube capital copper, housing, white, IP20, direct, 3000 K, CRI > 80, low output, non-dim, 40° (order sample)

► [Configure online on KATALOG.PLANLICHT.COM](https://www.planlicht.com)



Down to UGR ≤ 16 | up to 118 lm/W | IEC 62471: Blue light hazard: RG ≤ 1 | DALI switchDIM

meteor swivelling

Einbaustrahler
Recessed spotlight
Projecteur encastré



1 COLOUR

- white
- black

WSWS
SWSW

2 LED

- 3000 K, CRI > 80
- 4000 K, CRI > 80
- 2700 K, CRI > 90
- 3000 K, CRI > 90
- 3500 K, CRI > 90
- 4000 K, CRI > 90
- Fashion (3250 K)
- Bakery goods
- Meat
- Sausage products
- Fish
- Fruit & vegetables
- dynamic white, Ra > 90

3 OUTPUT

- low output
- medium output
- high output
- very high output
- dynamic white

L
M
H
V
X

4 CONTROL

- non-dim
- DALI, dynamic white

1
3

5 BEAM

- 15°
- 26°
- 38°
- 60°

1
2
3
6 **NEW**

S32E157-1 C1 2 3 4 5

S32E157-SWSWC1935V33 black, IP20, direct, 3500 K, CRI > 90, very high output, DALI, 38° (order sample)

► [Configure online on KATALOG.PLANLICHT.COM](#)

METEOR | RECESSED

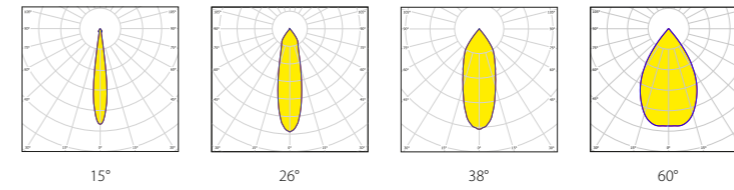

CUT OUT
ø 150 mm, ↑ 131 mm

Weight (kg)
0,8 kg

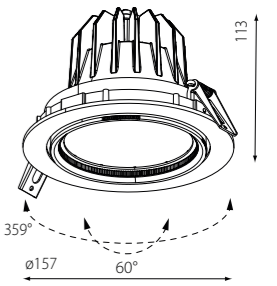

Reflektortausch werkzeuglos möglich.
Passive Kühlung. Komplettstrahler inklusive Reflektor und Konverter.
Replacement of the reflector without any tools.
Passive cooling. Complete spotlight including reflector and converter.
Remplacement du réflecteur sans outil.
Refroidissement passif. Projecteur complet incluant réflecteur et convertisseur.

LUMINOUS FLUX (LM) / SYSTEM POWER (W)

	low output (19,5 - 20 W)				medium output (25 - 26 W)				high output (31 - 32 W)				very high output (41 - 41 W)			
	15°	26°	38°	60°	15°	26°	38°	60°	15°	26°	38°	60°	15°	26°	38°	60°
LF830 3000 K	2587 lm	2729 lm	2727 lm	2813 lm	3246 lm	3429 lm	3428 lm	3657 lm	3850 lm	4072 lm	4073 lm	4500 lm	4734 lm	5021 lm	5028 lm	5907 lm
LF840 4000 K	2726 lm	2880 lm	2874 lm	2841 lm	3426 lm	3626 lm	3618 lm	3693 lm	4072 lm	4318 lm	4305 lm	4546 lm	5028 lm	5349 lm	5330 lm	5966 lm
LF927 2700 K	2104 lm	2230 lm	2222 lm	2255 lm	2646 lm	2802 lm	2794 lm	2932 lm	3145 lm	3330 lm	3322 lm	3608 lm	3884 lm	4111 lm	4104 lm	4736 lm
LF930 3000 K	2220 lm	2392 lm	2387 lm	2762 lm	2799 lm	3008 lm	3003 lm	3590 lm	3335 lm	3577 lm	3572 lm	4419 lm	4140 lm	4421 lm	4416 lm	5800 lm
LF935 3500 K	2288 lm	2461 lm	2452 lm	2879 lm	2890 lm	3107 lm	3094 lm	3743 lm	3454 lm	3712 lm	3693 lm	4607 lm	4306 lm	4623 lm	4594 lm	6046 lm
LF940 4000 K	2311 lm	2487 lm	2482 lm	2958 lm	2908 lm	3125 lm	3122 lm	3846 lm	3459 lm	3712 lm	3711 lm	4733 lm	4277 lm	4580 lm	4588 lm	6213 lm
FAS	1932 lm	2031 lm	2027 lm	2094 lm	2473 lm	2596 lm	2593 lm	2722 lm	2996 lm	3140 lm	3138 lm	3350 lm	3828 lm	4001 lm	4003 lm	4397 lm
BAC	1306 lm	1377 lm	1376 lm	1385 lm	1664 lm	1748 lm	1748 lm	1800 lm	2008 lm	2100 lm	2102 lm	2216 lm	2545 lm	2642 lm	2648 lm	2908 lm
FLE	1310 lm	1379 lm	1378 lm	1392 lm	1671 lm	1754 lm	1753 lm	1810 lm	2017 lm	2110 lm	2108 lm	2227 lm	2561 lm	2663 lm	2661 lm	2923 lm
WUR	1263 lm	1327 lm	1323 lm	1349 lm	1614 lm	1691 lm	1687 lm	1754 lm	1953 lm	2037 lm	2034 lm	2159 lm	2486 lm	2579 lm	2579 lm	2833 lm
FIS	2048 lm	2153 lm	2149 lm	2219 lm	2621 lm	2753 lm	2748 lm	2885 lm	3176 lm	3328 lm	3326 lm	3551 lm	4058 lm	4241 lm	4243 lm	4661 lm
FRU	1935 lm	2031 lm	2019 lm	1934 lm	2439 lm	2548 lm	2534 lm	2515 lm	2908 lm	3023 lm	3006 lm	3095 lm	3610 lm	3720 lm	3698 lm	4062 lm

LUMINOUS FLUX (LM) / SYSTEM POWER (W)

	dynamic white (43 W)			
	15°	26°	38°	60°
dynamic white	2431 lm	2600 lm	2576 lm	2487 lm

OPTIONAL ACCESSORY

Blendschutz-Wabenraster Honeycomb glare protection Filtre anti-éblouissement nid d'abeilles	S10-BLE-99
Ovalzeichnerlinse Refractor for elliptical distribution Lentille ovalisante	S10-OZL-99
Klares Schutzglas Clear protective glass Verre de protection transparent	S10-SGL-99
Weichzeichnerglas Diffuser protection glass Weichzeichnerglas Verre effet flou	S10-WGL-99



Down to UGR ≤ 19 | up to 138 lm/W | IEC 62471: Blue light hazard: RG ≤ 1 | DALI switchDIM

meteor flip

Einbaustrahler
Recessed spotlight
Projecteur encastré



1 COLOUR

- white
- black

WSWS
SWSW

2 LED

- 3000 K, CRI > 80
- 4000 K, CRI > 80
- 2700 K, CRI > 90
- 3000 K, CRI > 90
- 3500 K, CRI > 90
- 4000 K, CRI > 90
- Fashion (3250 K)
- Bakery goods
- Meat
- Sausage products
- Fish
- Fruits & vegetables
- dynamic white, CRI > 90

3 OUTPUT/CONTROL

- low output
- medium output
- high output
- dynamic white, CRI > 90

L
M
H
X

4 CONTROL

- non-dim
- DALI, dynamic white

1
3

5 BEAM

- 15°
- 26°
- 48°
- 60°

1
2
4 **NEW**
6 **NEW**

S03E180-1 C1 2 3 4 5

S03E180-WSWSC1930H31 white, IP 20, direct, 3000 K, CRI > 90, high output, DALI, 15° (order sample)

► Configure online on [KATALOG.PLANLICHT.COM](https://www.planlicht.com)

METEOR FLIP

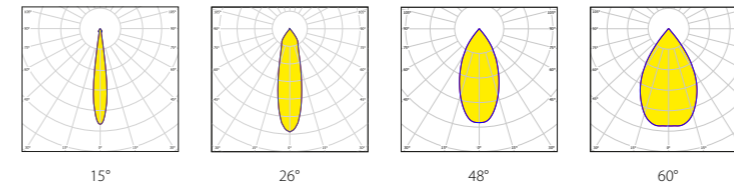

CUT OUT
ø 170 mm, ↑ 180 mm

Weight (kg)
1,3 kg

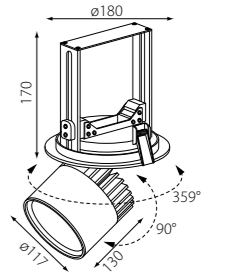

Reflektortausch werkzeuglos möglich.
Passive Kühlung. Komplettstrahler inklusive Reflektor und Konverter.
Replacement of the reflector without any tools.
Passive cooling. Complete spotlight including reflector and converter.
Remplacement du réflecteur sans outil.
Refroidissement passif. Projecteur complet incluant réflecteur et convertisseur.

LUMINOUS FLUX (LM) / SYSTEM POWER (W)

	low output (19,5 - 20 W)				medium output (23 - 24 W)				high output (31 - 32 W)			
	15°	26°	48°	60°	15°	26°	48°	60°	15°	26°	48°	60°
LF830 3000 K	2687 lm	2633 lm	2543 lm	2650 lm	3184 lm	3121 lm	3014 lm	3142 lm	4141 lm	4059 lm	3919 lm	4085 lm
LF840 4000 K	2714 lm	2660 lm	2568 lm	2677 lm	3216 lm	3153 lm	3044 lm	3173 lm	4182 lm	4099 lm	3958 lm	4126 lm
LF927 2700 K	2154 lm	2111 lm	2039 lm	2125 lm	2553 lm	2503 lm	2417 lm	2519 lm	3320 lm	3254 lm	3142 lm	3275 lm
LF930 3000 K	2598 lm	2547 lm	2460 lm	2563 lm	3070 lm	3009 lm	2906 lm	3029 lm	3965 lm	3886 lm	3753 lm	3911 lm
LF935 3500 K	2709 lm	2655 lm	2564 lm	2673 lm	3201 lm	3137 lm	3029 lm	3157 lm	4133 lm	4051 lm	3912 lm	4078 lm
LF940 4000 K	2783 lm	2728 lm	2635 lm	2746 lm	3288 lm	3223 lm	3113 lm	3244 lm	4247 lm	4163 lm	4020 lm	4190 lm
FAS	2000 lm	1960 lm	1893 lm	1973 lm	2370 lm	2323 lm	2244 lm	2338 lm	3082 lm	3021 lm	2917 lm	3041 lm
BAC	1323 lm	1297 lm	1252 lm	1305 lm	1568 lm	1537 lm	1484 lm	1547 lm	2039 lm	1998 lm	1930 lm	2011 lm
FLE	1330 lm	1303 lm	1258 lm	1312 lm	1576 lm	1545 lm	1492 lm	1555 lm	2049 lm	2009 lm	1940 lm	2022 lm
WUR	1289 lm	1263 lm	1220 lm	1271 lm	1527 lm	1497 lm	1446 lm	1507 lm	1986 lm	1947 lm	1880 lm	1959 lm
FIS	2120 lm	2078 lm	2007 lm	2091 lm	2513 lm	2463 lm	2378 lm	2479 lm	3267 lm	3202 lm	3092 lm	3223 lm
FRU	1848 lm	1811 lm	1749 lm	1823 lm	2190 lm	2147 lm	2073 lm	2161 lm	2848 lm	2791 lm	2695 lm	2809 lm

LUMINOUS FLUX (LM) / SYSTEM POWER (W)

	dynamic white (43 W)			
	15°	26°	48°	60°
dynamic white	2420 lm	2348 lm	2410 lm	2487 lm

OPTIONAL ACCESSORY

Blendschutz-Wabenraster Honeycomb glare protection Filtre anti-éblouissement nid d'abeilles	S10-BLE-99
Ovalzeichnerlinse Refractor for elliptical distribution Lentille ovalisante	S10-OZL-99
Klares Schutzglas Clear protective glass Verre de protection transparent	S10-SGL-99
Weichzeichnerglas Diffuser protection glass Weichzeichnerglas Verre effet flou	S10-WGL-99



Down to UGR ≤ 16 | up to 139 lm/W | IEC 62471: Blue light hazard: RG ≤ 1 | DALI switchDIM

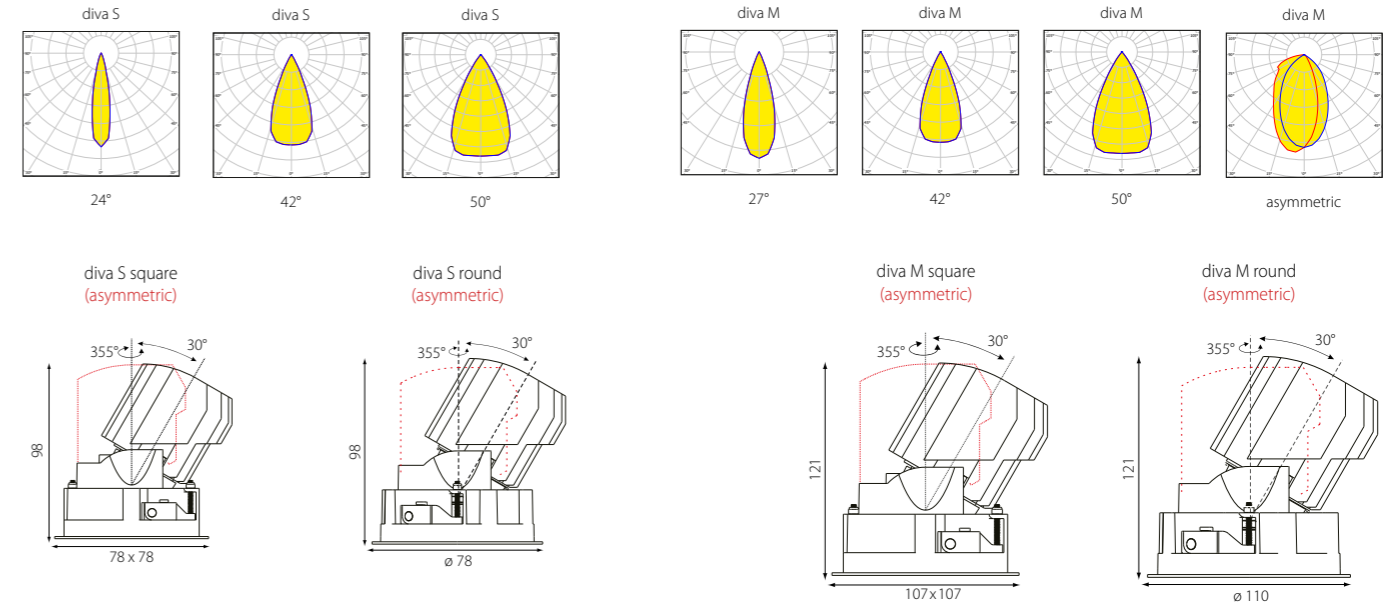

CUT OUT

diva S	ø 68 mm, ↑ 148 mm
diva S square	□ 68 x 68 mm, ↑ 148 mm

CUT OUT

diva M	ø 100 mm, ↑ 180 mm
diva M square	□ 96 x 96 mm, ↑ 180 mm

LUMINOUS FLUX (LM) / SYSTEM POWER (W)

diva S	low output (9,8W)			high output (13,5W)				kg
	24°	42°	50°	24°	42°	50°		
Reflector high-gloss silver								
3000 K, CRI > 90	600 lm	664 lm	632 lm	824 lm	911 lm	867 lm		0,3 kg
4000 K, CRI > 90	653 lm	722 lm	687 lm	896 lm	991 lm	943 lm		0,3 kg

diva M	low output (15W)				high output (21W)				kg
	27°	42°	50°	asym.	27°	42°	50°	asym.	
Reflector high-gloss silver									
3000 K, CRI > 90	1399 lm	1416 lm	1347 lm	971 lm	1959 lm	1982 lm	1886 lm	1359 lm	0,5 kg
4000 K, CRI > 90	1506 lm	1523 lm	1450 lm	971 lm	2108 lm	2133 lm	2029 lm	1359 lm	0,5 kg

1 SIZE / SHAPE	2 REFLECTOR COLOUR	3 HOUSING COLOUR
diva M (round) 110	white matte	white WS
diva M square 10Q	black matte	black SW
diva S (round) 078	silver matte	
diva S square 07Q	high-gloss silver	
	high-gloss gold	

4 LED	5 OUTPUT / CONTROL	6 BEAM
3000 K, CRI > 90 930	low output non-dim L1	24° (diva S) 2
4000 K, CRI > 90 940	high output non-dim H1	27° (diva M) 2
	high output DALI H3	42° 4
		50° 5
		asymmetric wallwasher (only diva M, silver matte) A

S42E1-N23C1456

S42E110-NGWSC1940H34 diva M, round, reflector gold, housing white, IP 20, 4000 K, CRI > 90, high output DALI, 42° (order sample)

► Configure online on KATALOG.PLANLICHT.COM

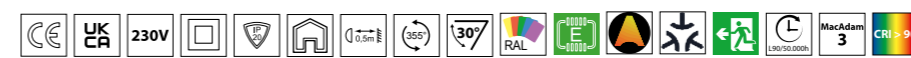

Down to UGR ≤ 16 | up to 102 lm/W | IEC 62471: Blue light hazard: RG ≤ 1 | DALI switchDIM

NEW diva S square multiple

Einbaustrahler
Recessed spotlight
Projecteur encastré



1 SIZE / SHAPE

- 2** 134 x 68 mm
- 3** 198 x 68 mm
- 4** 134 x 134 mm

2 SECONDARY REFLECTOR COLOUR

- 014** white matte
- 020** black matte
- 14Q** silver matte
- high-gloss silver
- high-gloss gold

3 HOUSING COLOUR

- W** white
- N** black
- P**
- B**
- G**
- WS**
- SW**

4 SPOTLIGHTS

- 2** 2 spots (014 only)
- 3** 3 spots (020 only)
- 4** 4 spots (14Q only)

5 LED

- 2** 3000 K, CRI > 90
- 3** 4000 K, CRI > 90
- 4**

6 OUTPUT / CONTROL

- 930** low output non-dim
- H1** high output non-dim
- H3** high output DALI

7 BEAM

- 2** 24°
- 4** 42°
- 5** 50°

S42E 1-N 2 3 C 4 5 6 7

S42E020-NPWSC3940H34 diva S square, recessed, secondary reflector silver matte, housing white, IP 20, 1 x 3 linear, 4000 K, CRI > 90, high output DALI, 42° (order sample)

➤ [Configure online on KATALOG.PLANLICHT.COM](#)

DIVA S SQUARE MULTIPLE | RECESSED

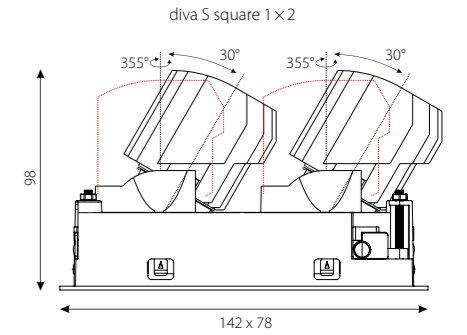
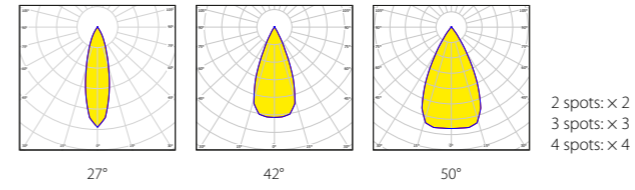

CUT OUT 0,9 kg
diva S square (2 spots) □ 134 x 68 mm, ↑ 148 mm

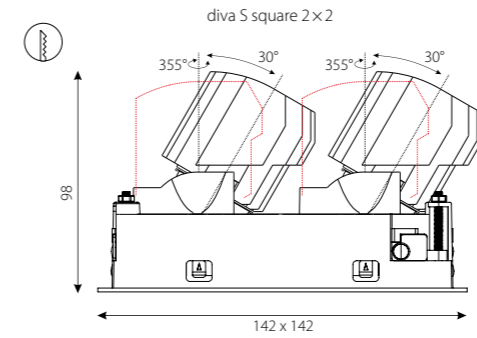

CUT OUT 1,7 kg
diva S square (4 spots) □ 134 x 134 mm, ↑ 148 mm

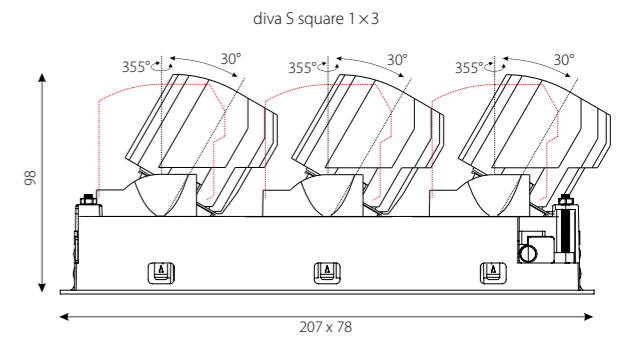

CUT OUT 1,3 kg
diva S square (3 spots) □ 198 x 68 mm, ↑ 148 mm

LUMINOUS FLUX (LM) / SYSTEM POWER (W)

diva S (per spot)	low output (9,8W)			high output (13,5W)		
	24°	42°	50°	24°	42°	50°
Reflector high-gloss silver	600 lm	664 lm	632 lm	824 lm	911 lm	867 lm
3000 K, CRI > 90						
4000 K, CRI > 90	653 lm	722 lm	687 lm	896 lm	991 lm	943 lm

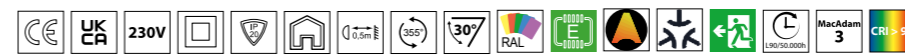

Down to UGR ≤ 16 | up to 74 lm/W | IEC 62471: Blue light hazard: RG ≤ 1 | DALI switchDIM

cosmo

Einbaustrahler
Recessed spotlight
Projecteur encastré



COSMO | RECESSED

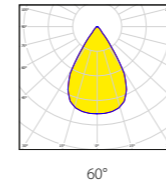

60°

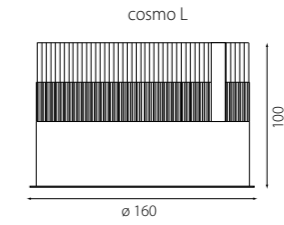

cosmo L

100

160



CUT OUT
ø 150 mm, ↑ 150 mm

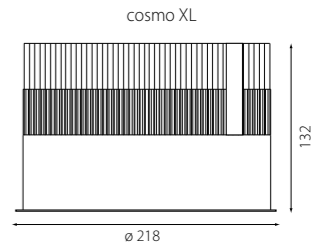

cosmo XL

132

218



CUT OUT
ø 205 mm, ↑ 176 mm

LUMINOUS FLUX (LM) / SYSTEM POWER (W)

cosmo XL	low output (27W)	high output (41W)	very high output (54W)	
Reflector silver matte	60°	60°	60°	
3000 K, CRI > 90	2713 lm	4069 lm	5426 lm	1,7 kg
4000 K, CRI > 90	2893 lm	4340 lm	5789 lm	1,7 kg

cosmo L	low output (20W)	high output (28W)	
Reflector silver matte	60°	60°	
3000 K, CRI > 90	2051 lm	2871 lm	0,9 kg
4000 K, CRI > 90	2270 lm	3179 lm	0,9 kg

1 SIZE

cosmo XL	218
cosmo L	160

2 REFLECTOR COLOUR

black matte	N
silver matte	P

3 HOUSING COLOUR

white	WS
black	SW

4 LED

3000 K, CRI > 90	930
4000 K, CRI > 90	940

5 OUTPUT/CONTROL

low output non-dim	L1
high output non-dim	H1
high output DALI	H3
very high output DALI	V3

S38E 1-L 2 3 Q1 4 5 6

S38E218-LNWSQ1930V36 cosmo XL, reflector white, housing black, IP 54, direct, CRI > 90, 3000K, very high output DALI, 60° (order sample)

► [Configure online on KATALOG.PLANLICHT.COM](#)



Down to UGR ≤ 16 | up to 114 lm/W | IEC 62471: Blue light hazard: RG ≤ 1 | DALI switchDIM

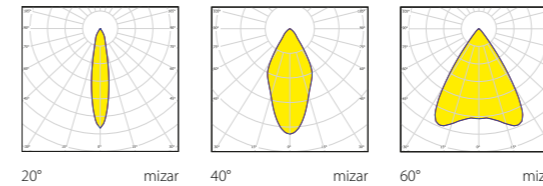

CUT OUT
ø 125 mm, ↑ 120 mm

Weight (kg)
0,8 kg

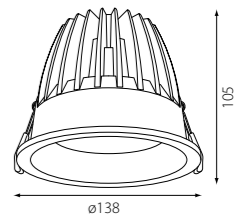

LUMINOUS FLUX (LM) / SYSTEM POWER (W)

mizar	low output (15 W)			medium output (18,5 - 19 W)			high output (23 W)			very high output (34 W)			dynamic white (38 W)		
	20°	40°	60°	20°	40°	60°	20°	40°	60°	20°	40°	60°	20°	40°	60°
LF830 3000 K	1826 lm	1707 lm	1816 lm	2244 lm	2096 lm	2232 lm	2647 lm	2470 lm	2631 lm	3760 lm	3505 lm	3739 lm			
LF840 4000 K	1965 lm	1833 lm	1959 lm	2417 lm	2254 lm	2410 lm	2855 lm	2661 lm	2845 lm	4074 lm	3791 lm	4058 lm			
LF927 2700 K	1472 lm	1431 lm	1473 lm	1815 lm	1749 lm	1813 lm	2148 lm	2051 lm	2142 lm	3089 lm	2863 lm	3062 lm			
LF930 3000 K	1569 lm	1486 lm	1587 lm	1933 lm	1831 lm	1955 lm	2285 lm	2165 lm	2310 lm	3270 lm	3102 lm	3309 lm			
LF935 3500 K	1639 lm	1544 lm	1643 lm	2016 lm	1901 lm	2023 lm	2378 lm	2246 lm	2388 lm	3388 lm	3216 lm	3412 lm			
LF940 4000 K	1649 lm	1550 lm	1656 lm	2030 lm	1908 lm	2037 lm	2397 lm	2255 lm	2405 lm	3426 lm	3223 lm	3432 lm			
dynamic white													2040 lm	1904 lm	2031 lm

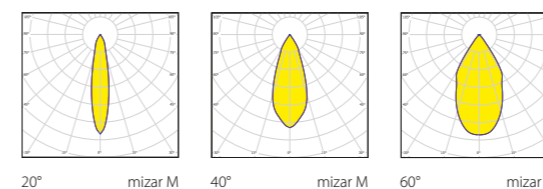

CUT OUT
ø 150 mm, ↑ 150 mm

Weight (kg)
1,1 kg

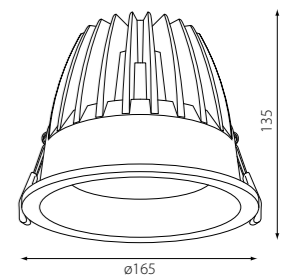

LUMINOUS FLUX (LM) / SYSTEM POWER (W)

mizar M	low output (15 - 15,5 W)			medium output (23 W)			high output (30 W)			very high output (38 W)			dynamic white (43 W)		
	20°	40°	60°	20°	40°	60°	20°	40°	60°	20°	40°	60°	20°	40°	60°
LF830 3000 K	1897 lm	1880 lm	1962 lm	2777 lm	2745 lm	2862 lm	3612 lm	3562 lm	3707 lm	4400 lm	4329 lm	4499 lm			
LF840 4000 K	2046 lm	2024 lm	2124 lm	2991 lm	2952 lm	3090 lm	3884 lm	3824 lm	3992 lm	4725 lm	4641 lm	4831 lm			
LF927 2700 K	1539 lm	1517 lm	1537 lm	2246 lm	2211 lm	2244 lm	2913 lm	2862 lm	2911 lm	3537 lm	3470 lm	3535 lm			
LF930 3000 K	1662 lm	1643 lm	1722 lm	2433 lm	2399 lm	2515 lm	3164 lm	3111 lm	3264 lm	3854 lm	3780 lm	3968 lm			
LF935 3500 K	1707 lm	1693 lm	1772 lm	2500 lm	2475 lm	2593 lm	3253 lm	3216 lm	3372 lm	3965 lm	3914 lm	4109 lm			
LF940 4000 K	1721 lm	1705 lm	1762 lm	2519 lm	2490 lm	2590 lm	3276 lm	3230 lm	3385 lm	3990 lm	3927 lm	4143 lm			
dynamic white													2323 lm	2301 lm	2352 lm

Komplettstrahler inklusive Reflektor und Konverter.
Complete spotlight including reflector and converter.
Projecteur complet incluant réflecteur et convertisseur.

1 SIZE

mizar	138
mizar M	165

2 COLOUR

	white
	black
	silver

WSWS

3 LED

	3000 K, CRI > 80	830
	4000 K, CRI > 80	840
	2700 K, CRI > 90	927
	3000 K, CRI > 90	930
	3500 K, CRI > 90	935
	4000 K, CRI > 90	940
	dynamic white, CRI > 90	HCL

4 OUTPUT

	low output
	medium output
	high output
	very high output
	dynamic white

L
M
H
V
X

5 CONTROL

	non-dim
	DALI

1
3

6 BEAM

	20°	2
	40°	4
	60°	6

S34E 1-2 P1 3 4 5 6

S34E138-WSWSP1HCLX34 mizar, white, IP 44, direct, dynamic white, DALI, 40° (order sample)

► Configure online on [KATALOG.PLANLICHT.COM](https://www.katalog.planlicht.com)



Down to UGR ≤ 19 | up to 142 lm/W | IEC 62471: Blue light hazard: RG ≤ 1 | DALI switchDIM

taurus

Einbaustrahler
Recessed spotlight
Projecteur encastré



1 SIZE

taurus	162
taurus M	188

2 COLOUR

	white
	black
	silver

WSWS

SWSW

SISI

3 LED

	3000 K, CRI > 80	830
	4000 K, CRI > 80	840
	2700 K, CRI > 90	927
	3000 K, CRI > 90	930
	3500 K, CRI > 90	935
	4000 K, CRI > 90	940
	dynamic white, CRI > 90	HCL

4 OUTPUT

	low output
	medium output
	high output
	very high output (only taurus M)
	dynamic white

L

M

H

V

X

5 CONTROL

	non-dim	1
	DALI	3

5 BEAM

	20°	2
	40°	4
	60°	6

S35E 1-2 C1 3 4 5 6

S35E162-SWSWC1940H16 taurus, black, IP 20, direct, CRI > 90, 4000 K, high output, non-dim, 60° (order sample)

► [Configure online on KATALOG.PLANLICHT.COM](#)

TAURUS | RECESSED

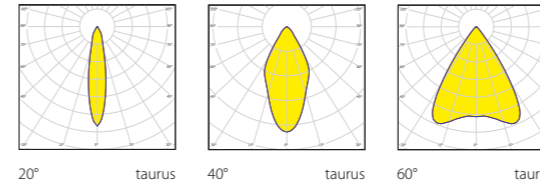

CUT OUT
ø 150 mm, ↑ 150 mm

Weight (kg)
0,9 kg

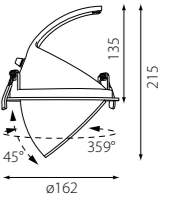

LUMINOUS FLUX (LM) / SYSTEM POWER (W)

taurus	low output (15 W)			medium output (18,5 - 19 W)			high output (23 W)			dynamic white (43 W)		
	20°	40°	60°	20°	40°	60°	20°	40°	60°	20°	40°	60°
LF830 3000 K	1826 lm	1707 lm	1816 lm	2244 lm	2096 lm	2232 lm	2647 lm	2470 lm	2631 lm			
LF840 4000 K	1965 lm	1833 lm	1959 lm	2417 lm	2254 lm	2410 lm	2855 lm	2661 lm	2845 lm			
LF927 2700 K	1472 lm	1431 lm	1473 lm	1815 lm	1749 lm	1813 lm	2148 lm	2051 lm	2142 lm			
LF930 3000 K	1569 lm	1486 lm	1587 lm	1933 lm	1831 lm	1955 lm	2285 lm	2165 lm	2310 lm			
LF935 3500 K	1639 lm	1544 lm	1643 lm	2016 lm	1901 lm	2023 lm	2378 lm	2246 lm	2388 lm			
LF940 4000 K	1649 lm	1550 lm	1656 lm	2030 lm	1908 lm	2037 lm	2397 lm	2255 lm	2405 lm			
dynamic white										2255 lm	2104 lm	2245 lm

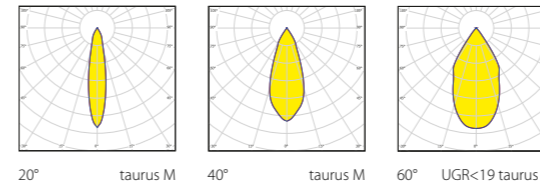

CUT OUT
ø 175 mm, ↑ 180 mm

Weight (kg)
1,2 kg

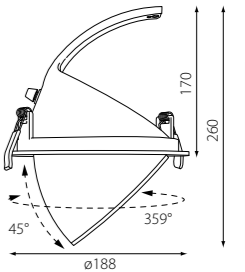

LUMINOUS FLUX (LM) / SYSTEM POWER (W)

taurus M	low output (15 - 15,5 W)			medium output (19 W)			high output (23 W)			very high output (32 W)			dynamic white (43 W)		
	20°	40°	60°	20°	40°	60°	20°	40°	60°	20°	40°	60°	20°	40°	60°
LF830 3000 K	1897 lm	1880 lm	1962 lm	2343 lm	2319 lm	2419 lm	2777 lm	2745 lm	2862 lm	3813 lm	3758 lm	3911 lm			
LF840 4000 K	2046 lm	2024 lm	2124 lm	2525 lm	2494 lm	2615 lm	2991 lm	2952 lm	3090 lm	4099 lm	4034 lm	4208 lm			
LF927 2700 K	1538 lm	1517 lm	1537 lm	1898 lm	1870 lm	1896 lm	2246 lm	2211 lm	2244 lm	3073 lm	3018 lm	3070 lm			
LF930 3000 K	1662 lm	1643 lm	1722 lm	2053 lm	2027 lm	2124 lm	2433 lm	2399 lm	2515 lm	3340 lm	3283 lm	3444 lm			
LF935 3500 K	1707 lm	1693 lm	1772 lm	2108 lm	2089 lm	2188 lm	2500 lm	2475 lm	2593 lm	3434 lm	3394 lm	3561 lm			
LF940 4000 K	1721 lm	1705 lm	1762 lm	2126 lm	2103 lm	2180 lm	2519 lm	2490 lm	2590 lm	3458 lm	3409 lm	3577 lm			
dynamic white													2323 lm	2301 lm	2352 lm

Komplettstrahler inklusive Reflektor und Konverter.
Complete spotlight including reflector and converter.
Projecteur complet incluant réflecteur et convertisseur.



Down to UGR ≤ 19 | up to 142 lm/W | IEC 62471: Blue light hazard: RG ≤ 1 | DALI switchDIM

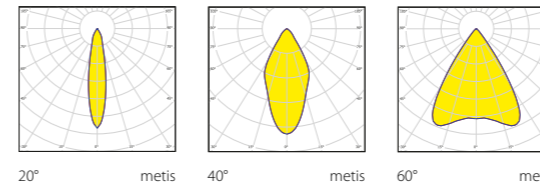

CUT OUT
□ 125x125 mm, ↑ 140 mm

Weight (kg)
0,9 kg

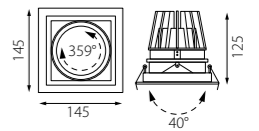

LUMINOUS FLUX (LM) / SYSTEM POWER (W)

metis	low output (15W)			medium output (18,5 - 19W)			high output (23W)			dynamic white (38W)		
	20°	40°	60°	20°	40°	60°	20°	40°	60°	20°	40°	60°
LF830 3000 K	1826 lm	1707 lm	1816 lm	2244 lm	2096 lm	2232 lm	2647 lm	2470 lm	2631 lm			
LF840 4000 K	1965 lm	1833 lm	1959 lm	2417 lm	2254 lm	2410 lm	2855 lm	2661 lm	2845 lm			
LF927 2700 K	1472 lm	1431 lm	1473 lm	1815 lm	1749 lm	1813 lm	2148 lm	2051 lm	2142 lm			
LF930 3000 K	1569 lm	1486 lm	1587 lm	1933 lm	1831 lm	1955 lm	2285 lm	2165 lm	2310 lm			
LF935 3500 K	1639 lm	1544 lm	1643 lm	2016 lm	1901 lm	2023 lm	2378 lm	2246 lm	2388 lm			
LF940 4000 K	1649 lm	1550 lm	1656 lm	2030 lm	1908 lm	2037 lm	2397 lm	2255 lm	2405 lm			
dynamic white										2040 lm	1904 lm	2031 lm

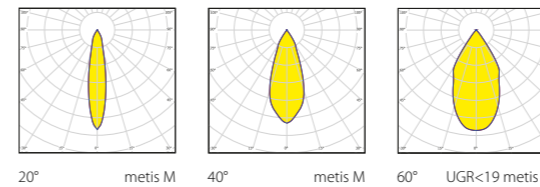

CUT OUT
□ 155x155 mm, ↑ 171 mm

Weight (kg)
1,3 kg

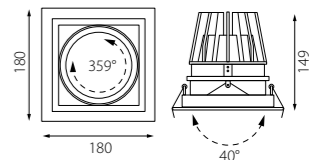

LUMINOUS FLUX (LM) / SYSTEM POWER (W)

metis M	low output (13-13,5W)			medium output (18,5-19W)			high output (23W)			very high output (26-27W)			dynamic white (43W)		
	20°	40°	60°	20°	40°	60°	20°	40°	60°	20°	40°	60°	20°	40°	60°
LF830 3000 K	1670 lm	1655 lm	1729 lm	2343 lm	2319 lm	2419 lm	2777 lm	2746 lm	2861 lm	3200 lm	3160 lm	3291 lm			
LF840 4000 K	1802 lm	1783 lm	1872 lm	2525 lm	2494 lm	2615 lm	2991 lm	2952 lm	3090 lm	3444 lm	3395 lm	3549 lm			
LF927 2700 K	1356 lm	1337 lm	1354 lm	1898 lm	1870 lm	1896 lm	2246 lm	2211 lm	2245 lm	2585 lm	2542 lm	2583 lm			
LF930 3000 K	1463 lm	1448 lm	1516 lm	2053 lm	2027 lm	2124 lm	2433 lm	2399 lm	2515 lm	2803 lm	2761 lm	2895 lm			
LF935 3500 K	1502 lm	1490 lm	1560 lm	2108 lm	2089 lm	2188 lm	2501 lm	2476 lm	2593 lm	2882 lm	2852 lm	2988 lm			
LF940 4000 K	1515 lm	1502 lm	1549 lm	2126 lm	2103 lm	2180 lm	2520 lm	2489 lm	2591 lm	2904 lm	2865 lm	2992 lm			
dynamic white													2323 lm	2301 lm	2352 lm

Komplettstrahler inklusive Reflektor und Konverter.
Complete spotlight including reflector and converter.
Projecteur complet incluant réflecteur et convertisseur.

1 SIZE

metis	145
metis M	180

2 COLOUR



WSWS
SWSW
SISI

3 LED

	3000 K, CRI > 80	830
	4000 K, CRI > 80	840
	2700 K, CRI > 90	927
	3000 K, CRI > 90	930
	3500 K, CRI > 90	935
	4000 K, CRI > 90	940
	dynamic white, CRI > 90	HCL

4 OUTPUT

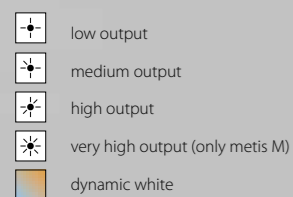

L
M
H
V
X

5 CONTROL



1
3

5 BEAM

	20°	2
	40°	4
	60°	6

S37E 1-2 C1 3 4 5 6

S37E145-SISIC1840M32 metis, silver, IP 20, direct, CRI > 80, 4000 K, medium output, DALI, 20° (order sample)

► Configure online on KATALOG.PLANLICHT.COM



Down to UGR ≤ 16 | up to 131 lm/W | IEC 62471: Blue light hazard: RG ≤ 1 | DALI switchDIM

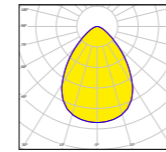

CUT OUT
ø 175-200 mm,
↑ 100 mm

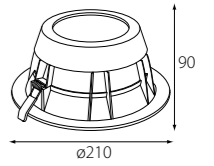

leda		3000 K	4000 K
250 mA/DC	11 W	1542 lm	1585 lm
350 mA/DC	16 W	2274 lm	2337 lm
500 mA/DC	23 W	3249 lm	3339 lm
700 mA/DC	29 W	3902 lm	4010 lm

ELECTRICAL SPECIFICATION

	V_{fmin}	V_{fmax}	
LED power consumption @ 250 mA	8,9 W	33,4 V	38,2 V
LED power consumption @ 350 mA	12,7 W	33,9 V	38,8 V
LED power consumption @ 500 mA	18,6 W	34,7 V	39,7 V
LED power consumption @ 700 mA	26,7 W	35,6 V	40,8 V

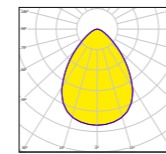

CUT OUT
ø 200-220 mm,
↑ 110 mm

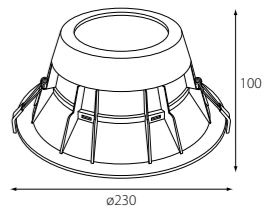

leda M		3000 K	4000 K
250 mA/DC	11 W	1533 lm	1576 lm
350 mA/DC	16 W	2255 lm	2318 lm
500 mA/DC	23 W	3222 lm	3312 lm
700 mA/DC	29 W	3899 lm	4007 lm

ELECTRICAL SPECIFICATION

	V_{fmin}	V_{fmax}	
LED power consumption @ 250 mA	8,9 W	33,4 V	38,2 V
LED power consumption @ 350 mA	12,7 W	33,9 V	38,8 V
LED power consumption @ 500 mA	18,6 W	34,7 V	39,7 V
LED power consumption @ 700 mA	26,7 W	35,6 V	40,8 V

RECOMMENDED DRIVERS

	non-dim	DALI
250 mA/DC	3587500627	3587500921-0250MA
350 mA/DC	3587500627	3587500921-0350MA
500 mA/DC	423-5941005-SR1	3587500922-0500MA
700 mA/DC	3587500605	3587500923-0700MA

1 SIZE 2 COLOUR 3 LED 4 ORDER NUMBER

leda S	<input type="checkbox"/>	white	<input type="checkbox"/>	3000 K, CRI > 90	761-0003-V2
	<input type="checkbox"/>	white	<input type="checkbox"/>	4000 K, CRI > 90	761-0004-V2
leda M	<input type="checkbox"/>	white	<input type="checkbox"/>	3000 K, CRI > 90	761-0005-V2
	<input type="checkbox"/>	white	<input type="checkbox"/>	4000 K, CRI > 90	761-0006-V2

oslo & toulon

Einbastrahler
Recessed spotlight
Projecteur encastré

OSLO & TOULON | RECESSED

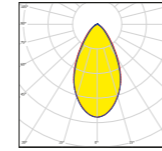

oslo

LUMINOUS FLUX (LM)

2700 K	952 lm	15,5 W
3000 K	981 lm	15,5 W
4000 K	1051 lm	15,5 W

RECOMMENDED DRIVERS

	non-dim	DALI
350 mA/DC	423-5941005-SR1	3587500921-0350MA

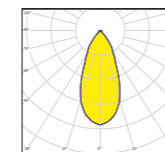

toulon

LUMINOUS FLUX (LM)

	white	silver	black	
2700 K	580 lm	564 lm	552 lm	7,4 W
3000 K	650 lm	631 lm	604 lm	7,4 W
4000 K	705 lm	663 lm	672 lm	7,4 W

RECOMMENDED DRIVERS

	non-dim	DALI
350 mA/DC	3528003348	3587500921-0350MA

ACCESSORIES

Protective glass IP44	761-0002
-----------------------	----------

CUT OUT
ø 75 mm, ↑ 90 mm

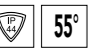
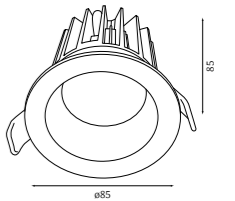

CUT OUT
ø 68 mm, ↑ 45 mm

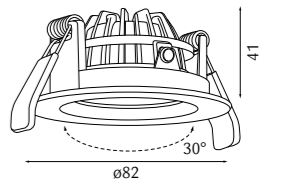

1 TYPE 2 COLOUR 3 LED 4 ORDER NUMBER

Type	Colour	LED	Order Number
oslo	white	2700 K, CRI > 90	740119WS-27K-V1
		3000 K, CRI > 90	740119WS-30K-V1
		4000 K, CRI > 90	740119WS-40K-V1
toulon	white	2700 K, CRI > 90	761-0001WS-27K-V3
		2700 K, CRI > 90	761-0001SW-27K-V3
		2700 K, CRI > 90	761-0001SI-27K-V3
	black	3000 K, CRI > 90	761-0001WS-30K-V3
		3000 K, CRI > 90	761-0001SW-30K-V3
		3000 K, CRI > 90	761-0001SI-30K-V3
	silver	3000 K, CRI > 90	761-0001SI-30K-V3
		4000 K, CRI > 90	761-0001WS-40K-V3
		4000 K, CRI > 90	761-0001SW-40K-V3
silver	4000 K, CRI > 90	761-0001SI-40K-V3	

► Configure online on KATALOG.PLANLICHT.COM

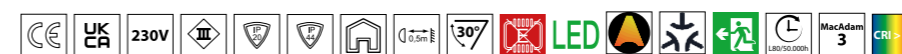

350 mA DC | IEC 62471: Blue light hazard: RG ≤ 1

spot 85 RZ & spot 90 EZ

Einbaustrahler
Recessed spotlight
Projecteur encastré



1 TYPE **2 COLOUR** **3 LED** **4 ORDER NUMBER**

TYPE	COLOUR	LED	ORDER NUMBER	
spot 85 RZ	white	2700 K, CRI > 80	740115WS-27K	
	black	2700 K, CRI > 80	740115SW-27K	
	white	3000 K, CRI > 90	740115WS-930	
	black	3000 K, CRI > 90	740115SW-930	
	white	4000 K, CRI > 90	740115WS-940	
	black	4000 K, CRI > 90	740115SW-940	
	white	2700 K, CRI > 80	740115WS-27K-IP44	
	black	2700 K, CRI > 80	740115SW-27K-IP44	
	white	3000 K, CRI > 90	740115WS-930-IP44	
	black	3000 K, CRI > 90	740115SW-930-IP44	
	white	4000 K, CRI > 90	740115WS-940-IP44	
	black	4000 K, CRI > 90	740115SW-940-IP44	
	spot 90 EZ	white	2700 K, CRI > 80	740114WS-27K
		black	2700 K, CRI > 80	740114SW-27K
		white	3000 K, CRI > 90	740114WS-930
		black	3000 K, CRI > 90	740114SW-930
		white	4000 K, CRI > 90	740114WS-940
		black	4000 K, CRI > 90	740114SW-940
white		2700 K, CRI > 80	740114WS-27K-IP44	
black		2700 K, CRI > 80	740114SW-27K-IP44	
white		3000 K, CRI > 90	740114WS-930-IP44	
black		3000 K, CRI > 90	740114SW-930-IP44	
white		4000 K, CRI > 90	740114WS-940-IP44	
black		4000 K, CRI > 90	740114SW-940-IP44	

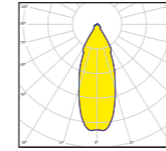

LUMINOUS FLUX (LM)

spot 85 RZ	IP20 / 14,5W	IP44 / 14,5W
2700 K CRI > 80	1350 lm	1090 lm
3000 K CRI > 90	1157 lm	995 lm
4000 K CRI > 90	1128 lm	970 lm

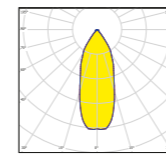

LUMINOUS FLUX (LM)

spot 90 EZ	IP20 / 14,5W	IP44 / 14,5W
2700 K CRI > 80	1372 lm	1180 lm
3000 K CRI > 90	1177 lm	1074 lm
4000 K CRI > 90	1184 lm	1082 lm

RECOMMENDED DRIVERS

	non-dim	DALI
350 mA/DC	423-5941005-SR1	3587500921-0350MA

SPOT 85 RZ & SPOT 90 EZ | RECESSED

CUT OUT
ø80 mm, ↑ 130 mm

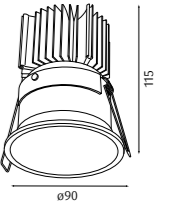

CUT OUT
84x84 mm,
↑ 130 mm

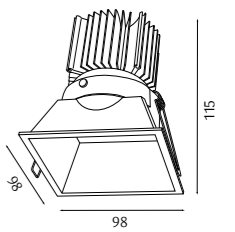

350 mA DC | IEC 62471: Blue light hazard: RG ≤ 1

► Configure online on KATALOG.PLANLICHT.COM

spot 82

Einbastrahler
Recessed spotlight
Projecteur encastré



SPOT 82 E / SPOT 82 R | RECESSED

spot 82 E

 **Cut out**
ø68 mm, ↑ 100 mm

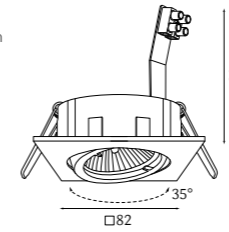

spot 82 R

 **CUT OUT**
ø68 mm, ↑ 100 mm

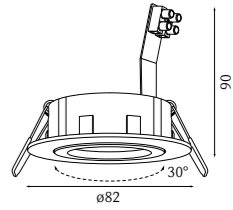

 max. 50W Gu5,3 12V















ACCESSORIES

Gu10 Conversion kit 230V/AC 740024

 max. 50W Gu10/PAR16

LAMP GU10

54P929002495902	LED Gu10 dim	4W	2700K	345lm	36°
54P929002068302	LED Gu10 dim	4W	3000K	345lm	36°

1 TYPE	2 COLOUR	3 ORDER NUMBER	1 TYPE	2 COLOUR	3 ORDER NUMBER
 spot 82 R	 white	740015WS-V1	 spot 82 E	 white	740016WS-V1
	 black	740015SW-V1		 black	740016SW-V1
	 pearl chrome	740015PC		 pearl chrome	740016PC
	 chrome	740015CR		 brushed nickel	740016NG
	 brass	740015MS		 chrome	740016CR
	 brushed nickel	740015NG			
	 bronze	740015BG			

► [Configure online on KATALOG.PLANLICHT.COM](https://www.katalog.planlicht.com)



12V AC/DC

SYSTEME

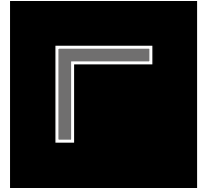

Systems
Systèmes

PROFILLEUCHTEN | PROFILE LUMINAIRES | LUMINAIRES PROFILÉS



P,THIRTY
354

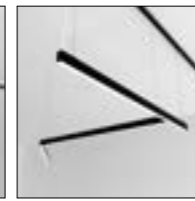

P,FORTY
364



PURE 3
378



SINUS
390

INSETS - DOWNLIGHTS



ANTO+ INSET
372

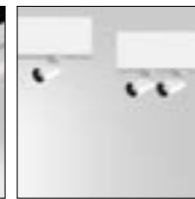

ZENIT INSETS & SEGMENTE
376 & 360



DIFFERENT SHAPES / DIFFUSERS

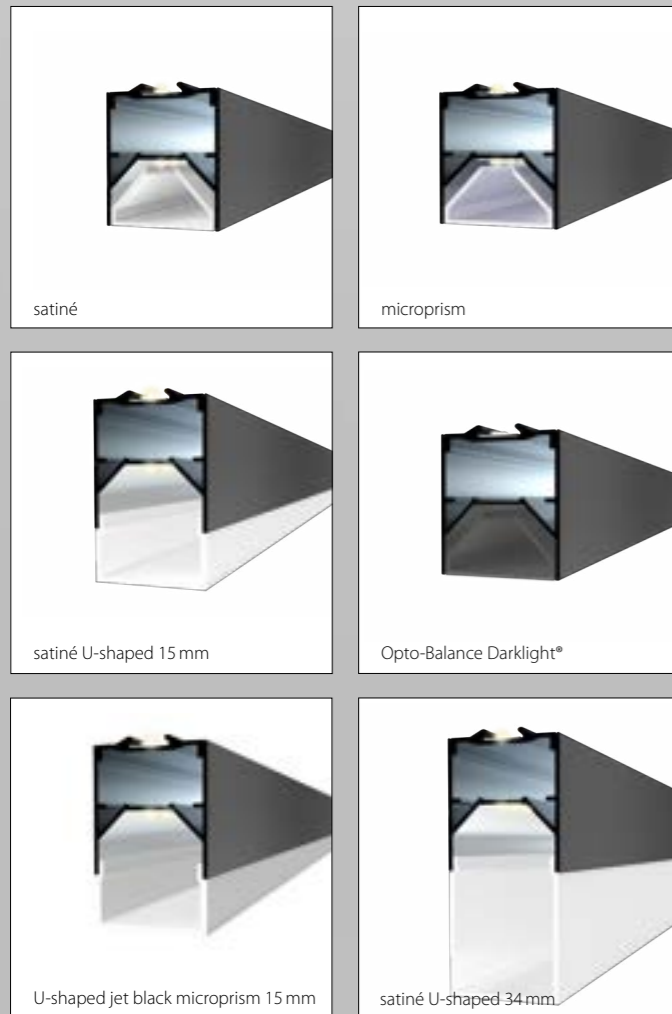

90° CONNECTORS

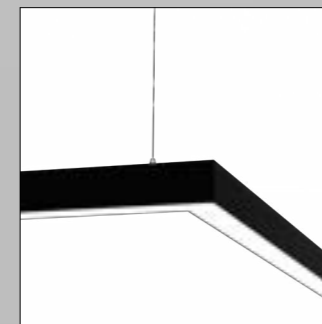

ZENIT XXS SEGMENTS



DIFFERENT HOUSING COLOURS

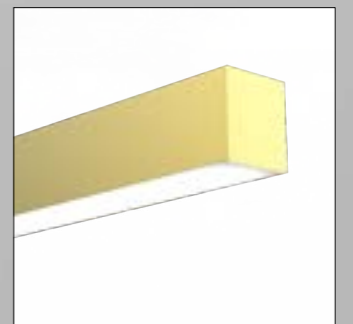

MIX & MATCH MOUNTING TYPES

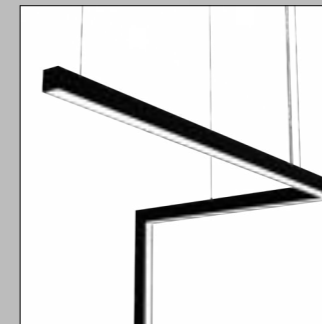

DIFFERENT DIFFUSERS

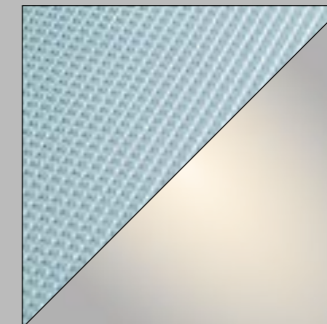

DIFFERENT COLOUR CABLES

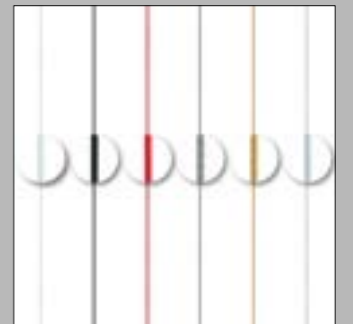

1 MOUNTING

- Surface mounted
- Pendant
- Wall mounted
- Recessed

A
H
W
E

4 DIRECT / INDIRECT

- direct
- direct/indirect

1
2

5 LED

- LF927 2700 K, CRI > 90
- LF930 3000 K, CRI > 90
- LF940 4000 K, CRI > 90
- LF840 4000 K, CRI > 80

927
930
940
840

6 OUTPUT / CONTROL

- low output non-dim (not OBD)
- low output DALI (not OBD)
- high output non-dim (recessed with diffuser 054 & 063 only)
- high output DALI
- very high output non-dim (direct/OBD only)
- very high output DALI (direct/OBD only)

L1
L3
H1
H3
V1
V3

7 OPTIC

- satiné
- microprism*
- U-shaped satiné, 15 mm
- U-shaped satiné, 34 mm
- U-shaped jet black microprism, 15 mm*
- Opto-Balance Darklight® BAP high-gloss black chrome*
- Opto-Balance Darklight® BAP high-gloss copper*
- Opto-Balance Darklight® BAP high-gloss gold*
- Opto-Balance Darklight® BAP high-gloss silver*

S
M
U
Q
V
Z
K
G
B

3 COLOUR

- silver 9006
- white 9016
- black 9005
- RAL of your choice

2 FORM / SIZE

Segment L-Form, horizontal	LFH	Linear segment 2254 mm	225
Segment L-Form, vertical (not H, OBD)	LFV	Linear segment 2344 mm	234
Segment T-Form, horizontal (not W)	TFH	Linear segment 2434 mm	243
Segment X-Form, horizontal (not W)	XFH	Linear segment 2524 mm	252
Linear segment 542 mm (only L1, direct, recessed H1)	054	Linear segment 2614 mm	261
Linear segment 632 mm (only L1, direct, recessed H1)	063	Linear segment 2704 mm	270
Linear segment 722 mm	072	Linear segment 2794 mm	279
Linear segment 812 mm (not very high output)	081	Linear segment 2884 mm	288
Linear segment 902 mm (not very high output)	090	Linear segment 2974 mm	297
Linear segment 992 mm (not di/id, very high output)	099	Linear segment 3064 mm	306
Linear segment 1082 mm (not di/id, very high output)	108	Linear segment 3156 mm	315
Linear segment 1172 mm (not di/id, very high output)	117	Linear segment 3246 mm	324
Linear segment 1262 mm	126	Linear segment 3336 mm	333
Linear segment 1352 mm	135	Linear segment 3426 mm	342
Linear segment 1442 mm	144	Linear segment 3516 mm	351
Linear segment 1532 mm	153	Linear segment 3606 mm	360
Linear segment 1624 mm	162	Linear segment 3696 mm	369
Linear segment 1714 mm	171	Linear segment 3786 mm	387
Linear segment 1804 mm	180	Linear segment 3966 mm	396
Linear segment 1894 mm	189	Linear segment 4056 mm	405
Linear segment 1984 mm	198	Linear segment 4146 mm	414
Linear segment 2074 mm	207	Linear segment 4236 mm	423
Linear segment 2164 mm	216	Linear segment 4326 mm	432

LUMINOUS FLUX (LM) / SYSTEM POWER (W), CRI > 80

4000 K satiné	low output	direct		direct/indirect	
		high output	very high output	low output	high output
542 mm	930 lm / 8 W	-	-	-	-
632 mm	1082 lm / 8,9 W	-	-	-	-
722 mm	1236 lm / 9,8 W	1762 lm / 14 W		2010 lm / 13,5 W	2853 lm / 19,5 W
812 mm	1388 lm / 10,5 W	1981 lm / 15,5 W		2359 lm / 15,5 W	3348 lm / 22 W
902 mm	1541 lm / 11,5 W	2199 lm / 16,5 W		2708 lm / 17 W	3843 lm / 25 W
1262 mm	2151 lm / 15,5 W	3074 lm / 22 W		4103 lm / 27 W	5825 lm / 39 W
1442 mm	2457 lm / 17 W	3512 lm / 25 W		4802 lm / 31 W	6818 lm / 44 W
1714 mm	2914 lm / 22 W	4167 lm / 32 W		5848 lm / 36 W	8304 lm / 52 W
2254 mm	3829 lm / 28 W	5479 lm / 40 W		7352 lm / 49 W	10449 lm / 71 W
3064 mm	5201 lm / 36 W	7445 lm / 52 W		10692 lm / 67 W	15193 lm / 97 W
3606 mm	6113 lm / 44 W	8755 lm / 64 W		12788 lm / 80 W	18174 lm / 116 W
4326 mm	7331 lm / 51 W	10503 lm / 74 W		14992 lm / 95 W	21315 lm / 137 W
LFH	1541 lm / 11,5 W	2199 lm / 16,5 W		2708 lm / 17 W	3843 lm / 25 W
LFV	1236 lm / 9,8 W	1762 lm / 14 W		2206 lm / 14,5 W	3129 lm / 21 W
TFH	1541 lm / 11,5 W	2199 lm / 16,5 W		2708 lm / 17 W	3843 lm / 25 W
XFH	1541 lm / 11,5 W	2199 lm / 16,5 W		2905 lm / 17 W	4119 lm / 26 W

COMPARE COVER 1442 MM, 4000 K, CRI > 80

satiné	2457 lm	3512 lm	4802 lm	6818 lm
microprism	2533 lm	3625 lm	4879 lm	6927 lm
U-shaped satiné (15 mm)	2587 lm	3708 lm	4932 lm	7015 lm
U-shaped satiné (34 mm)	2724 lm	3902 lm	5070 lm	7207 lm
U-shaped jet black microprism	1417 lm	2020 lm	3765 lm	5324 lm
jet black & light	506 lm	723 lm	2851 lm	4029 lm
Opto-Balance Darklight® high-gloss silver	-	1941 lm	3836 lm	5102 lm

OPTIONAL ACCESSORY

PROTECTIVE COVER (INDIRECT)

P30-DIF-ID

LED-board cover, optional, reduces lumen output (max. 3,95%), sold by the metre

P30-1 2 3 4 5 6

P30-W1629016C2940H3S Wall mounted, Linear segment 1624 mm, white, IP20, direct/indirect, 4000 K, CRI > 90, high output DALI, satiné (order sample)

Configure online on KATALOG.PLANLICHT.COM



Down to UGR ≤ 16 | up to 171 lm/W | up to 5316 lm/m | IEC 62471: Blue light hazard: RG ≤ 1 | DALI push switchDIM

PENDANT | WALL | SURFACE

RECESSED

- 01 PROFILE HOUSING**
- P30-PRO1-9006
 - P30-PRO1-9016
 - P30-PRO1-9005

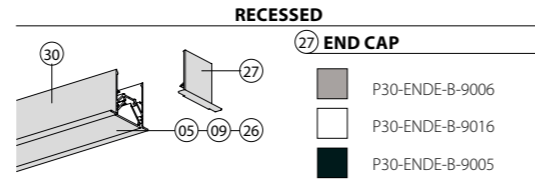
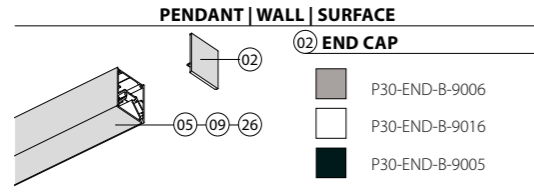

- 30 PROFILE HOUSING**
- P30-PROE-9006
 - P30-PROE-9016
 - P30-PROE-9005

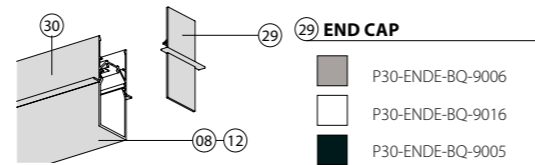
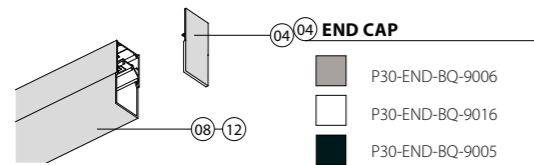
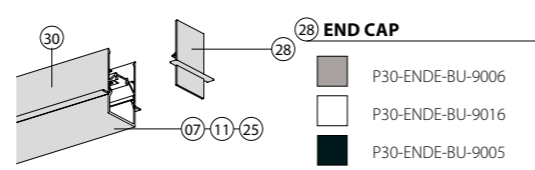
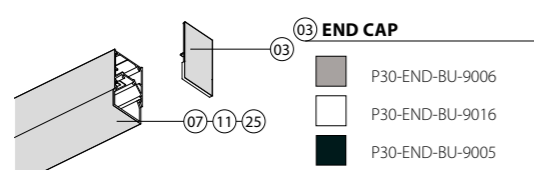

- OPTIC**
- 05** P30-DIF-S (satiné)
 - 32** P30-DIF-J jet black & light
 - 06** P30-DIF-M (microprism)
 - 07** P30-DIF-SU U-shaped satiné (15 mm)
 - 08** P30-DIF-SQ U-shaped satiné (34 mm)
 - 25** P30-DIF-JU jet black microprism (15 mm)
 - 26** P30-OBD-Z Opto-Balance Darklight® BAP high-gloss black chrome
 - 26** P30-OBD-K Opto-Balance Darklight® BAP high-gloss copper
 - 26** P30-OBD-G Opto-Balance Darklight® BAP high-gloss gold
 - 26** P30-OBD-B Opto-Balance Darklight® BAP high-gloss silver

- 09 BLANK COVER (DIRECT)**
- P30-BLI-9006
 - P30-BLI-9016
 - P30-BLI-9005
- Meterware
Sold by the metre
Marchandise vendue au mètre

- 10 BLANK COVER (INDIRECT)**
- P30-BLI2-9006
 - P30-BLI2-9016
 - P30-BLI2-9005
 - P30-BLI2-ALU
- Meterware
Sold by the metre
Marchandise vendue au mètre

- 11 BLANK COVER U-SHAPED (15 MM)**
- P30-BLU-9006
 - P30-BLU-9016
 - P30-BLU-9005
- Meterware
Sold by the metre
Marchandise vendue au mètre

- 12 BLANK COVER U-SHAPED (34 MM)**
- P30-BLQ-9006
 - P30-BLQ-9016
 - P30-BLQ-9005
- Meterware
Sold by the metre
Marchandise vendue au mètre

- 14 WALL MOUNTING BRACKET**
- P30-WAB-M-1
-

- 15 POWER SUPPLY WITH CANOPY**
- P30-EIN-3 0,75 mm² 3-pole
 - P30-EIN-5 0,75 mm² 5-pole
- 1750mm
-

- 16 SUSPENSION CABLE WITH RAPID TENSIONER**
- P30-SEI-150 1500 mm
 - P30-SEI-600 6000 mm

- 17 SEGMENT CONNECTOR**
- P30-LIN

- 18 FEED-THROUGH WIRING FOR BLANK COVER**
- P30-DV-BLI
- Meterware
Sold by the metre
Marchandise vendue au mètre

- 19 CABLE SET**
- P30-DVS
- 5-polig für Dimmung
5-pole for dimming
5 pôles pour gradation

- 20 POWER SUPPLY WITH CANOPY**
- P30-EIN-BLACK 0,75 mm² 5-pole
 - P30-EIN-GOLD 0,75 mm² 5-pole
 - P30-EIN-IRON 0,75 mm² 5-pole
 - P30-EIN-RED 0,75 mm² 5-pole
 - P30-EIN-SILVER 0,75 mm² 5-pole
 - P30-EIN-WHITE 0,75 mm² 5-pole
- 1750 mm
- P30-EIN-BLACK-6M 0,75 mm² 5-pole
 - P30-EIN-GOLD-6M 0,75 mm² 5-pole
 - P30-EIN-RED-6M 0,75 mm² 5-pole
 - P30-EIN-SILVER-6M 0,75 mm² 5-pole
 - P30-EIN-WHITE-6M 0,75 mm² 5-pole
- 6000 mm

- 21 L-CONNECTOR HORIZONTAL**
- Configure on 356

- 22 L-CONNECTOR VERTICAL**
- Configure on 356

- 23 T-CONNECTOR**
- Configure on 356

- 24 X-CONNECTOR**
- Configure on 356

- 31 ID-LED-COVER**
- P30-DIF-ID
- LED-Panelabdeckung, optional, reduziert Lichtleistung, Meterware
LED-board cover, optional, reduces lumen output, sold by the metre
Couverture de panneau LED, en option, réduit la puissance lumineuse, au mètre

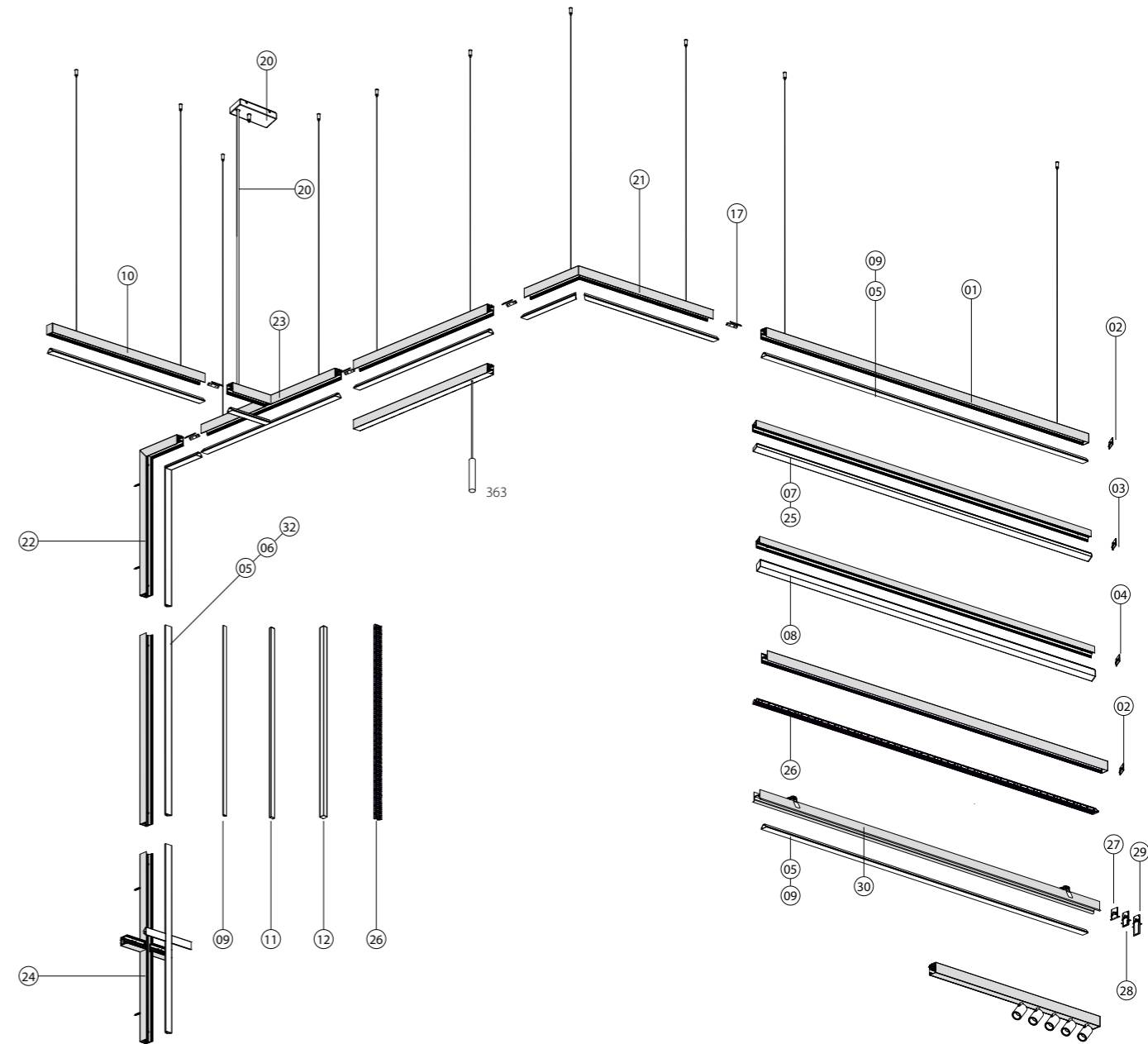

NEW zenit XXS segment spots
for p.thirty

Systeme | Segmente
Systems | Segments
Systèmes | Segment

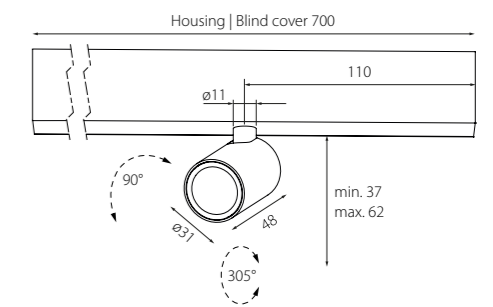
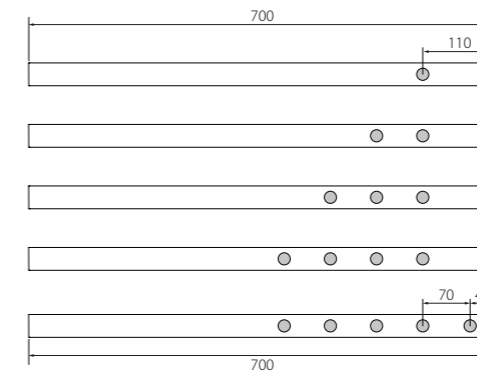
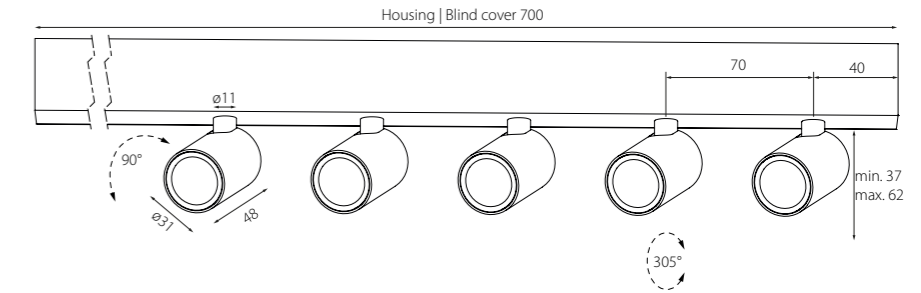
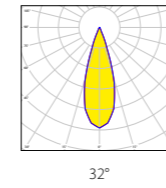
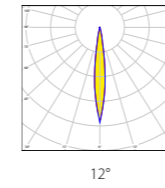

LUMINOUS FLUX (LM) / SYSTEM POWER (W)

	12°					32°				
	1 spot (7W)	2 spots (11,5W)	3 spots (16,5W)	4 spots (21W)	5 spots (26W)	1 spot (7W)	2 spots (11,5W)	3 spots (16,5W)	4 spots (21W)	5 spots (26W)
LF927 2700 K	183 lm	366 lm	549 lm	732 lm	915 lm	272 lm	544 lm	816 lm	1088 lm	1360 lm
LF930 3000 K	189 lm	378 lm	567 lm	756 lm	945 lm	280 lm	560 lm	840 lm	1120 lm	1400 lm
LF940 4000 K	197 lm	394 lm	591 lm	788 lm	985 lm	292 lm	584 lm	876 lm	1168 lm	1460 lm

WEIGHT

	non-dim	DALI
1 spot	720 g	740 g
2 spots	780 g	800 g
3 spots	840 g	860 g
4 spots	900 g	920 g
5 spots	960 g	980 g

based on recessed mounted version

1 PROFILE MOUNTING

- surface
- pendant
- recessed

2 SPOTS

- A** 1 spot
- H** 2 spots
- E** 3 spots
- 4 spots
- 5 spots

3 COLOUR

- silver
 - white
 - black
 - aluminium natural transparent
- spot housing & blank cover
- SI SI**
- WS WS**
- SW SW**
- AT SW**

4 LED

- 2700 K, CRI > 90
- 3000 K, CRI > 90
- 4000 K, CRI > 90

5 CONTROL

- 927** non-dim
- 930** DALI
- 940**

6 BEAM ANGLE

- X1** 12° **1**
- X3** 32° **3**

P30-1 ZBS 2 N 3 4 5 6

P30-AZBS1NATSW927X11 surface mounted p.thirty segment, zenit XXS surface variable, single spot, black tube, aluminium natural transparent spot, black housing & blank cover, 2700 K, CRI > 90, non-dim, 12°, IP 20 (order sample) [Configure online on KATALOG.PLANLICHT.COM](#)

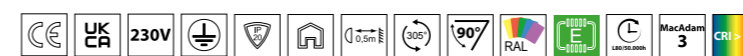

Down to UGR ≤ 16 | IEC 62471: Blue light hazard: RG ≤ 1 | DALI push switchDIM

NEW zenit XXS segment for p.thirty

Systeme | Segmente
Systems | Segments
Systèmes | Segment

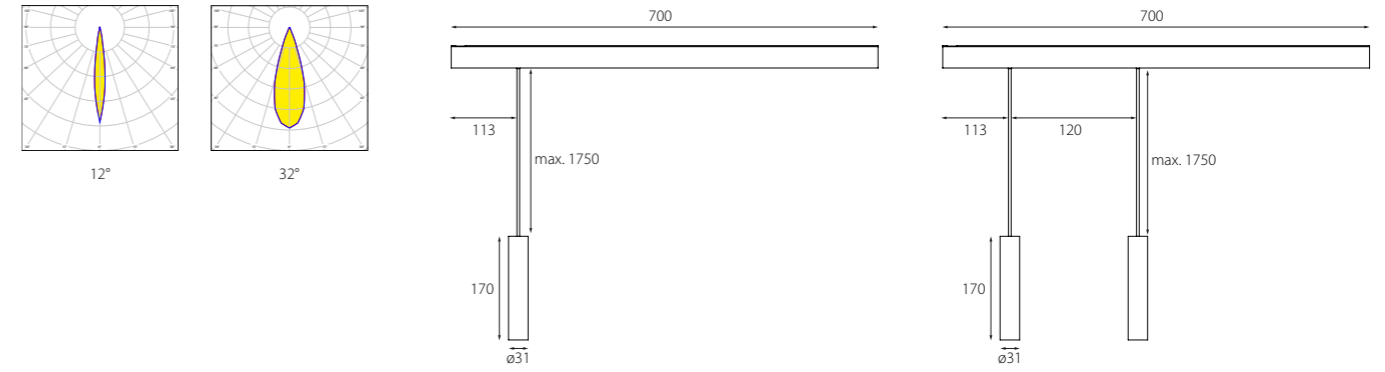
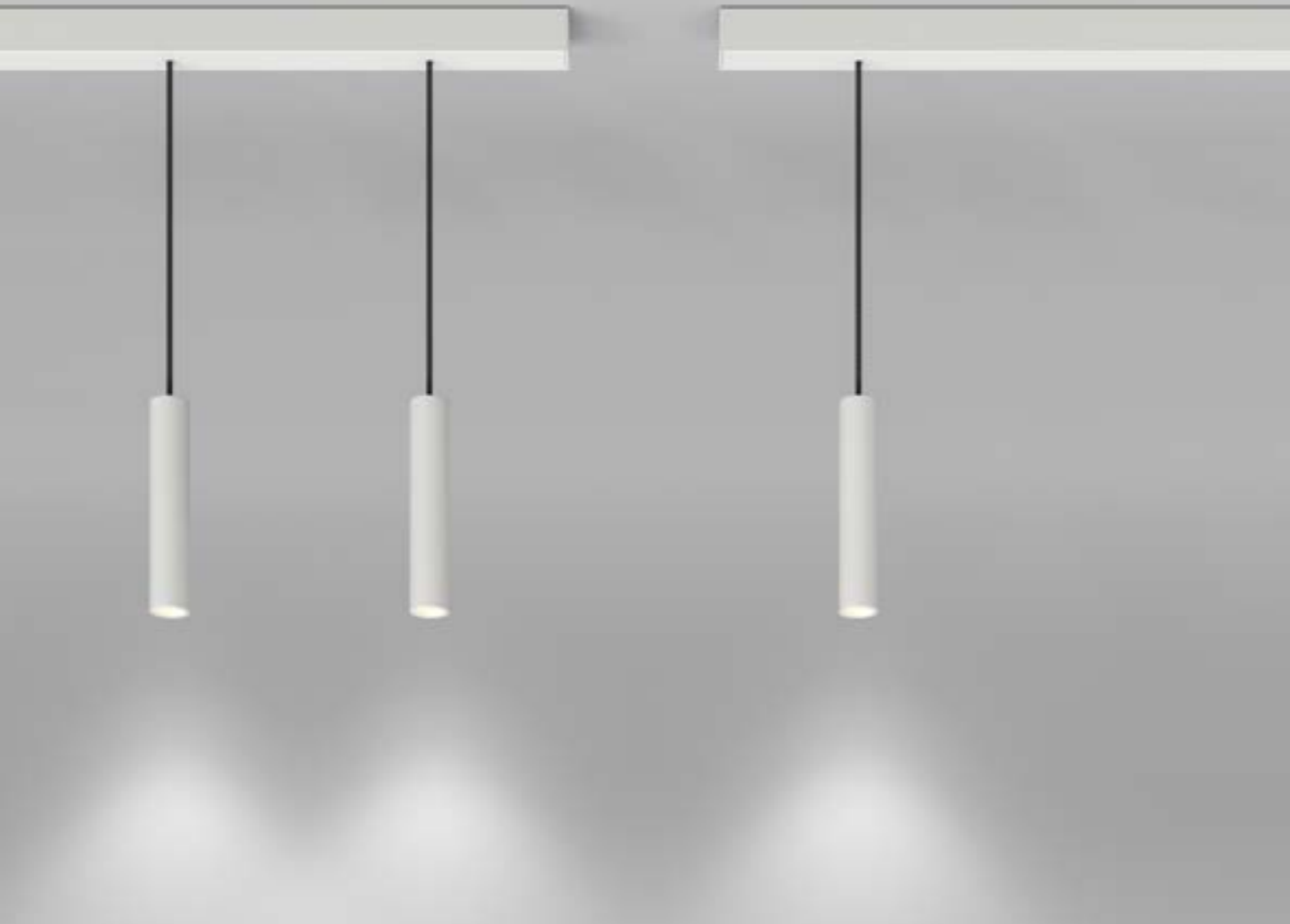

LUMINOUS FLUX (LM) / SYSTEM POWER (W)

	12°		32°	
	1 pendant (7W)	2 pendants (11,5W)	1 pendant (7W)	2 pendants (11,5W)
LF927 2700 K	183lm	366lm	272lm	544lm
LF930 3000 K	189lm	378lm	280lm	560lm
LF940 4000 K	197lm	394lm	292lm	584lm

WEIGHT

	non-dim	DALI
1 pendant	940 g	960 g
2 pendants	1240 g	1260 g

based on recessed mounted version

1 PROFILE MOUNTING

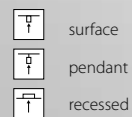

surface
pendant
recessed

2 PENDANTS

A
H
E

1 pendant
2 pendants

1
2

3 COLOUR

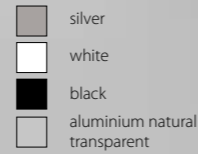

spot
SI
WS
SW
AT

4 LED

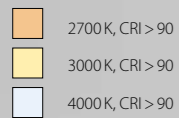

2700 K, CRI > 90
3000 K, CRI > 90
4000 K, CRI > 90

927
930
940

5 CONTROL



non-dim
DALI

X1
X3

6 BEAM ANGLE



12°
32°

1
3

P30-1 ZHS 3 N 4 5 6

P30-AZHS2NATSW927X11 surface mounted p.thirty segment, 2 zenit XXS pendants, black tube, aluminium natural transparent spot, black housing & blank cover, 2700 K, CRI > 90, non-dim, 12°, IP 20 (order sample)

► [Configure online on KATALOG.PLANLICHT.COM](https://www.katalog.planlicht.com)

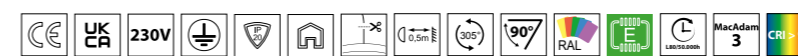

Down to UGR ≤ 16 | IEC 62471: Blue light hazard: RG ≤ 1 | DALI push switchDIM



PROFILE VIEW



P.FUSION

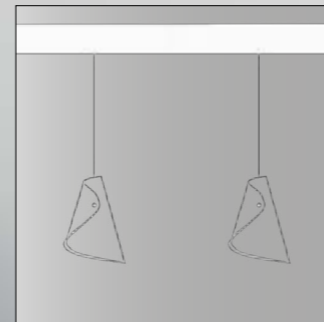

ANTO+ DOWNLIGHT / WALLWASH



ZENIT SPOTLIGHT INSETS



DIFFERENT HOUSING COLOURS

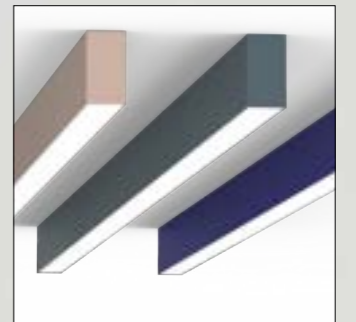

90° / 135° CONNECTORS AND MORE

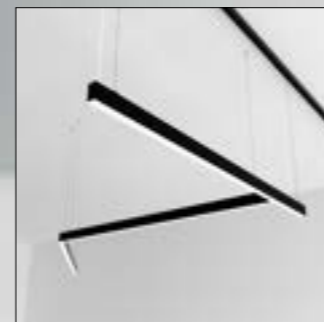

MIX & MATCH MOUNTING TYPES



DIFFERENT DIFFUSERS

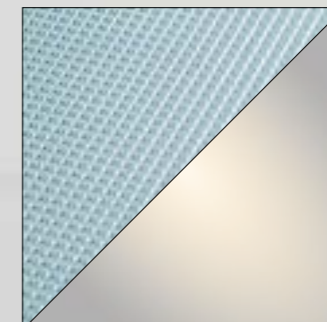

DIFFERENT COLOUR CABLES

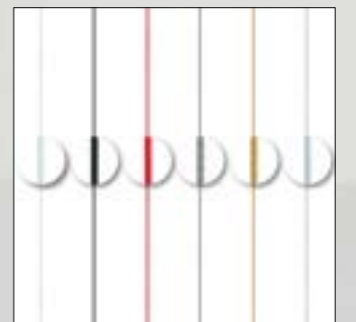



1 OPTIC

- satiné, microprism* or jet-black & light*
- asymmetric or extra comfort*
- RGBW (satiné)

* UGR-optimised, configure online

2 DIRECT/INDIRECT

- direct
- direct/indirect (only pendant & wall)
- indirect (only for RGBW)

- MS**
- AE**
- LE**

3 LED

- 3000 K, CRI > 80
- 4000 K, CRI > 80
- 3000 K, CRI > 90
- 4000 K, CRI > 90
- 2700-6500 K, dynamic white
- RGBW (983/1123/1403 mm & only indirect)

- 830**
- 840**
- 930**
- 940**
- HCL**
- RGB**

4 OUTPUT

- low output
- high output
- dynamic white
- RGBW

- L** 563 mm **056**
- H** 633 mm **063**
- X** 703 mm **070**
- W** 773 mm **077**
- 843 mm **084**
- 913 mm **091**
- 983 mm **098**
- 1053 mm **105**
- 1123 mm **112**
- 1403 mm **140**
- 1683 mm **168**
- 2243 mm **224**

5 SIZE

6 CONTROL

- non-dim
- DALI
- Casambi

- DA**
- CM**

LUMINOUS FLUX (LM) / SYSTEM POWER (W), CRI > 80

satiné (S)	direct				CRI > 90	direct/indirect				CRI > 90
	low output		high output		dynamic white	low output		high output		dynamic white
	3000K	4000K	3000K	4000K		3000K	4000K	3000K	4000K	
563 mm	734lm/7,5W	769lm/7,5W	1278lm/13,5W	1339lm/13,5W	1013lm/14,5W	1817lm/15W	1846lm/15W	3104lm/24W	3222lm/24W	2439lm/26W
633 mm	833lm/8,5W	873lm/8,5W	1453lm/15W	1523lm/15,1W	1153lm/16W	2052lm/17W	2084lm/17W	3508lm/29W	3642lm/29W	2757lm/29W
703 mm	933lm/9,4W	977lm/9,4W	1629lm/16,5W	1706lm/16,3W	1292lm/17W	2286lm/18W	2322lm/18W	3912lm/32W	4061lm/32W	3074lm/31W
773 mm	1032lm/10,5W	1081lm/10,5W	1804lm/17,8W	1890lm/17,8W	1431lm/18,5W	2521lm/19,5W	2561lm/19,5W	4315lm/35W	4480lm/35W	3391lm/34W
843 mm	1131lm/11,5W	1185lm/11,5W	1979lm/19,3W	2073lm/19,3W	1569lm/19,5W	2755lm/21W	2799lm/21W	4719lm/37W	4899lm/37W	3708lm/37W
913 mm	1230lm/12,5W	1289lm/12,5W	2154lm/20,8W	2256lm/20,8W	1708lm/21W	2990lm/23W	3037lm/23W	5122lm/41W	5317lm/41W	4025lm/40W
983 mm	1329lm/13W	1393lm/13W	2328lm/22,4W	2439lm/22,4W	1847lm/23W	3224lm/24W	3275lm/24W	5525lm/44W	5736lm/44W	4342lm/42W
1053 mm	1428lm/14W	1496lm/14W	2502lm/23,8W	2622lm/23,8W	1985lm/24W	3458lm/26W	3513lm/26W	5927lm/47W	6154lm/47W	4659lm/45W
1123 mm	1527lm/15W	1600lm/15W	2677lm/24,2W	2804lm/24,2W	2123lm/25W	3692lm/27W	3751lm/27W	6330lm/49W	6572lm/49W	4975lm/48W
1403 mm	1922lm/17,5W	2014lm/17,5W	3371lm/31,2W	3532lm/31,2W	2674lm/31W	4629lm/34W	4703lm/34W	7938lm/59W	8242lm/59W	6239lm/59W
1683 mm	2316lm/21W	2427lm/21W	4063lm/37,2W	4257lm/37,2W	3223lm/36W	5564lm/40W	5653lm/40W	9544lm/71W	9908lm/71W	7501lm/73W
2243 mm	3101lm/27W	3250lm/27W	5437lm/49W	5697lm/49W	4312lm/48W	7432lm/53W	7552lm/53W	12745lm/97W	13232lm/97W	10016lm/95W

LUMINOUS FLUX (LM) / SYSTEM POWER (W), CRI > 80

microprism (M) *

microprism (M) *	direct				CRI > 90	direct/indirect				CRI > 90
	low output		high output		dynamic white	low output		high output		dynamic white
	3000K	4000K	3000K	4000K		3000K	4000K	3000K	4000K	
563 mm	746lm/7,5W	782lm/7,5W	1299lm/13,5W	1361lm/13,5W	130lm/14,5W	1830lm/15W	1859lm/15W	3126lm/24W	3245lm/24W	2457lm/26W
633 mm	847lm/8,5W	887lm/8,5W	1477lm/15W	1548lm/15,1W	1172lm/16W	2067lm/17W	2099lm/17W	3533lm/29W	3668lm/29W	2777lm/29W
703 mm	948lm/9,4W	993lm/9,4W	1656lm/16,5W	1734lm/16,3W	1313lm/17W	2302lm/18W	2339lm/18W	3940lm/32W	4090lm/32W	3096lm/31W
773 mm	1049lm/10,5W	1099lm/10,5W	1834lm/17,8W	1921lm/17,8W	1455lm/18,5W	2539lm/19,5W	2579lm/19,5W	4346lm/35W	4512lm/35W	3415lm/34W
843 mm	1150lm/11,5W	1205lm/11,5W	2012lm/19,3W	2107lm/19,3W	1595lm/19,5W	2775lm/21W	2819lm/21W	4753lm/37W	4934lm/37W	3735lm/37W
913 mm	1250lm/12,5W	1310lm/12,5W	2190lm/20,8W	2293lm/20,8W	1736lm/21W	3012lm/23W	3059lm/23W	5159lm/41W	5355lm/41W	4054lm/40W
983 mm	1351lm/13W	1416lm/13W	2367lm/22,4W	2479lm/22,4W	1878lm/23W	3247lm/24W	3299lm/24W	5565lm/44W	5777lm/44W	4373lm/42W
1053 mm	1452lm/14W	1521lm/14W	2543lm/23,8W	2665lm/23,8W	2018lm/24W	3483lm/26W	3538lm/26W	5970lm/47W	6198lm/47W	4693lm/45W
1123 mm	1552lm/15W	1626lm/15W	2721lm/24,2W	2850lm/24,2W	2158lm/25W	3719lm/27W	3778lm/27W	6376lm/49W	6619lm/49W	5011lm/48W
1403 mm	1954lm/17,5W	2047lm/17,5W	3427lm/31,2W	3590lm/31,2W	2718lm/31W	4662lm/34W	4737lm/34W	7995lm/59W	8301lm/59W	6284lm/59W
1683 mm	2354lm/21W	2467lm/21W	4130lm/37,2W	4327lm/37,2W	3276lm/36W	5604lm/40W	5694lm/40W	9613lm/71W	9979lm/71W	7555lm/73W
2243 mm	3152lm/27W	3304lm/27W	5527lm/49W	5791lm/49W	4383lm/48W	7486lm/53W	7606lm/53W	12837lm/97W	13327lm/97W	10088lm/95W

* Der angegebene Lichtstrom bezieht sich auf die Leuchte mit klarer mikroprismatischer Abdeckung. Die Leuchte wird mit satinierter Folie zur Erhöhung der Homogenität geliefert (Direkt strahlend: -23% , direkt/indirekt strahlend: -10% Lichtstrom).

* The indicated luminous flux corresponds to the luminaire with a clear microprismatic diffuser. The luminaire is delivered with a satinized-foil for increased homogeneity (direct: -23%, direct-indirect: -10% luminous flux).

Le flux lumineux indiqué correspond au luminaire avec diffuseur microprismatique transparent. Le luminaire est livré avec un film satiné pour optimiser l'homogénéité (direct: -23 %, direct-indirect: -10 % sur le flux lumineux).



LUMINOUS FLUX (LM)/SYSTEM POWER (W), CRI > 80

extra confort (E)

	direct				CRI > 90	direct / indirect				CRI > 90
	low output		high output		dynamic white 2700-6500K	low output		high output		dynamic white 2700-6500K
	3000K	4000K	3000K	4000K		3000K	4000K	3000K	4000K	
563 mm	851 lm / 7,5W	891 lm / 7,5W	-	-	-	1952 lm / 15W	1979 lm / 15W	-	-	-
633 mm	965 lm / 8,5W	1011 lm / 8,5W	-	-	-	2202 lm / 17W	2233 lm / 17W	-	-	-
703 mm	1080 lm / 9,4W	1131 lm / 9,4W	-	-	-	2453 lm / 18W	2489 lm / 18W	-	-	-
773 mm	1195 lm / 10,4W	1252 lm / 10,4W	-	-	-	2705 lm / 19,5W	2743 lm / 19,5W	-	-	-
843 mm	1310 lm / 11,5W	1372 lm / 11,5W	-	-	-	2955 lm / 21W	2997 lm / 21W	-	-	-
913 mm	1425 lm / 12,5W	1492 lm / 12,5W	-	-	-	3206 lm / 23W	3252 lm / 23W	-	-	-
983 mm	1539 lm / 13W	1613 lm / 13W	-	-	-	3457 lm / 24W	3506 lm / 24W	-	-	-
1053 mm	1654 lm / 14W	1733 lm / 14W	-	-	-	3708 lm / 26W	3760 lm / 26W	-	-	-
1123 mm	1769 lm / 15W	1853 lm / 15W	-	-	-	3958 lm / 27W	4015 lm / 27W	-	-	-
1403 mm	2227 lm / 17,5W	2332 lm / 17,5W	-	-	-	4960 lm / 34W	5031 lm / 34W	-	-	-
1683 mm	2683 lm / 21W	2811 lm / 21W	-	-	-	5962 lm / 40W	6048 lm / 40W	-	-	-
2243 mm	3757 lm / 27W	2764 lm / 27W	-	-	-	7961 lm / 53W	8076 lm / 53W	-	-	-

LUMINOUS FLUX (LM)/SYSTEM POWER (W), CRI > 80

asymmetric (A)

	direct				CRI > 90	direct / indirect				CRI > 90
	low output		high output		dynamic white 2700-6500K	low output		high output		dynamic white 2700-6500K
	3000K	4000K	3000K	4000K		3000K	4000K	3000K	4000K	
563 mm	615 lm / 7,5W	644 lm / 7,5W	1070 lm / 13,5W	1121 lm / 13,5W	849 lm / 14,5W	1697 lm / 15W	1721 lm / 15W	2894 lm / 24W	3005 lm / 24W	2275 lm / 26W
633 mm	698 lm / 8,5W	731 lm / 8,5W	1217 lm / 15W	1275 lm / 15W	965 lm / 16W	1915 lm / 17W	1952 lm / 17W	3269 lm / 29W	3394 lm / 29W	2570 lm / 29W
703 mm	781 lm / 9,4W	818 lm / 9,4W	1364 lm / 16,5W	1429 lm / 16,5W	1082 lm / 17W	2133 lm / 18W	2164 lm / 18W	3644 lm / 32W	3784 lm / 32W	2864 lm / 31W
773 mm	864 lm / 10,4W	905 lm / 10,4W	1511 lm / 18W	1583 lm / 18W	1198 lm / 18,5W	2352 lm / 19,5W	2385 lm / 19,5W	4019 lm / 35W	4173 lm / 35W	3159 lm / 34W
843 mm	947 lm / 11,5W	992 lm / 11,5W	1657 lm / 19,5W	1736 lm / 19,5W	1314 lm / 19,5W	2570 lm / 21W	2606 lm / 21W	4394 lm / 37W	4562 lm / 37W	3453 lm / 37W
913 mm	1030 lm / 12,5W	1079 lm / 12,5W	1803 lm / 21W	1890 lm / 21W	1430 lm / 21W	2788 lm / 23W	2828 lm / 23W	4768 lm / 41W	4951 lm / 41W	3748 lm / 40W
983 mm	1113 lm / 13W	1166 lm / 13W	1950 lm / 22W	2043 lm / 22W	1546 lm / 23W	3006 lm / 24W	3049 lm / 24W	5143 lm / 44W	5339 lm / 44W	4042 lm / 42,5W
1053 mm	1196 lm / 14W	1253 lm / 14W	2096 lm / 24W	2196 lm / 24W	1662 lm / 24W	3224 lm / 26W	3270 lm / 26W	5517 lm / 47W	5728 lm / 47W	4336 lm / 45,5W
1123 mm	1279 lm / 15W	1340 lm / 15W	2242 lm / 24W	2349 lm / 24W	1778 lm / 25W	3442 lm / 27W	3491 lm / 27W	5891 lm / 49W	6116 lm / 49W	4630 lm / 47,6W
1403 mm	1610 lm / 17,5W	1686 lm / 17,5W	2823 lm / 31W	2958 lm / 31W	2239 lm / 31W	4313 lm / 34W	4375 lm / 34W	7385 lm / 59W	7668 lm / 59W	5804 lm / 59W
1683 mm	1940 lm / 21W	2032 lm / 21W	3403 lm / 37W	3565 lm / 37W	2699 lm / 36W	5184 lm / 40W	5259 lm / 40W	8877 lm / 71W	9216 lm / 71W	6977 lm / 73,1W
2243 mm	2597 lm / 27W	2721 lm / 27W	4553 lm / 49W	4771 lm / 49W	3611 lm / 48W	6923 lm / 53W	7023 lm / 53W	11853 lm / 97W	12306 lm / 97W	9315 lm / 95,3W

RGBW



indirect

400 lm/m 6,1 W/m

983 / 1123 / 1403 mm

figures lm & W in 3000K (830)

EMERGENCY ADD-ONS



P40-NOT-3H-LED

3h battery

P40-NOT-ZVS-INOTEC

INOTEC monitoring component for central current supply (direct 983 mm / direct/indirect 1403 mm only)



J. Mayer H. und Partner, Architekten MBB - Fotos: David Franck, Ostfildern

J. Mayer H. und Partner, Architekten MBB - Fotos: David Franck, Ostfildern

PENDANT | WALL |
SURFACE

01 PROFILE HOUSING

H=82mm	H=70mm
P40-PRO1-9006	P40-PRO0-9006
P40-PRO1-9016	P40-PRO0-9016
P40-PRO1-9005	P40-PRO0-9005

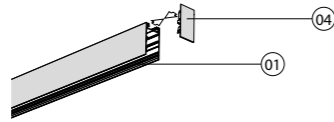

RECESSED FRAME

02 PROFILE HOUSING

P40-PROE-9006
P40-PROE-9016
P40-PROE-9005

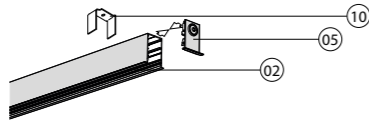

RECESSED FRAME-
LESS

03 PROFILE HOUSING

P40-PROF-ALUB

Meterware; Maximale Teilprofillänge: 4500 mm
Sold by the metre; maximum section length: 4500 mm
Marchandise vendue au mètre; longueur de section max. 4500 mm

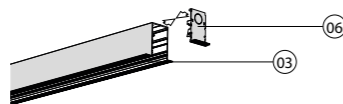

07 BLANK COVER DIRECT

P40-BLI-9006
P40-BLI-9016
P40-BLI-9005

08 BLANK COVER INDIRECT

P40-BL2-9006
P40-BL2-9016
P40-BL2-9005

Meterware
Sold by the metre
Marchandise vendue au mètre

10 RECESSED-MOUNT BRACKET

P40-MOB-E-1

1x per max. 900mm
min. 2 pcs.

10-40mm

11 RECESSED-MOUNT BRACKET

P40-MOB-F-1

1x per max. 900mm
min. 2 pcs.

10-50mm

Inklusive Schrauben
Screws included
Vis incluses

13 BRIDGING FOR LIGHT SOURCES

P40-DV-R

max. 2250mm

14 SEGMENT CONNECTOR

P40-LIN

Paarweise; Inklusive Inbusschrauben
In pairs; Hexagon socket screws included
Paire; Vis à six pans creux incluses

16 MITRE CUT

horizontal	P40-HOR-90	90°
	P40-HOR-135	135°
vertical	P40-VER-90	90°

Inklusive Verbinder
Connectors included
Connecteurs inclus

17 CROSS CONNECTOR

P40-KV1	90°	pendant/surface
P40-KVE	90°	recessed FRAME
P40-KVF	90°	recessed FRAMELESS

25C CADDYCLIPS (T24)

P40-SEI-150-CC	1500 mm
----------------	---------

04 END CAP

H=82mm	H=70mm
P40-END1-9006	P40-END0-9006
P40-END1-9016	P40-END0-9016
P40-END1-9005	P40-END0-9005

05 END CAP

P40-ENDE-9006
P40-ENDE-9016
P40-ENDE-9005

06 END CAP

P40-ENDF-ALUB

09 DIFFUSER

P40-DIF-S (satiné)
P40-DIF-J (jet-black & light)
P40-DIF-M (microprism)
P40-DIF-E (extra comfort)
P40-DIF-A-BLACK (asymmetric)

Meterware; Maximale Teilprofillänge: 4500 mm
Sold by the metre; maximum section length: 4500 mm
Marchandise vendue au mètre; longueur de section max. 4500 mm

12 FEED-TROUGH WIRING FOR BLANK COVER

P40-DV-BLI

Meterware
Sold by the metre
Marchandise vendue au mètre

15 3-PHASE TRACK

1100mm	2100mm
P40-3PH-110-AL	P40-3PH-210-AL
P40-3PH-110-WS	P40-3PH-210-WS
P40-3PH-110-SW	P40-3PH-210-SW

Inkl. Einspeisung u. Endabdeckung
Power supply and end cap included
Alimentation et embout inclus

18 T-CONNECTOR

P40-TV1	90°	pendant/surface
P40-TVE	90°	recessed FRAME
P40-TVF	90°	recessed FRAMELESS

26 LIGHT SOURCES

367

19 WALL BRACKET

P40-WAB-E-1	19A
P40-WAB-M-1	19B

22 POWER SUPPLY WITH CANOPY

P40-EIN-3	3x0,75 mm ²	1750 mm
P40-EIN-5	5x0,75 mm ²	
P40-EIN-7	7x0,75 mm ²	
P40-EIN-7-Q1,5	7x1,50 mm ²	

25 SUSPENSION CABLES

P40-SEI-150	1500 mm
P40-SEI-600	6000 mm

1x per max. 2000 mm
min. 2 pcs.

20 CONNECTION TERMINAL

P40-ANS5	5-pole
P40-ANS7	7-pole

Inkl. Zubehör; eine Klemme pro Einspeisung; Klemmbereich 0,75 - 2,5 mm²
Accessories incl; one terminal per power supply; clamping range 0.75 - 2.5 mm²
Accessoires inclus; un bornier par alimentation; plage de serrage 0.75 - 2.5 mm²

23 POWER SUPPLY WITH DESIGN CANOPY

P40-EIN-5-DB	5x0,75 mm ²	1750 mm
--------------	------------------------	---------

25A RAPID TENSIONER

P40-SEI-150	1500 mm
P40-SEI-600	6000 mm

21 CONNECTION SET

P40-DVS	7-pole for dimming
---------	--------------------

24 POWER FEED 3-PHASE-TRACK

P40-EIN-3PH-WS	3x1,50 mm ²
P40-EIN-3PH-SW	3x1,50 mm ²

2500mm
Inkl. 3-Phasen-Universaladapter
3 phase universal adapter incl.
adaptateur universel 3 phases inclus

25B RAPID TENSIONER FOR INCLINED CEILINGS

P58-SEI-200	1500 mm
P58-SEI-600	6000 mm

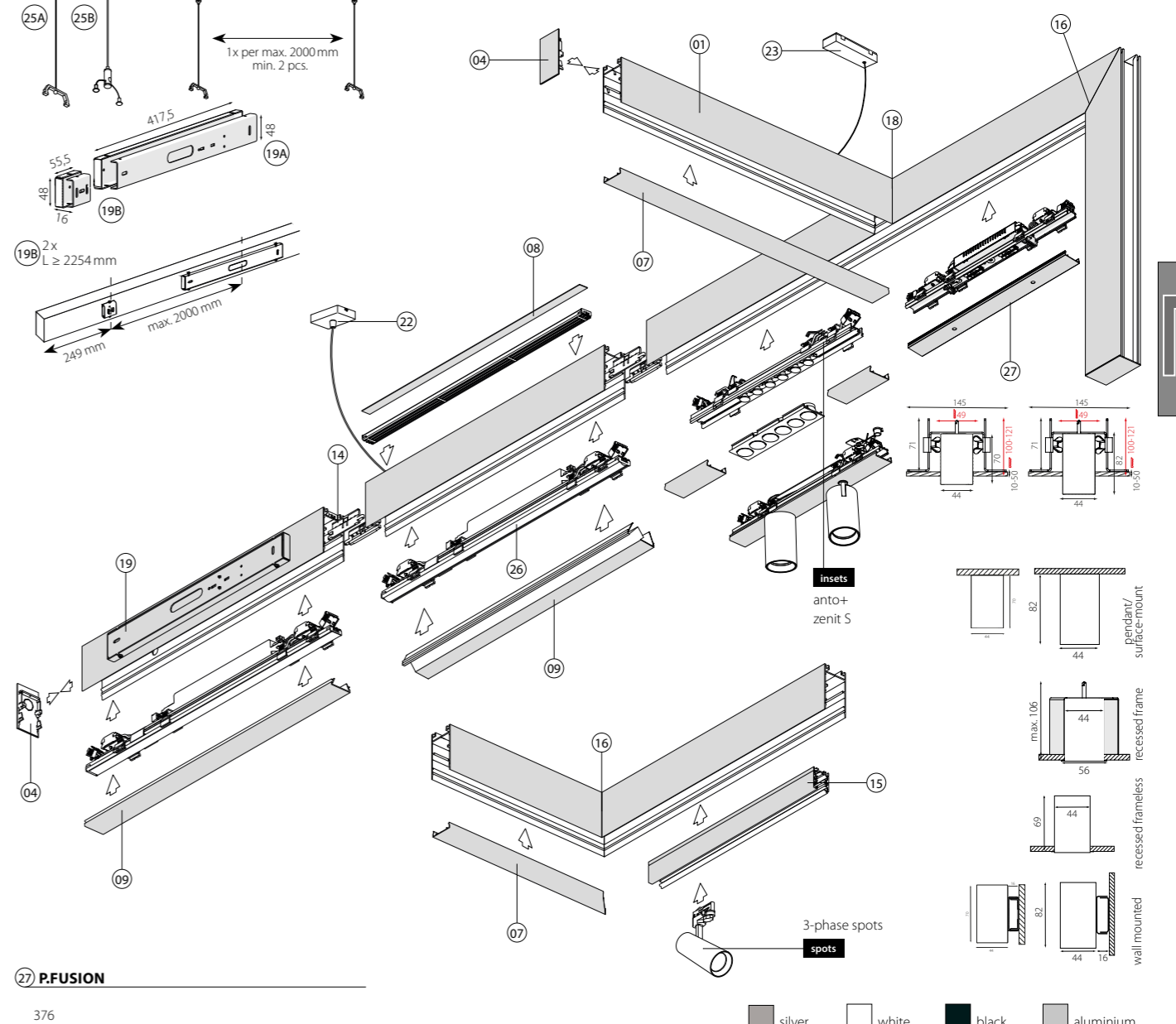

27 P.FUSION

376

silver white black aluminium

anto+ inset for p.forty & pure 3 systems

Systeme | Downlight Inset p.forty & pure 3
Systems | Downlight Inset p.forty & pure 3
Systèmes | Downlight Inset p.forty & pure 3

ANTO+ INSET FOR P.FORTY & PURE 3 | SYSTEMS

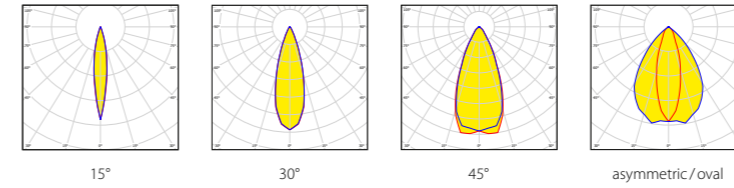

LUMINOUS FLUX (LM) / ANTO+ / LENS TUBE SILVER MATTE, CRI > 90

	2700 K				3000 K				4000 K				dynamic white			
	15°	30°	45°	asym.	15°	30°	45°	asym.	15°	30°	45°	asym.	15°	30°	45°	asym.
2 spots	241 lm	220 lm	184 lm	193 lm	246 lm	224 lm	188 lm	197 lm	256 lm	234 lm	196 lm	205 lm	-	-	-	-
4 spots	478 lm	435 lm	365 lm	382 lm	487 lm	444 lm	372 lm	390 lm	507 lm	463 lm	389 lm	406 lm	-	-	-	-
6 spots	737 lm	672 lm	564 lm	590 lm	752 lm	685 lm	575 lm	602 lm	783 lm	714 lm	600 lm	627 lm	-	-	-	-
8 spots	990 lm	901 lm	756 lm	791 lm	1008 lm	919 lm	770 lm	807 lm	1050 lm	958 lm	805 lm	840 lm	-	-	-	-
12 spots	1526 lm	1391 lm	1167 lm	1221 lm	1557 lm	1418 lm	1190 lm	1246 lm	1621 lm	1478 lm	1242 lm	1298 lm	-	-	-	-
18 spots	2211 lm	2016 lm	1692 lm	1770 lm	2256 lm	2055 lm	1725 lm	1806 lm	2349 lm	2142 lm	1800 lm	1181 lm	1128 lm	1028 lm	863 lm	903 lm
30 spots	3685 lm	3360 lm	2820 lm	2950 lm	3760 lm	3425 lm	2875 lm	3010 lm	3915 lm	3570 lm	3000 lm	3135 lm	1880 lm	1713 lm	1438 lm	1505 lm

COMPARE LENS TUBE ANTO+ / SURFACE 18 SPOTS

lens tube	4000 K			
	15°	30°	45°	asym.
high-gloss silver	2511 lm	2307 lm	2112 lm	2303 lm
silver matte	2349 lm	2142 lm	1800 lm	1881 lm
high-gloss gold	2496 lm	2289 lm	2109 lm	2277 lm
high-gloss copper	2472 lm	2280 lm	2106 lm	2213 lm
white (RAL 9016)	2451 lm	2256 lm	1965 lm	2150 lm
black (RAL 9005)	2250 lm	2040 lm	1590 lm	1587 lm
glaring gold	2310 lm	2094 lm	1683 lm	1746 lm
capital copper	2286 lm	2067 lm	1608 lm	1665 lm
gunnery grey	2340 lm	2106 lm	1689 lm	1755 lm
high-gloss black chrome	2238 lm	2056 lm	1883 lm	2053 lm

SYSTEM POWER (W) / WEIGHT

	non dim DALI		dyn. white		Inset p.forty		Inset pure 3	
					non-dim	DALI/HCL	non-dim	DALI/HCL
2 spots	4,1 W				0,1 kg		0,1 kg	
4 spots	7,7 W				0,1 kg		0,1 kg	
6 spots	10 W				0,3 kg	0,4 kg	0,3 kg	0,4 kg
8 spots	14 W				0,5 kg	0,5 kg	0,5 kg	0,5 kg
12 spots	19 W	11 W			0,5 kg	0,6 kg	0,6 kg	0,6 kg
18 spots	29 W	17 W			0,6 kg	0,6 kg	0,6 kg	0,7 kg
30 spots	47 W	27 W			1,0 kg	1,0 kg	1,0 kg	1,0 kg

VARIATIONS ANTO+ INSETS

	MEDIUM OUTPUT		DYNAMIC
	non-dim	DALI	WHITE
2 spots	●	-	-
4 spots	●	-	-
6 spots	●*	●*	-
8 spots	●*	●*	-
12 spots	●*	●*	●*
18 spots	●	●	●
30 spots	●	●	●

* blind cover

1 SPOTS

- 2 spots
- 4 spots
- 6 spots (2x100mm Blind Cover)
- 8 spots (2x100mm Blind Cover)
- 12 spots (2x100mm Blind Cover)
- 18 spots
- 30 spots

2 LENS TUBE COLOUR

- 02** high-gloss silver
- 04** silver matte
- 06** high-gloss gold
- 08** high-gloss cooper
- 12** white (RAL 9016)*
- 18**
- 30**

3 MASK COLOUR

- N** high-gloss silver
- D** silver matte
- R** high-gloss gold
- Y** high-gloss cooper
- Z NEW** white (RAL 9016)
- B** black (RAL 9005)
- P** glaring gold
- G** capital cooper
- K** gunnery grey
- W** high gloss black chrome (for p.forty only)

4 LED

- 927** 2700 K, CRI > 90
- 930** 3000 K, CRI > 90
- 940** 4000 K, CRI > 90
- HCL** 2700-6500 K, dynamic white, CRI > 90

5 OUTPUT

- M** medium output
- X** dynamic white

6 DIM

- 1** non-dim
- 3** DALI

7 BEAM ANGLE

- 1** 15°
- 3** 30°
- 4** 45°
- A** asymmetric/oval

P-A 1-2-3-4-5-6-7

P-A18-PZ940M14 Inset 18 spots, for p.forty/lens tube silver matte, mask high gloss black chrome, 4000 K, CRI > 90, medium output, non-dim, beam angle 45° (order sample)

► Configure online on KATALOG.PLANLICHT.COM



Down to UGR ≤ 16 | up to 99 lm/W | IEC 62471: Blue light hazard: RG ≤ 1 | DALI switchDIM

ANTO+ INSET FOR P.FORTY & PURE 3 | SYSTEMS

COMPARE LENS TUBES / ANTO+ INSET 18 SPOTS

lens tube	2700 K				3000 K				4000 K				dynamic white			
	15°	30°	45°	asym.	15°	30°	45°	asym.	15°	30°	45°	asym.	15°	30°	45°	asym.
silver matte	2211 lm	2016 lm	1692 lm	1770 lm	2256 lm	2055 lm	1725 lm	1806 lm	2349 lm	2142 lm	1800 lm	1881 lm	1128 lm	1028 lm	863 lm	903 lm
high-gloss silver	2364 lm	2169 lm	1986 lm	2124 lm	2412 lm	2211 lm	2025 lm	2166 lm	2511 lm	2307 lm	2112 lm	2303 lm	1206 lm	1106 lm	1013 lm	1083 lm
white 9016	2307 lm	2124 lm	1848 lm	1944 lm	2352 lm	2166 lm	1884 lm	1983 lm	2451 lm	2256 lm	1965 lm	2150 lm	1177 lm	1083 lm	943 lm	991 lm
black 9005	2118 lm	1920 lm	1497 lm	1494 lm	2160 lm	1959 lm	1527 lm	1524 lm	2250 lm	2040 lm	1590 lm	1587 lm	1080 lm	979 lm	763 lm	762 lm
high-gloss gold	2349 lm	2154 lm	1983 lm	2121 lm	2397 lm	2196 lm	2022 lm	2163 lm	2496 lm	2289 lm	2109 lm	2277 lm	1198 lm	1097 lm	1011 lm	1082 lm
high gloss copper	2325 lm	2145 lm	1983 lm	2067 lm	2373 lm	2187 lm	2022 lm	2109 lm	2472 lm	2280 lm	2106 lm	2213 lm	1186 lm	1094 lm	1011 lm	1054 lm
glaring gold	2172 lm	1971 lm	1584 lm	1644 lm	2214 lm	2010 lm	1617 lm	1677 lm	2310 lm	2094 lm	1683 lm	1746 lm	1108 lm	1005 lm	808 lm	838 lm
capital copper	2151 lm	1944 lm	1512 lm	1566 lm	2193 lm	1983 lm	1542 lm	1596 lm	2286 lm	2067 lm	1608 lm	1665 lm	1097 lm	991 lm	771 lm	799 lm
gunnery grey	2202 lm	1980 lm	1590 lm	1650 lm	2247 lm	2019 lm	1623 lm	1683 lm	2340 lm	2106 lm	1689 lm	1755 lm	1123 lm	1010 lm	811 lm	842 lm
high gloss black chrome	2244 lm	2043 lm	1716 lm	1803 lm	2289 lm	2085 lm	1749 lm	1839 lm	2385 lm	2172 lm	1824 lm	1914 lm	1144 lm	1042 lm	875 lm	920 lm



Nobelstyle Graz, Foto: Alexander Kuenzel



Nobelstyle Graz, Foto: Alexander Kuenzel

zenit S inset & p.fusion for p.forty & pure 3 systems

Systeme | Downlight Inset p.forty & pure 3
Systems | Downlight Inset p.forty & pure 3
Systèmes | Downlight Inset p.forty & pure 3



1 SPOTS		2 TUBE COLOUR		3 HOUSING COLOUR	
1 spot	1	gold	G	white	W
2 spots	2	black	S	black	S
4 BLANK COVER		5 LED		6 OUTPUT	
silver	SI	3000K, CRI > 80	830	low output	L
white	WS	4000K, CRI > 80	840	high output	H
black	SW	2700K, CRI > 90	927		
		3000K, CRI > 90	930		
		3500K, CRI > 90	935		
		4000K, CRI > 90	940		
7 CONTROL		8 BEAM			
non-dim	1	16°	1		
DALI	3	23°	2		
		40°	4		

P-Z 1 S 2 3 4 5 6 7 8

P-Z25-GSW5940H32 2 spots black, tube colour gold, black housing, white blank cover, CRI > 90, 4000K, high output, DALI, 23° (order sample)

➔ [Configure online on KATALOG.PLANLICHT.COM](#)

ZENIT S INSET & P.FUSION FOR P.FORTY & PURE 3 SYSTEMS | SYSTEMS

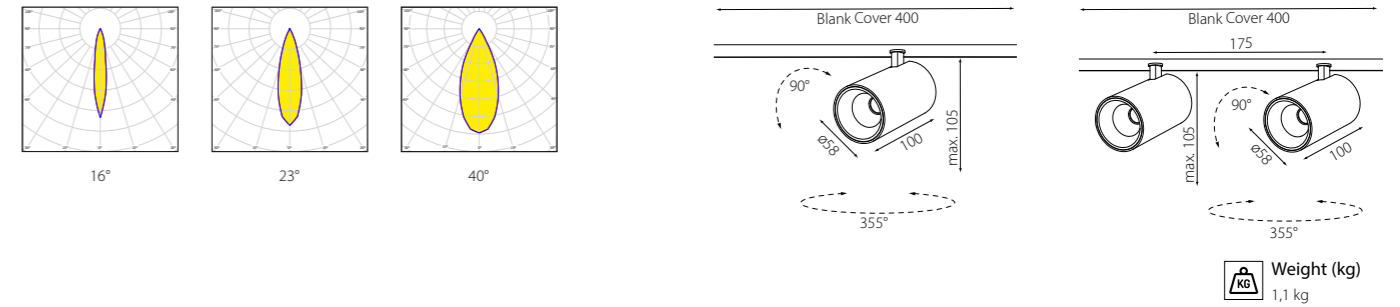

LUMINOUS FLUX (LM) / SYSTEM POWER (W)*

	low output (7,3W)						high output (11W)					
	16°		23°		40°		16°		23°		40°	
	gold	black	gold	black	gold	black	gold	black	gold	black	gold	black
LF830 3000K	820lm	796lm	784lm	761lm	768lm	746lm	1161lm	1127lm	1112lm	1079lm	1088lm	1056lm
LF840 4000K	859lm	834lm	825lm	801lm	803lm	779lm	1217lm	1181lm	1172lm	1138lm	1139lm	1106lm
LF927 2700K	644lm	625lm	623lm	605lm	609lm	591lm	913lm	887lm	881lm	855lm	862lm	837lm
LF930 3000K	672lm	653lm	646lm	627lm	631lm	613lm	933lm	906lm	903lm	877lm	878lm	852lm
LF935 3500K	704lm	683lm	679lm	659lm	660lm	641lm	987lm	958lm	952lm	924lm	925lm	898lm
LF940 4000K	713lm	692lm	686lm	666lm	667lm	647lm	988lm	960lm	943lm	916lm	921lm	895lm

* figures per single spot

OPTIONAL ACCESSORY

Honeycomb glare protection	S10-BLE-58
Oval spot lens	S10-OZL-58
Clear protective glass	S10-SGL-58
Blur glass	S10-WGL-58



Reflektortausch werkzeuglos möglich.
Passive Kühlung. Komplettrahler inklusive Reflektor und Converter.
Replacement of the reflector without any tools.
Passive cooling. Complete spotlight including reflector and converter.
Remplacement du réflecteur sans outil.
Refroidissement passif. Projecteur complet incluant réflecteur et convertisseur.

NEW

P.FUSION FOR P.FORTY & PURE 3 (ONLY FOR SURFACE AND RECESSED - MOUNTED PROFILES (L=400MM))

1 QUANTITY		2 BLANK COVER		3 TECHNOLOGY/OUTPUT	
	1	white	WS	High voltage (230V AC)	HV
	2	black	SW	Constant current	CC*
		silver	SI	* 5 - 30W, 250/400/550/700mA via dip-switch	
4 CONTROL					
non-dim	1				
DALI	3				
P-FSN 1 2 3 4					
P-FSN2WSHV1		p.forty fusion, 2 cable grommets, symmetrical, blank cover white, high voltage, non-dim (order sample)			

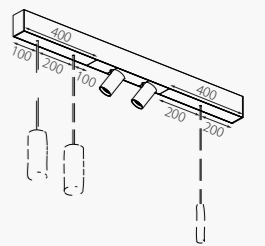

Down to UGR ≤ 16 | up to 118lm/W | IEC 62471: Blue light hazard: RG ≤ 1 | DALI switchDIM



FUSION

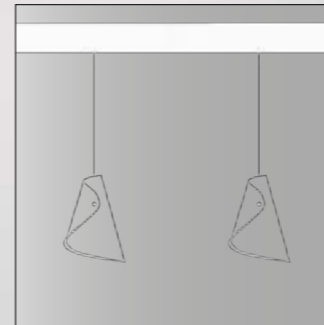

TRIFLECT INSETS

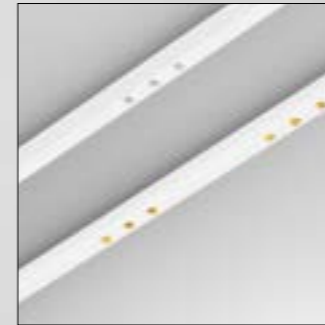

ANTO+ DOWNLIGHT / WALLWASH



ZENIT XS/S SPOTLIGHT INSETS



RGB-W



90° CONNECTORS



DIFFERENT SINUS CURVES



DIFFERENT DIFFUSERS

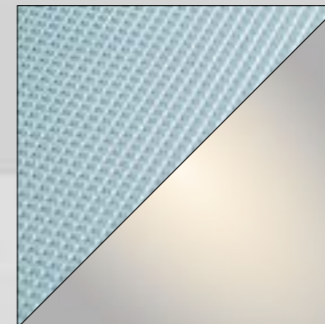

DIFFERENT HOUSING COLOURS



DIFFERENT COLOUR CABLES

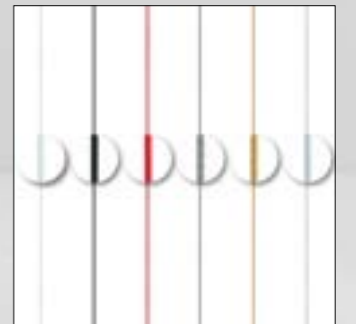

PURE 3 | SYSTEMS

LUMINOUS FLUX (LM)/SYSTEM POWER (W), CRI > 80

BAP louvre (BE)	direct				CRI > 90	direct / indirect				CRI > 90
	low output		high output		dynamic white	low output		high output		dynamic white
	3000 K	4000 K	3000 K	4000 K	2700-6500 K	3000 K	4000 K	3000 K	4000 K	2700-6500 K
1125 mm	1607 lm / 16W	1692 lm / 16W	2853 lm / 28W	3002 lm / 28W	1968 lm / 23W	3612 lm / 28W	3802 lm / 28W	6436 lm / 51W	6774 lm / 51W	4288 lm / 44W
1405 mm	2069 lm / 19W	2168 lm / 19W	3602 lm / 34W	3792 lm / 34W	2402 lm / 29W	4639 lm / 37W	4884 lm / 37W	8182 lm / 67W	8613 lm / 67W	5482 lm / 54W

LUMINOUS FLUX (LM)/SYSTEM POWER (W), CRI > 80

asymmetric (AE)	direct				CRI > 90	direct / indirect				CRI > 90
	low output		high output		dynamic white	low output		high output		dynamic white
	3000 K	4000 K	3000 K	4000 K	2700-6500 K	3000 K	4000 K	3000 K	4000 K	2700-6500 K
564 mm	696 lm / 9W	722 lm / 9W	1332 lm / 16,5W	1409 lm / 16,5W	814 lm / 13W	1732 lm / 15W	1834 lm / 15W	3341 lm / 30W	3526 lm / 30W	2107 lm / 22W
704 mm	882 lm / 10W	925 lm / 10W	1676 lm / 19W	1765 lm / 19W	1021 lm / 15W	2163 lm / 18,5W	2290 lm / 18,5W	4175 lm / 37W	4405 lm / 37W	2632 lm / 28W
844 mm	1045 lm / 13W	1091 lm / 13W	2016 lm / 24W	2122 lm / 24W	1228 lm / 18,5W	2595 lm / 22W	2747 lm / 22W	5008 lm / 45W	5284 lm / 45W	3158 lm / 34W
984 mm	1240 lm / 14W	1302 lm / 14W	2345 lm / 27W	2469 lm / 27W	1429 lm / 21W	3026 lm / 26W	3203 lm / 26W	5842 lm / 52W	6163 lm / 52W	3683 lm / 39W
1124 mm	1426 lm / 16W	1500 lm / 16W	2695 lm / 30W	2836 lm / 30W	1642 lm / 23W	3468 lm / 29W	3650 lm / 29W	6688 lm / 58W	7039 lm / 58W	4216 lm / 44W
1404 mm	1764 lm / 19W	1857 lm / 19W	3357 lm / 37W	3534 lm / 37W	2045 lm / 29W	4339 lm / 38W	4643 lm / 38W	8360 lm / 76W	8864 lm / 76W	5273 lm / 57W
1684 mm	2151 lm / 22W	2265 lm / 22W	3999 lm / 44W	4208 lm / 44W	2436 lm / 34W	5159 lm / 45W	5431 lm / 45W	9985 lm / 90W	10509 lm / 90W	6294 lm / 68W

RGBW



direct satiné

260 lm / m 5,7 W / m

direct/indirect satiné

660 lm / m 11 W / m
563 / 703 / 843 / 983 / 1123 / 1403 mm

indirect

400 lm / m 6,1 W / m
983 / 1123 / 1403 mm

figures lm & W in 3000 K (830)

EMERGENCY ADD-ONS



P33-NOT-3H-LED

3h battery

P33-NOT-ZVS-INOTEC

INOTEC monitoring component for central current supply (direct 983 mm / direct/indirect 1403 mm only)



Administration de la nature et des forêts, Foto: Lukas Huneke

PENDANT | WALL |
SURFACE

- 01 PROFILE HOUSING**
- P33-PRO1-9006
 - P33-PRO1-9016
 - P33-PRO1-9005

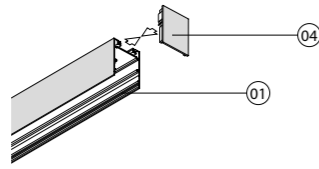

RECESSED FRAME

- 02 PROFILE HOUSING**
- P33-PROE-9006
 - P33-PROE-9016
 - P33-PROE-9005

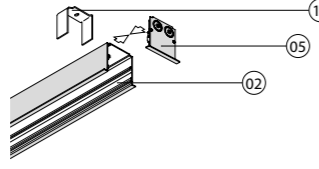

RECESSED FRAME-
LESS

- 03 PROFILE HOUSING**
- P33-PROF-ALUB
- Sold by the metre; maximum section length: 4500 mm
Meterware; Maximale Teilprofillänge: 4500 mm
Marchandise vendue au mètre; longueur de section max. 4500 mm

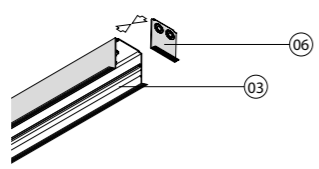

- 07 BLANK COVER DIRECT**
- P33-BLI-9006
 - P33-BLI-9016
 - P33-BLI-9005

- 08 BLANK COVER INDIRECT**
- P33-BL2-9006
 - P33-BL2-9016
 - P33-BL2-9005
- Sold by the metre
Meterware
Marchandise vendue au mètre

- 10 COVER ASYMMETRIC**
- P33-BAS-9006
 - P33-BAS-9016
 - P33-BAS-9005

- 11 RECESSED-MOUNT BRACKET FRAME**
- P33-MOB-E-1
- 1x per max. 900mm
min. 2 pcs.
- 12,5-40mm

- 14 FEED-TROUGH WIRING FOR BLANK COVER**
- P33-DV-BLI
- Sold by the metre
Meterware
Marchandise vendue au mètre

- 15 BRIDGING FOR LIGHT SOURCES**
- P33-DV-R
- max. 2250mm

- 17 3-PHASE TRACK**
- | | |
|----------------|--------|
| P33-3PH-110-AL | 1100mm |
| P33-3PH-110-WS | 1100mm |
| P33-3PH-110-SW | 1100mm |
| P33-3PH-210-AL | 2100mm |
| P33-3PH-210-WS | 2100mm |
| P33-3PH-210-SW | 2100mm |
- Power supply and end cap included
Inkl. Einspeisung u. Endabdeckung
Alimentation et embout inclus

- 18 MITRE CUT**
- | | | |
|------------|-------------|------|
| horizontal | P33-HOR-90 | 90° |
| | P33-HOR-135 | 135° |
| vertical | P33-VER-90 | 90° |
- Connectors included
Inklusive Verbinder
Connecteurs inclus

- 20 T-CONNECTOR**
- | | | |
|---------|-----|--------------------|
| P33-TV1 | 90° | pendant/surface |
| P33-TVE | 90° | recessed FRAME |
| P33-TVF | 90° | recessed FRAMELESS |

- 21 WALL BRACKET**
- P33-WAH-W
- 1x per max. 900mm
min. 2 pcs.

- 12 RECESSED-MOUNT BRACKET VARIO**
- P33-MOB-F-1
- 1x per max. 900mm
min. 2 pcs.
- 12,5-40mm

- 16 SEGMENT CONNECTOR**
- P33-LIN
- In pairs; Hexagon socket screws included
Paarweise; Inklusive Inbuschrauben
Paire; Vis à six pans creux incluses

- 19 CROSS CONNECTOR**
- | | | |
|---------|-----|--------------------|
| P33-KV1 | 90° | pendant/surface |
| P33-KVE | 90° | recessed FRAME |
| P33-KVF | 90° | recessed FRAMELESS |

- 22 CONNECTION TERMINAL**
- | | |
|----------|--------|
| P33-ANS5 | 5-pole |
| P33-ANS7 | 7-pole |
- Accessories incl; one terminal per power supply; clamping range 0.75 - 2.5 mm²
Inkl. Zubehör; eine Klemme pro Einspeisung; Klemmbereich 0,75 - 2,5 mm²
Accessoires inclus; un bornier par alimentation; plage de serrage 0,75 - 2,5 mm²

- 23 CONNECTION SET**
- | | |
|----------|--------|
| P33-DVS1 | 7-pole |
|----------|--------|

- 26 POWER FEED 3-PHASE-TRACK**
- | | |
|----------------|--------------|
| P33-EIN-3PH-WS | 3 x 1,50 mm² |
| P33-EIN-3PH-SW | 3 x 1,50 mm² |
- 2500 mm
3 phase universal adapter incl.
Inkl. 3-Phasen-Universaladapter
adaptateur universel 3 phases inclus

- 27B RAPID TENSIONER FOR INCLINED CEILINGS**
- | | |
|-------------|--------|
| P58-SEI-150 | 1500mm |
| P58-SEI-600 | 6000mm |

- 29 CONNECTOR**
- | | |
|----------|--------|
| P33-DVS2 | 7-pole |
|----------|--------|

- 24 POWER SUPPLY WITH CANOPY**
- | | |
|----------------|--------------|
| P33-EIN-3 | 3 x 0,75 mm² |
| P33-EIN-5 | 5 x 0,75 mm² |
| P33-EIN-7 | 7 x 0,75 mm² |
| P33-EIN-7-Q1,5 | 7 x 1,50 mm² |
- 1750 mm

- 27 SUSPENSION CABLES**
- 27A 27B
- 1x per max. 2000mm
min. 2 pcs.

- 27C CADDYCLIPS (T24)**
- | | |
|----------------|--------|
| P33-SEI-150-CC | 1500mm |
|----------------|--------|

- 30 LIGHT SOURCES**
- | |
|-----|
| 381 |
|-----|

- 25 POWER SUPPLY WITH DESIGN CANOPY**
- | | |
|--------------|--------------|
| P33-EIN-5-DB | 5 x 0,75 mm² |
|--------------|--------------|
- 1750 mm

- 27A RAPID TENSIONER**
- | | |
|-------------|--------|
| P33-SEI-150 | 1500mm |
| P33-SEI-600 | 6000mm |

- 28 BALL-PROOF BRACKET**
- | |
|----------------|
| P33-PBB-9006-2 |
| P33-PBB-9016-2 |
| P33-PBB-9006-2 |

- 31 P.FUSION**
- | |
|-----|
| 376 |
|-----|

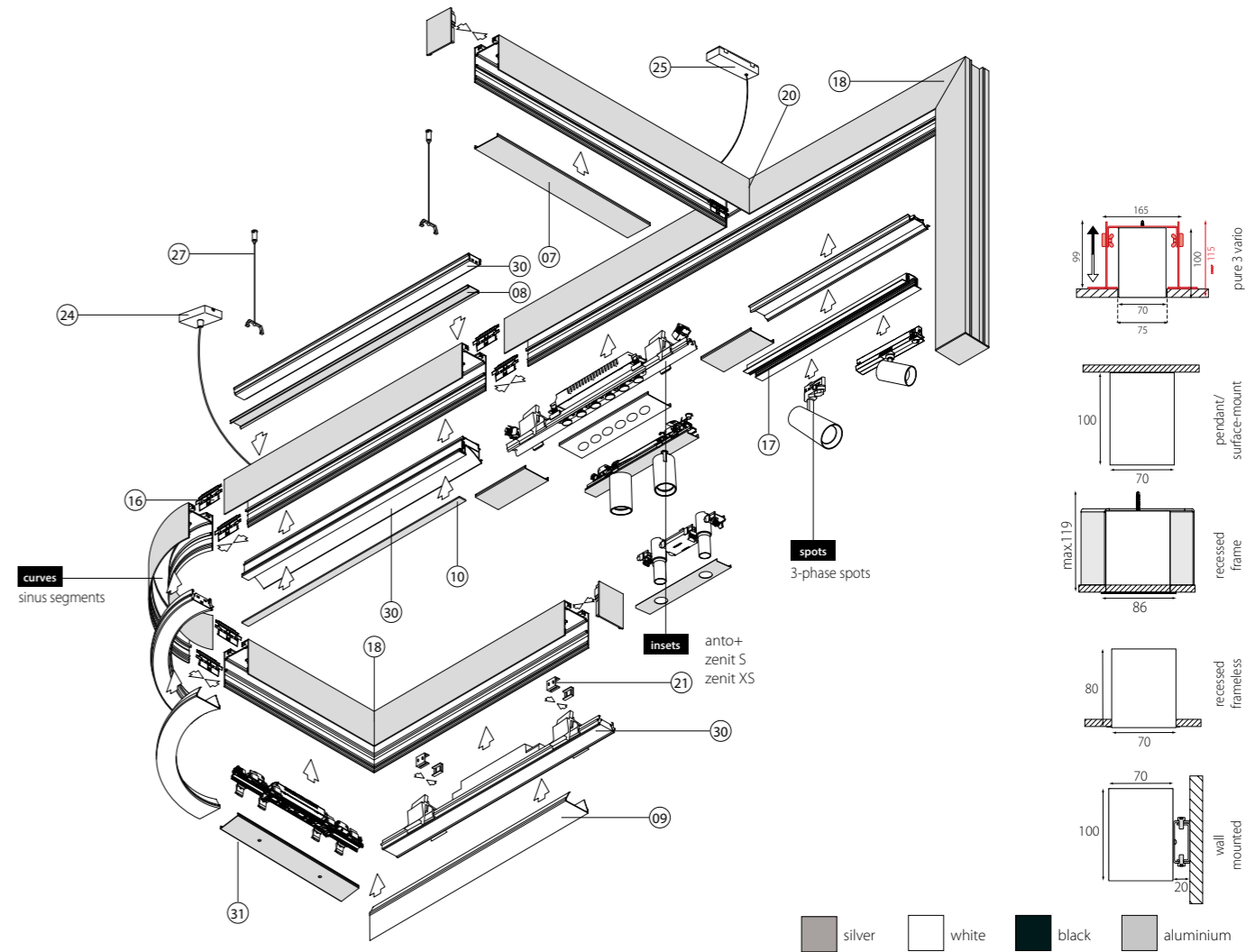

- silver
- white
- black
- aluminium

zenit XS inset for pure 3 systems

Systeme | Spotlight Inset pure 3
Systems | Spotlight Inset pure 3
Systèmes | Spotlight Inset pure 3

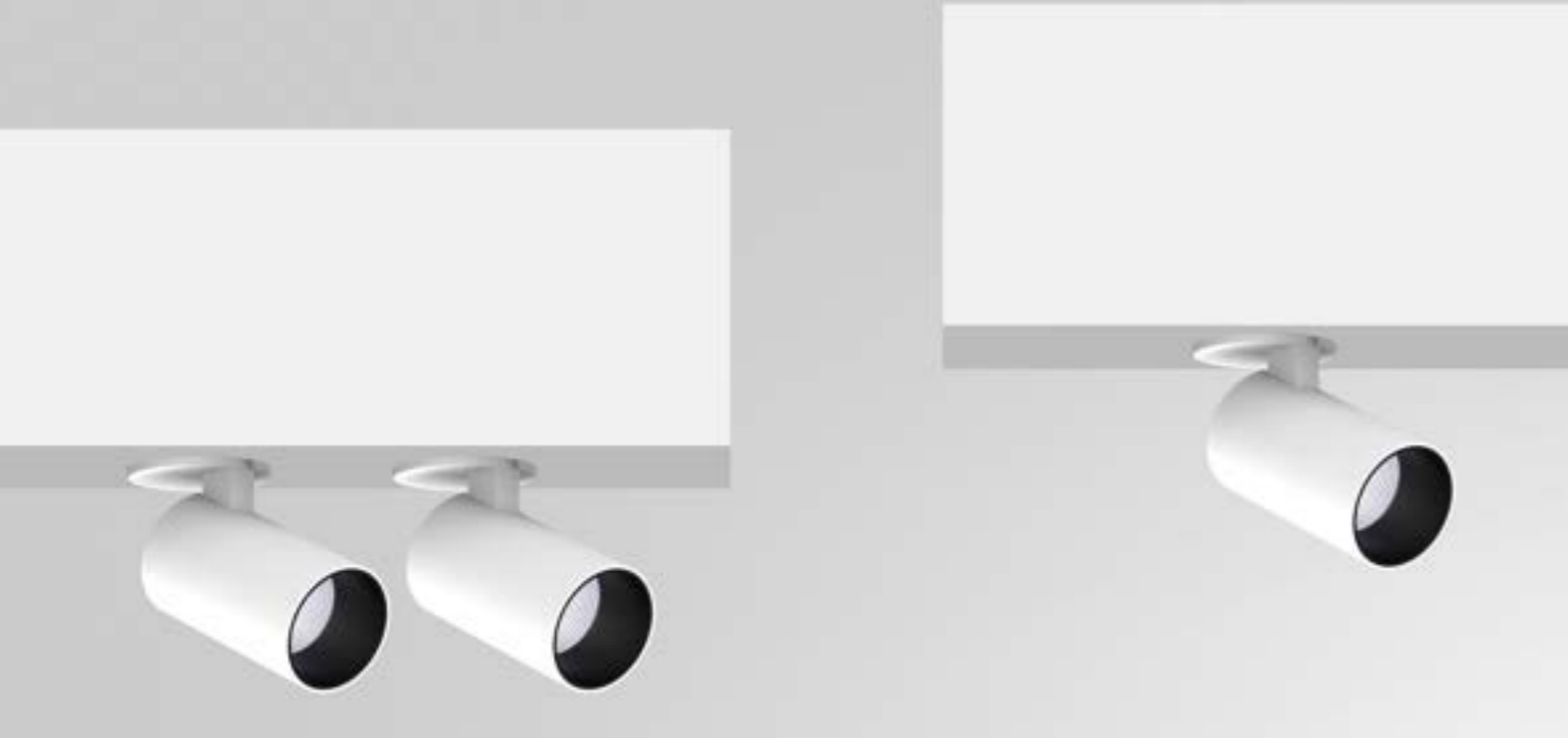

1 SPOTS

1 spot	1
2 spots	2

4 BLANK COVER

silver	SI
white	WS
black	SW

7 BEAM

24°	1
40°	4

2 TUBE COLOUR

gold	G
black	S

5 LED

LF830 3000 K	830
LF840 4000 K	840
LF927 2700 K	927
LF930 3000 K	930
LF940 4000 K	940

3 HOUSING COLOUR

white	W
black	S

6 CONTROL

non-dim	1
DALI	3

P33-Z 1 XS-2 3 4 5 H 6 7

P33-Z2XS-SWWS930H14 2 spots white, tube colour black, white housing, white blank cover, CRI > 90, 3000 K, non-dim, 40°, blind cover pure 3 in white (order sample)

► [Configure online on KATALOG.PLANLICHT.COM](https://www.planlicht.com)

ZENIT XS INSET FOR PURE 3 SYSTEMS | SYSTEMS

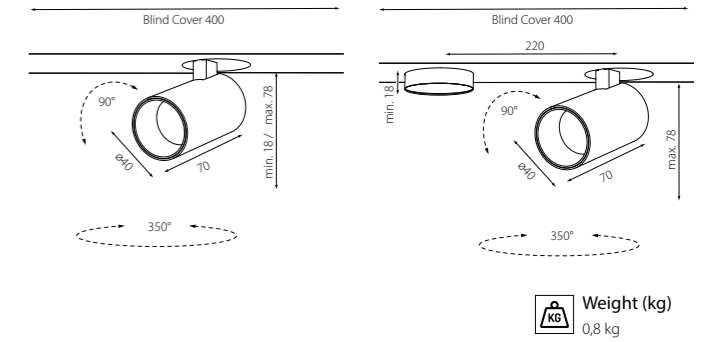
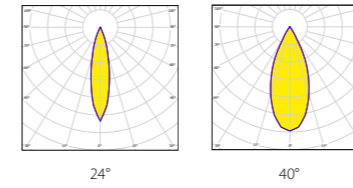

LUMINOUS FLUX (LM) / SYSTEM POWER (W)*

	24° (7,7W)		40° (7,7W)	
	gold	black	gold	black
LF830 3000 K	507 lm	453 lm	496 lm	443 lm
LF840 4000 K	529 lm	473 lm	518 lm	463 lm
LF927 2700 K	380 lm	340 lm	373 lm	333 lm
LF930 3000 K	404 lm	361 lm	395 lm	353 lm
LF940 4000 K	433 lm	387 lm	423 lm	378 lm

* figures per single spot

OPTIONAL ACCESSORY

Honeycomb glare protection	S10-BLE-40
Oval spot lens	S10-OZL-40
Blur glass	S10-WGL-40



Reflektortausch werkzeuglos möglich.
Passive Kühlung. Komplettrahler inklusive Reflektor und Konverter.
Replacement of the reflector without any tools.
Passive cooling. Complete spotlight including reflector and converter.
Remplacement du réflecteur sans outil.
Refroidissement passif. Projecteur complet incluant réflecteur et convertisseur.

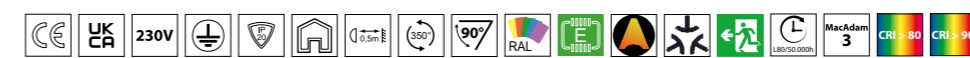

Down to UGR ≤ 16 | up to 66 lm/W | IEC 62471: Blue light hazard: RG ≤ 1 | DALI switchDIM

triflect inset

for pure 3 systems

Systeme | Downlight Inset pure 3
 Systems | Downlight Inset pure 3
 Systèmes | Downlight Inset pure 3

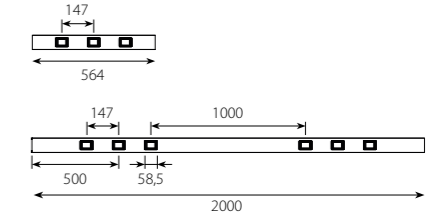
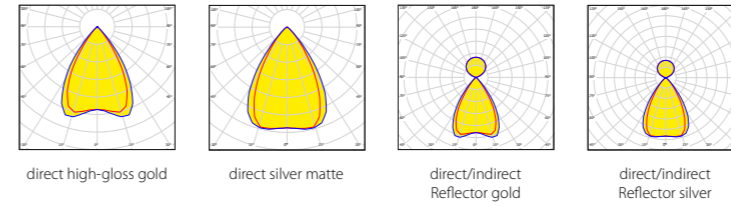

LUMINOUS FLUX (LM) / SYSTEM POWER (W), CRI > 80

4000 K silver matte	direct		KG	direct / indirect		KG
	low output	high output		low output	high output	
564 mm	1851 lm / 17,5W	3018 lm / 32W	0,9 kg	2879 lm / 23W	4806 lm / 43W	1,1 kg
2000 mm	3702 lm / 35W	6036 lm / 65W	2,4 kg	7331 lm / 54W	12010 lm / 100W	3,0 kg

COMPARE REFLECTOR COLOUR, 2000 MM, 4000 K, CRI > 80

silver matte	3702 lm	6036 lm	7331 lm	12010 lm
high-gloss gold	3060 lm	5112 lm	6689 lm	11086 lm

1 SPOTS

3 spot
6 spots

03
06

2 BLANK COVER



SI
WS
SW

3 DIRECT / INDIRECT

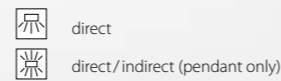

1
2

4 OUTPUT / CONTROL

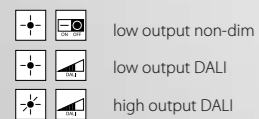

L1
L3
H3

5 TUBE COLOUR

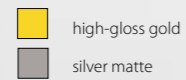

G
P

P3T-1-2-3-840-4-5

P3T-03-WS1840L1G triflect inset pure 3, 3 spots, blank cover white, direct, 4000 K, CRI > 80, low output, non-dim, gold (order sample)

► Configure online on KATALOG.PLANLICHT.COM



Down to UGR ≤ 19 | up to 136 lm/W | IEC 62471: Blue light hazard: RG 0 | DALI switchDIM

sinus segments

(compatible with pure 3 systems)

Systeme | Komponenten
Systems | Components
Systèmes | Composants

SINUS | SYSTEMS

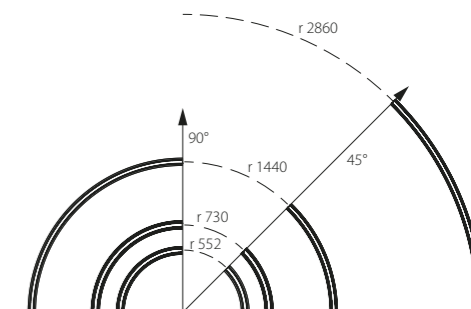
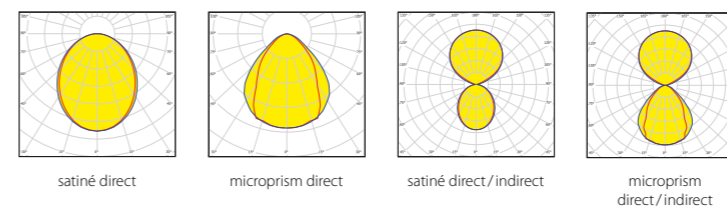

1 MOUNTING

- surface-mount/pendant direct
- pendant direct-indirect
- recessed

2 ANGLE / RADIUS

Code	Angle / Radius	Weight
A	45°, r 552 mm	14
H	90°, r 552 mm	19
E	45°, r 730 mm	34
	90°, r 730 mm	39
	45°, r 1440 mm	54
	90°, r 1440 mm	59
	45°, r 2860 mm	74

3 COLOUR

- silver **9006**
- white **9016**
- black **9005**
- RAL of your choice **9005**

4 DIRECT / INDIRECT

- direct **1**
- direct / indirect (pendant only) **2**

5 LED

- 3000 K, CRI > 80 **830**
- 4000 K, CRI > 80 **840**
- 3000 K, CRI > 90 **930**
- 4000 K, CRI > 90 **940**
- 2700 - 6500 K, dynamic white, CRI > 90 **HCL**

6 OUTPUT / CONTROL

- low output non-dim **L1**
- low output DALI **L3**
- high output DALI **H3**
- dynamic white **X3**

7 OPTIC

- satiné **S**
- microprism* **M**

* UGR-optimised, configure online

P33-1-2-3-E-4-5-6

P33-H14-9016E2830H3S pendant, segment angle 45°, r 552 mm, white, IP 40, direct / indirect, 3000 K, CRI > 80, high output DALI, satiné (order sample)

► Configure online on KATALOG.PLANLICHT.COM

LUMINOUS FLUX (LM) / SYSTEM POWER (W), CRI > 80

satiné (S)	direct				dynamic white CRI > 90 2700-6500 K	direct / indirect				dynamic white CRI > 90 2700-6500 K
	low output		high output			low output		high output		
	3000 K	4000 K	3000 K	4000 K		3000 K	4000 K	3000 K	4000 K	
45°, r 552 mm	591 lm / 6,4 W	613 lm / 6,4 W	1056 lm / 11 W	1095 lm / 11 W	-	1291 lm / 12 W	1339 lm / 12 W	2308 lm / 21 W	2393 lm / 21 W	-
90°, r 552 mm	1182 lm / 13,5 W	1225 lm / 13,5 W	2112 lm / 22 W	2190 lm / 22 W	1658 lm / 22 W	2583 lm / 23 W	2678 lm / 23 W	4616 lm / 43 W	4787 lm / 43 W	3624 lm / 41 W
45°, r 730 mm	788 lm / 9,1 W	817 lm / 9,1 W	1408 lm / 15,5 W	1460 lm / 15,5 W	1105 lm / 16 W	1722 lm / 17 W	1785 lm / 17 W	3077 lm / 28 W	3191 lm / 28 W	2415 lm / 28 W
90°, r 730 mm	1576 lm / 17,5 W	1634 lm / 17,5 W	2816 lm / 29 W	2920 lm / 29 W	2210 lm / 29 W	3444 lm / 29 W	3571 lm / 29 W	6155 lm / 56 W	6382 lm / 56 W	4831 lm / 55 W
45°, r 1440 mm	1576 lm / 17,5 W	1634 lm / 17,5 W	2816 lm / 29 W	2920 lm / 29 W	2210 lm / 29 W	3444 lm / 29 W	3571 lm / 29 W	6155 lm / 56 W	6382 lm / 56 W	4831 lm / 55 W
90°, r 1440 mm	3152 lm / 29 W	3268 lm / 29 W	5633 lm / 56 W	5841 lm / 56 W	4422 lm / 55 W	6887 lm / 58 W	7141 lm / 58 W	12310 lm / 112 W	12765 lm / 112 W	9663 lm / 110 W
45°, r 2860 mm	3152 lm / 29 W	3268 lm / 29 W	5633 lm / 56 W	5841 lm / 56 W	4422 lm / 55 W	6887 lm / 58 W	7141 lm / 58 W	12310 lm / 112 W	12765 lm / 112 W	9663 lm / 110 W

LUMINOUS FLUX (LM) / SYSTEM POWER (W), CRI > 80

microprism (M)*	direct				dynamic white CRI > 90 2700-6500 K	direct / indirect				dynamic white CRI > 90 2700-6500 K
	low output		high output			low output		high output		
	3000 K	4000 K	3000 K	4000 K		3000 K	4000 K	3000 K	4000 K	
45°, r 552 mm	636 lm / 6,4 W	660 lm / 6,4 W	1136 lm / 11 W	1178 lm / 11 W	-	1336 lm / 12 W	1386 lm / 12 W	2388 lm / 21 W	2476 lm / 21 W	-
90°, r 552 mm	1272 lm / 13,5 W	1318 lm / 13,5 W	2272 lm / 22 W	2356 lm / 22 W	1784 lm / 22 W	2673 lm / 23 W	2771 lm / 23 W	4776 lm / 43 W	4953 lm / 43 W	3750 lm / 41 W
45°, r 730 mm	848 lm / 9,1 W	879 lm / 9,1 W	1515 lm / 15,5 W	1571 lm / 15,5 W	1189 lm / 16 W	1782 lm / 17 W	1847 lm / 17 W	3184 lm / 28 W	3302 lm / 28 W	2499 lm / 28 W
90°, r 730 mm	1696 lm / 17,5 W	1758 lm / 17,5 W	3030 lm / 29 W	3142 lm / 29 W	2378 lm / 29 W	3564 lm / 29 W	3695 lm / 29 W	6369 lm / 56 W	6604 lm / 56 W	4999 lm / 55 W
45°, r 1440 mm	1696 lm / 17,5 W	1758 lm / 17,5 W	3030 lm / 29 W	3142 lm / 29 W	2378 lm / 29 W	3564 lm / 29 W	3695 lm / 29 W	6369 lm / 56 W	6604 lm / 56 W	4999 lm / 55 W
90°, r 1440 mm	3391 lm / 29 W	3516 lm / 29 W	6060 lm / 56 W	6284 lm / 56 W	4757 lm / 55 W	7126 lm / 58 W	7389 lm / 58 W	12737 lm / 112 W	13208 lm / 112 W	9998 lm / 110 W
45°, r 2860 mm	3391 lm / 29 W	3516 lm / 29 W	6060 lm / 56 W	6284 lm / 56 W	4757 lm / 55 W	7126 lm / 58 W	7389 lm / 58 W	12737 lm / 112 W	13208 lm / 112 W	9998 lm / 110 W

WEIGHT

45°, r 552 mm	0,8 kg
90°, r 552 mm	1,6 kg
45°, r 730 mm	1,0 kg
90°, r 730 mm	2,1 kg
45°, r 1440 mm	2,0 kg
90°, r 1440 mm	4,0 kg
45°, r 2860 mm	4,0 kg

*Der angegebene Lichtstrom bezieht sich auf die Leuchte mit klarer mikroprismatischer Abdeckung. Die Leuchte wird mit satinierter Folie zur Erhöhung der Homogenität geliefert (Direkt strahlend: -28,2%, direkt/indirekt strahlend: -11,7% Lichtstrom).

The indicated luminous flux corresponds to the luminaire with a clear microprismatic diffuser. The luminaire is delivered with a satinized foil for increased homogeneity (direct: -28,2%, direct/indirect: -11,7% luminous flux).

Le flux lumineux indiqué correspond au luminaire avec diffuseur microprismatique transparent. Le luminaire est livré avec un film satiné pour optimiser l'homogénéité (direct: -28,2%, direct/indirect: -11,7% sur le flux lumineux).



Down to UGR ≤ 16 | up to 127 lm/W | IEC 62471: Blue light hazard: RG 0 | DALI switchDIM

STEH - LEUCHTE

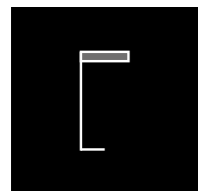

Floor lamp
Lampadaire



XERXES
394

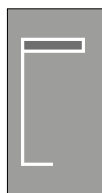

xerxes

Stehleuchte
Floor lamp
Lampadaire



1 COLOUR

- silver
- white
- black

2 LED

- SISI** 3000 K, CRI > 90
- WSWS** 4000 K, CRI > 90
- SWSW** 2700 - 6500 K, dynamic white, CRI > 90 (no sensor)

3 DIMMING & SENSORS

- dimmable, no sensor **X3**
- daylight and motion sensor **X7**

T59T061-1C2X3M

T59T061-WSWSC2940X7M white, 4000 K, CRI > 90, daylight and motion sensor, microprism (order sample)

► [Configure online on KATALOG.PLANLICHT.COM](#)

XERXES | FLOOR

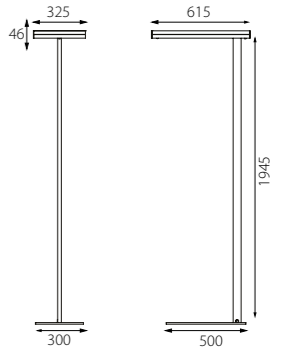
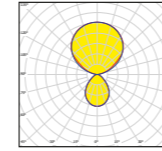

LUMINOUS FLUX (LM) / SYSTEM POWER (W)

3000 K	4000 K	dynamic white	13,7 kg
8230 lm / 78 W	8670 lm / 78 W	7267 lm / 77 W	



UGR ≤ 16 | up to 111 lm/m | IEC 62471: Blue light hazard: RG ≤ 1

3-PHASEN-LEUCHTEN

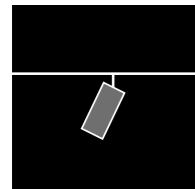

3-Phase track lights
Luminaires pour rail 3 phases

3-PHASEN-STRAHLER | 3-PHASE SPOTLIGHT | PROJECTEUR À 3 PHASES



ZENIT
398

METEOR
404

3-PHASEN-LEUCHTEN | 3-PHASE LUMINAIRES | LUMINAIRES À 3 PHASES

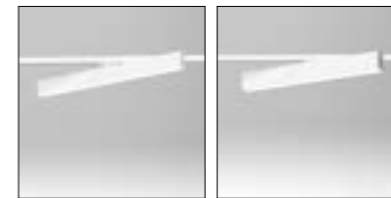

PFORTY
406

PURE 3
408

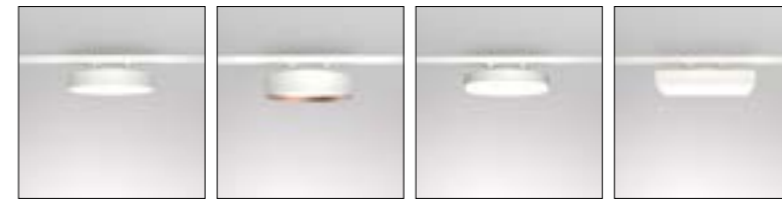

OPHELIA
410

ODELIA
412

LILIBET
414

OLMO
416

KOMPONENTEN | COMPONENTS | COMPOSANTS

418

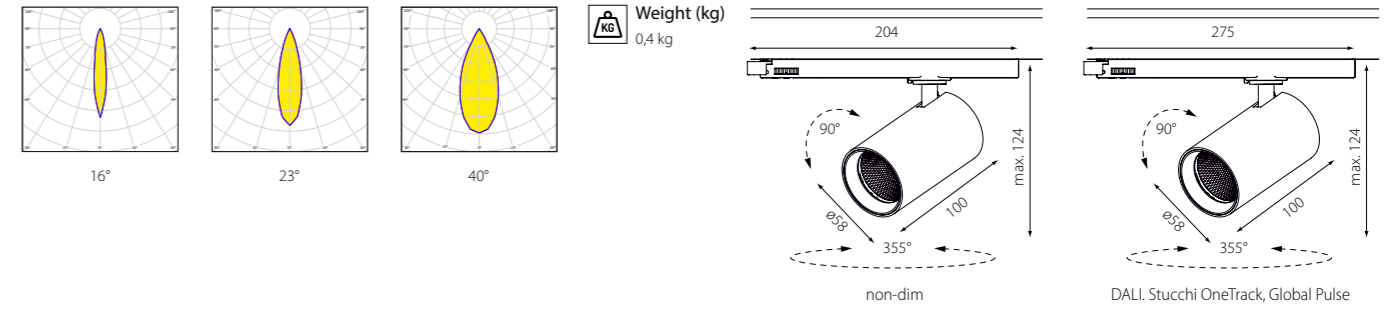

Reflektortausch werkzeuglos möglich.
Passive Kühlung. Komplettrahler inklusive Reflektor und Konverter.
Replacement of the reflector without any tools.
Passive cooling. Complete spotlight including reflector and converter.
Remplacement du réflecteur sans outil.
Refroidissement passif. Projecteur complet incluant réflecteur et convertisseur.

LUMINOUS FLUX (LM) / SYSTEM POWER (W)

	low output (7,3W)						high output (11W)					
	16°		23°		40°		16°		23°		40°	
	gold	black	gold	black	gold	black	gold	black	gold	black	gold	black
LF830 3000K	820lm	796lm	784lm	761lm	768lm	746lm	1161lm	1127lm	1112lm	1079lm	1088lm	1056lm
LF840 4000K	859lm	834lm	825lm	801lm	803lm	779lm	1217lm	1181lm	1172lm	1138lm	1139lm	1106lm
LF927 2700K	644lm	625lm	623lm	605lm	609lm	591lm	913lm	887lm	881lm	855lm	862lm	837lm
LF930 3000K	672lm	653lm	646lm	627lm	631lm	613lm	933lm	906lm	903lm	877lm	878lm	852lm
LF935 3500K	704lm	683lm	679lm	659lm	660lm	641lm	987lm	958lm	952lm	924lm	925lm	898lm
LF940 4000K	713lm	692lm	686lm	666lm	667lm	647lm	988lm	960lm	943lm	916lm	921lm	895lm

OPTIONAL ACCESSORY

Blendschutz-Wabenraster Honeycomb glare protection Filtre anti-éblouissement nid d'abeilles	S10-BLE-58
Ovalzeichnerlinse Refractor for elliptical distribution Lentille ovalisante	S10-OZL-58
Klares Schutzglas Clear protective glass Verre de protection transparent	S10-SGL-58
Weichzeichnerglas Diffuser protection glass Verre effet flou	S10-WGL-58

1 TUBE COLOUR

- gold
- black

2 HOUSING COLOUR

- GD white
- SW black

3 LED

- WS 3000 K, CRI > 80 **830**
- SW 4000 K, CRI > 80 **840**
- 2700 K, CRI > 90 **927**
- 3000 K, CRI > 90 **930**
- 3500 K, CRI > 90 **935**
- 4000 K, CRI > 90 **940**

4 OUTPUT

- L low output (non-dim only)
- H high output

5 CONTROL

- 1 non-dim
- G DALI Stucchi OneTrack/Global Pulse

6 BEAM

- 1 16°
- 2 23°
- 4 40°

S10S100-1-2-C1-3-4-5-6

S10S100-GDWSC1940H12 tube colour gold, housing white, IP 20, CRI > 90, 4000K, high output, non-dim, 23° (order sample)

► Configure online on KATALOG.PLANLICHT.COM



up to 118lm/W | IEC 62471: Blue light hazard: RG ≤ 1 | DALI

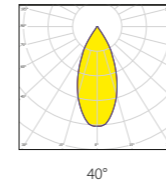

Weight (kg)
0,5 kg

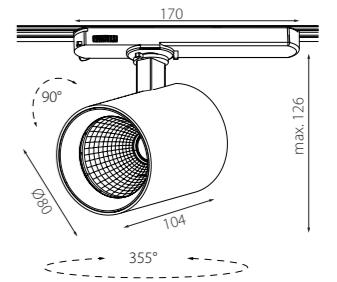

Reflektortausch werkzeuglos möglich.
Passive Kühlung. Komplettrahler inklusive Reflektor und Konverter.
Replacement of the reflector without any tools.
Passive cooling. Complete spotlight including reflector and converter.
Remplacement du réflecteur sans outil.
Refroidissement passif. Projecteur complet incluant réflecteur et convertisseur.



LUMINOUS FLUX (LM) / SYSTEM POWER (W)

	high output (27W)
	40°
LF930 3000 K	2680 lm
LF940 4000 K	2821 lm

OPTIONAL ACCESSORY

Blendschutz-Wabenraster Honeycomb glare protection Filtre anti-éblouissement nid d'abeilles	S10-BLE-80
Ovalzeichnerlinse Refractor for elliptical distribution Lentille ovalisante	S10-OZL-80
Klares Schutzglas Clear protective glass Verre de protection transparent	S10-SGL-80
Weichzeichnerglass Diffuser protection glass Verre effet flou	S10-WGL-80

1 HOUSING COLOUR

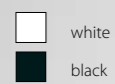

white
black

WS
SW

2 LED

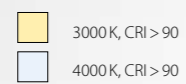

3000 K, CRI > 90
4000 K, CRI > 90

930
940

S10S104-SW 1 C1 2 H14

S10S104-SWWSC1940H14 tube colour black, housing white, IP 20, CRI > 90, 4000K, high output, non-dim, beam angle 40° (order sample)

► [Configure online on KATALOG.PLANLICHT.COM](#)

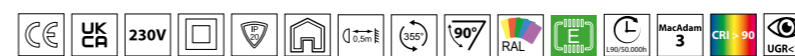

up to 104lm/W | IEC 62471: Blue light hazard: RG ≤ 1

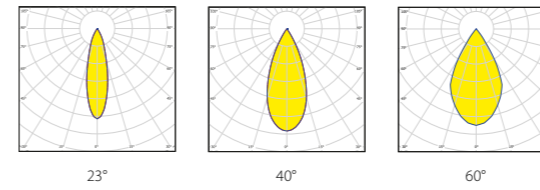

Weight (kg)
1,4 kg

Reflektortausch werkzeuglos möglich.
Passive Kühlung. Komplettrahler inklusive Reflektor und Konverter.
Replacement of the reflector without any tools.
Passive cooling. Complete spotlight including reflector and converter.
Remplacement du réflecteur sans outil.
Refroidissement passif. Projecteur complet incluant réflecteur et convertisseur.

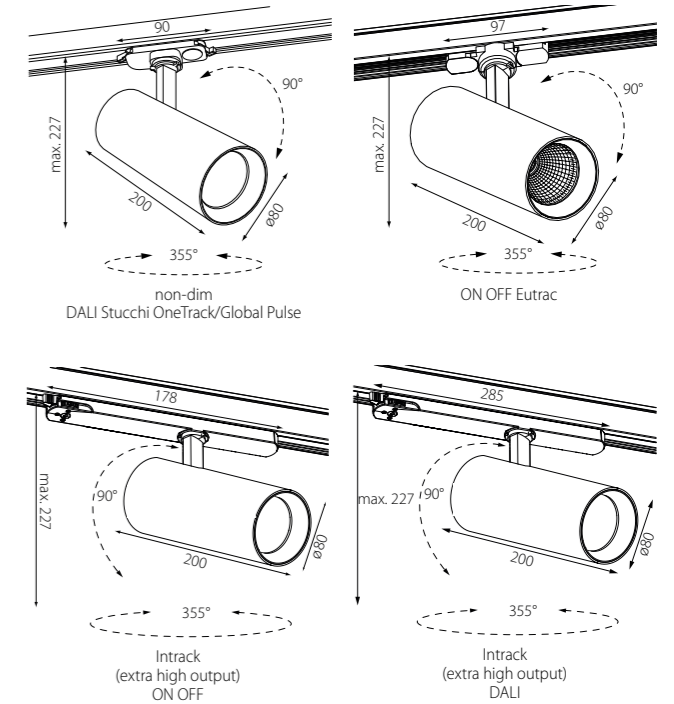

LUMINOUS FLUX (LM) / SYSTEM POWER (W)

	low output (9,3 - 10W)			medium output (11 - 12W)			high output (17 - 18,5W)			very high output (22 - 24W)			extra high output (41 - 44W)		
	23°	40°	60°	23°	40°	60°	23°	40°	60°	23°	40°	60°	23°	40°	60°
LF830 3000K	1112lm	1107lm	1088lm	1322lm	1316lm	1293lm	1931lm	1917lm	1884lm	2505lm	2482lm	2440lm	4340lm	4300lm	4090lm
LF840 4000K	1180lm	1164lm	1144lm	1404lm	1384lm	1360lm	2050lm	2023lm	1988lm	2658lm	2624lm	2579lm	4605lm	4546lm	4324lm
LF927 2700K	901lm	899lm	884lm	1072lm	1069lm	1051lm	1565lm	1565lm	1538lm	2029lm	2018lm	1983lm	3515lm	3496lm	3325lm
LF930 3000K	944lm	952lm	936lm	1122lm	1130lm	1111lm	1629lm	1643lm	1615lm	2102lm	2120lm	2084lm	3247lm	3275lm	3219lm
LF935 3500K	967lm	974lm	957lm	1151lm	1159lm	1139lm	1687lm	1696lm	1667lm	2196lm	2203lm	2165lm	3393lm	3403lm	3345lm
LF940 4000K	976lm	989lm	972lm	1161lm	1175lm	1155lm	1696lm	1713lm	1684lm	2199lm	2219lm	2181lm	3397lm	3428lm	3369lm
FAS	880lm	880lm	837lm	1047lm	1046lm	995lm	1531lm	1523lm	1449lm	1988lm	1969lm	1873lm	3444lm	3411lm	3244lm
BAC	604lm	598lm	569lm	716lm	710lm	675lm	1038lm	1034lm	984lm	1333lm	1336lm	1271lm	2309lm	2315lm	2202lm
FLE	604lm	598lm	569lm	717lm	710lm	675lm	1039lm	1031lm	981lm	1334lm	1328lm	1263lm	2311lm	2301lm	2189lm
WUR	570lm	568lm	540lm	679lm	676lm	643lm	994lm	990lm	942lm	1293lm	1287lm	1224lm	2240lm	2230lm	2121lm
FIS	924lm	924lm	879lm	1100lm	1098lm	1044lm	1608lm	1599lm	1521lm	2088lm	2067lm	1966lm	3618lm	3581lm	3406lm
FRU	774lm	769lm	731lm	930lm	924lm	879lm	1403lm	1396lm	1328lm	1879lm	1875lm	1783lm	3255lm	3249lm	3090lm

OPTIONAL ACCESSORY

Blendschutz-Wabenraster Honeycomb glare protection Filtre anti-éblouissement nid d'abeilles	S10-BLE-80
Ovalzeichnerlinse Refractor for elliptical distribution Lentille ovalisante	S10-OZL-80
Klares Schutzglas Clear protective glass Verre de protection transparent	S10-SGL-80
Weichzeichnerglas Diffuser protection glass Verre effet flou	S10-WGL-80

1 TUBE COLOUR

- black matte (RAL 9005)
- high-gloss silver
- silver matte
- high gloss black chrome
- high-gloss copper
- capital copper
- high-gloss gold
- glaring gold
- gunnery grey

- SW
- BB
- PP
- ZZ
- KK
- RR
- GG
- DD
- YY

2 HOUSING COLOUR

- white
- black

3 LED

- 3000 K, CRI > 80 **830**
- 4000 K, CRI > 80 **840**
- 2700 K, CRI > 90 **927**
- 3000 K, CRI > 90 **930**
- 3500 K, CRI > 90 **935**
- 4000 K, CRI > 90 **940**
- Fashion (3250 K) **FAS**
- Bakery goods **BAC**
- Meat **FLE**
- Sausage products **WUR**
- Fish **FIS**
- Fruits & Vegetables **FRU**

4 OUTPUT

- low output
- medium output
- high output
- very high output
- extra high output (not DALI Eutrac)

5 CONTROL

- L non-dim
- M DALI Eutrac
- H DALI, Stucchi OneTrack/Global Pulse
- V
- E

6 BEAM

- 1 23° **2**
- 3 40° **4**
- 6 60° **6**

S10S200-1-2-C1-3-4-5-6

S10S200-GGWSC1FLEM34 tube colour high-gloss gold, housing white, special LED meat, medium output, DALI Eutrac, 40° (order sample)

► Configure online on KATALOG.PLANLICHT.COM



Down to UGR ≤ 16 | up to 118lm/W | IEC 62471: Blue light hazard: RG ≤ 1 | DALI

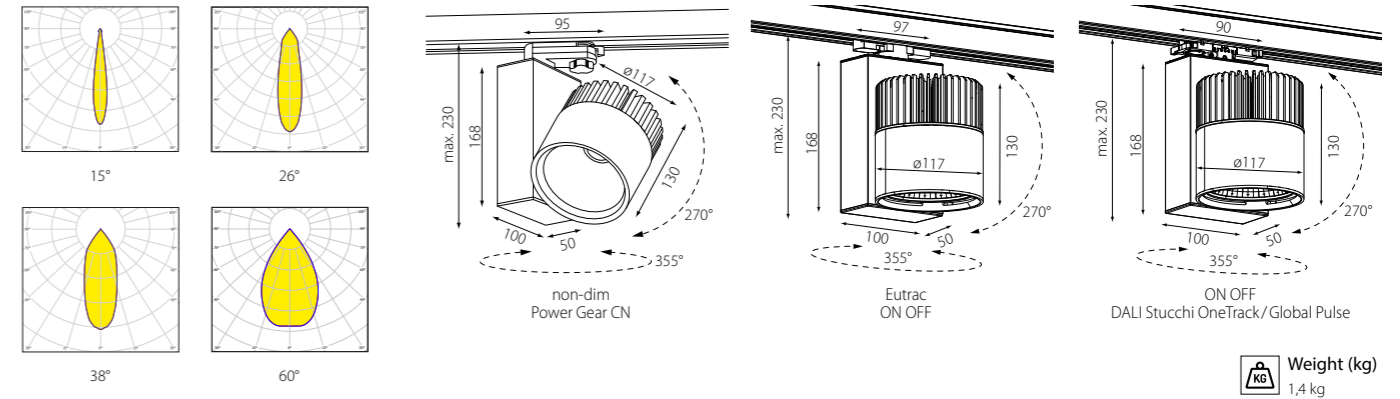

Weight (kg)
1,4 kg

Reflektortausch werkzeuglos möglich.
Passive Kühlung, Komplettrahler inklusive Reflektor und Konverter.
Replacement of the reflector without any tools.
Passive cooling. Complete spotlight including reflector and converter.
Remplacement du réflecteur sans outil.
Refroidissement passif. Projecteur complet incluant réflecteur et convertisseur.

LUMINOUS FLUX (LM) / SYSTEM POWER (W)

	low output (19,5 - 20 W)				medium output (25 - 26 W)				high output (31 - 32 W)				very high output (40 - 41 W)			
	15°	26°	38°	60°	15°	26°	38°	60°	15°	26°	38°	60°	15°	26°	38°	60°
LF830 3000 K	2587 lm	2729 lm	2727 lm	2813 lm	3246 lm	3429 lm	3428 lm	3657 lm	3850 lm	4072 lm	4073 lm	4500 lm	4734 lm	5021 lm	5028 lm	5907 lm
LF840 4000 K	2726 lm	2880 lm	2874 lm	2841 lm	3426 lm	3626 lm	3618 lm	3693 lm	4072 lm	4318 lm	4305 lm	4546 lm	5028 lm	5349 lm	5330 lm	5966 lm
LF927 2700 K	2104 lm	2230 lm	2222 lm	2255 lm	2646 lm	2802 lm	2794 lm	2932 lm	3145 lm	3330 lm	3322 lm	3608 lm	3884 lm	4111 lm	4104 lm	4736 lm
LF930 3000 K	2220 lm	2392 lm	2387 lm	2762 lm	2799 lm	3008 lm	3003 lm	3590 lm	3335 lm	3577 lm	3572 lm	4419 lm	4140 lm	4421 lm	4416 lm	5800 lm
LF935 3500 K	2288 lm	2461 lm	2452 lm	2879 lm	2890 lm	3107 lm	3094 lm	3743 lm	3454 lm	3712 lm	3693 lm	4607 lm	4306 lm	4623 lm	4594 lm	6046 lm
LF940 4000 K	2311 lm	2487 lm	2482 lm	2746 lm	2908 lm	3125 lm	3122 lm	3244 lm	3459 lm	3712 lm	3711 lm	4190 lm	4277 lm	4737 lm	4747 lm	5276 lm
FAS	1932 lm	2031 lm	2027 lm	2958 lm	2473 lm	2596 lm	2593 lm	3846 lm	2996 lm	3140 lm	3138 lm	4733 lm	3989 lm	4167 lm	4170 lm	6213 lm
BAC	1306 lm	1377 lm	1376 lm	2094 lm	1664 lm	1748 lm	1748 lm	2722 lm	2008 lm	2100 lm	2102 lm	3350 lm	2647 lm	2745 lm	2752 lm	4397 lm
FLE	1310 lm	1379 lm	1378 lm	1385 lm	1671 lm	1754 lm	1753 lm	1800 lm	2017 lm	2110 lm	2108 lm	2216 lm	2665 lm	2769 lm	2766 lm	2908 lm
WUR	1263 lm	1327 lm	1323 lm	1392 lm	1614 lm	1691 lm	1687 lm	1810 lm	1953 lm	2037 lm	2034 lm	2227 lm	2589 lm	2683 lm	2683 lm	2923 lm
FIS	2048 lm	2153 lm	2149 lm	1349 lm	2621 lm	2753 lm	2748 lm	1754 lm	3176 lm	3328 lm	3326 lm	2159 lm	4228 lm	4416 lm	4419 lm	2833 lm
FRU	1935 lm	2031 lm	2019 lm	2219 lm	2439 lm	2548 lm	2534 lm	2885 lm	2908 lm	3023 lm	3006 lm	3551 lm	3739 lm	3845 lm	3823 lm	4661 lm

dynamic white (43W)				
	15°	26°	38°	60°
dynamic white	2431 lm	2600 lm	2576 lm	2487 lm

1 HOUSING COLOUR

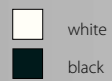

WSWS
SWSW

2 LED



830
840
927
930
935
940
FAS
BAC
FLE
WUR
FIS
FRU
HCL

3 OUTPUT



L
M
H
V
X

4 CONTROL

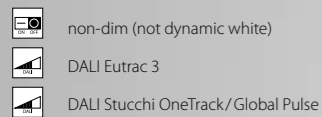

1
3
G

5 BEAM

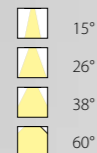

1
2
3
6 **NEW**

S03S172-1 C1 2 3 4 5

S03S172-SWSWC1935V32 Housing black, IP 20, CRI > 90, 3500K, very high output, DALI Eutrac, beam angle 26° (order sample)

► Configure online on KATALOG.PLANLICHT.COM

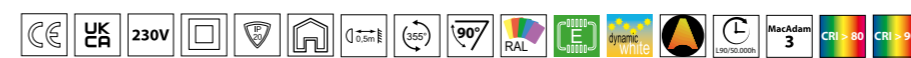

Down to UGR ≤ 19 | up to 138lm/W | IEC 62471: Blue light hazard: RG ≤ 1 | DALI

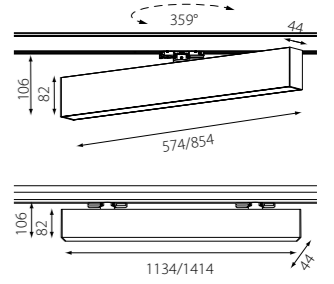
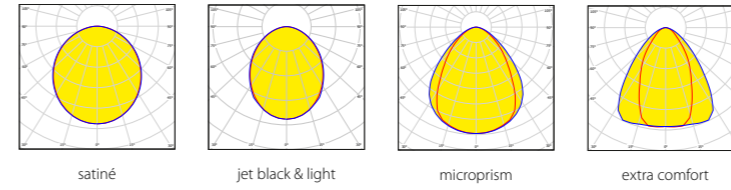

LUMINOUS FLUX (LM) / SYSTEM POWER (W)

4000K satiné	low output CRI > 80	high output CRI > 80	dynamic white CRI > 90	
574 mm	769lm / 7,5W	1339lm / 13,5W	1014lm / 14,5W	1,5 kg
854 mm	1185 lm / 11,5W	2073 lm / 19,5W	1569 lm / 19,5W	2,0 kg
1134 mm	1600lm / 15W	2804 lm / 24W	2123 lm / 25W	2,7 kg
1414 mm	2014lm / 17,5W	3532lm / 31W	2674 lm / 31W	3,2 kg

(based on DALI Eutrac)

COMPARE COVER 1414 MM, 4000 K

	low output CRI > 80	high output CRI > 80	dynamic white CRI > 90
satiné	2014lm	3532lm	2674lm
jet black & light	628lm	1101lm	834lm
microprism*	2047lm	3590lm	2718lm
extra comfort	2333lm	-	-

COMPARE LIGHT COLOUR 1414 MM SATINÉ

	low output CRI > 80	
4000 K, CRI > 80	2014lm	
4000 K, CRI > 90	1976lm	-1,9%
3000 K, CRI > 80	1922lm	
3000 K, CRI > 90	1862lm	-3,1%

*Der angegebene Lichtstrom bezieht sich auf die Leuchte mit klarer mikroprismatischer Abdeckung. Die Leuchte wird mit satiniertes Folie zur Erhöhung der Homogenität geliefert (-23% Lichtstrom).
The indicated luminous flux corresponds to the luminaire with a clear microprismatic diffuser. The luminaire is delivered with a satined-foil for increased homogeneity (-23% luminous flux).
Le flux lumineux indiqué correspond au luminaire avec diffuseur microprismatique transparent. Le luminaire est livré avec un film satiné pour optimiser l'homogénéité (-23% sur le flux lumineux).

<p>1 SIZE</p> <p>574 mm 057</p> <p>854 mm 085</p> <p>1134 mm 113</p> <p>1414 mm 141</p>	<p>2 HOUSING COLOUR</p> <p>057 silver</p> <p>085 white</p> <p>113 black</p> <p>141 RAL of your choice</p>	<p>3 LED</p> <p>9006 3000 K, CRI > 80 830</p> <p>9016 4000 K, CRI > 80 840</p> <p>9005 3000 K, CRI > 90 930</p> <p>940 4000 K, CRI > 90 940</p> <p>HCL 2700 - 6500 K dynamic white, CRI > 90</p>
<p>4 OUTPUT</p> <p>L low output</p> <p>H high output</p> <p>X dynamic white</p>	<p>5 CONTROL</p> <p>1 non-dim (not dynamic white)</p> <p>3 DALI Eutrac 3</p> <p>G DALI Stucchi OneTrack/Global Pulse</p>	<p>6 OPTIC</p> <p>S satiné</p> <p>J NEW jet black & light</p> <p>M microprism*</p> <p>E extra comfort UGR < 19* (low output only) *UGR-optimised, configure online</p>

P40S 1-2 C1 3 4 5 6

P40S085-9005C1830HGS track 854 mm, housing black, IP20, 3000 K, CRI > 80, high output, DALI Stucchi OneTrack/Global Pulse, satiné (order sample)

► [Configure online on KATALOG.PLANLICHT.COM](#)



up to 133 lm/W | IEC 62471: Blue light hazard: RG 0 | DALI

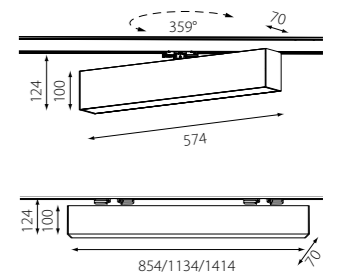
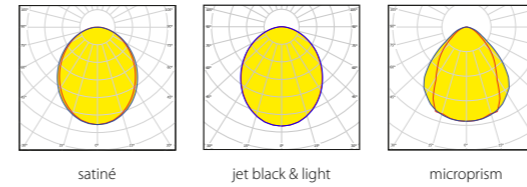

LUMINOUS FLUX (LM) / SYSTEM POWER (W)

4000K satiné	low output CRI > 80	high output CRI > 80	dynamic white CRI > 90	
574mm	735 lm / 8,2W	1328 lm / 15W	1005 lm / 16W	2,3 kg
854 mm	1126 lm / 12,5W	2033 lm / 21 W	1539 lm / 22W	3,2 kg
1134 mm	1514 lm / 16,5W	2734 lm / 28W	2070 lm / 28W	4,0 kg
1414 mm	1900 lm / 19,5W	3429 lm / 35W	2596 lm / 34W	4,9 kg

(based on DALI Eutrac)

COMPARE COVER 1414 MM, 4000 K

	low output CRI > 80	high output CRI > 80	dynamic white CRI > 90
satiné	1900 lm	3429 lm	2596 lm
jet black & light	478 lm	863 lm	653 lm
microprism*	2096 lm	3782 lm	2863 lm

COMPARE LIGHT COLOUR 1414 MM SATINÉ, LOW OUTPUT

4000 K, CRI > 80	1900 lm	-1,9%
4000 K, CRI > 90	1875 lm	
3000 K, CRI > 80	1832 lm	-3,1%
3000 K, CRI > 90	1775 lm	

*Der angegebene Lichtstrom bezieht sich auf die Leuchte mit klarer mikroprismatischer Abdeckung. Die Leuchte wird mit satiniertes Folie zur Erhöhung der Homogenität geliefert (-28,2% Lichtstrom).
The indicated luminous flux corresponds to the luminaire with a clear microprismatic diffuser. The luminaire is delivered with a satined-foil for increased homogeneity (-28,2% luminous flux).
Le flux lumineux indiqué correspond au luminaire avec diffuseur microprismatique transparent. Le luminaire est livré avec un film satiné pour optimiser l'homogénéité (-28,2 % sur le flux lumineux).

1 SIZE

574 mm
854 mm
1134 mm
1414 mm

2 HOUSING COLOUR

057 silver **9006**
085 white **9016**
113 black **9005**
141 RAL of your choice **H**

3 LED

3000 K, CRI > 80 **830**
 4000 K, CRI > 80 **840**
 3000 K, CRI > 90 **930**
 4000 K, CRI > 90 **940**
 2700 - 6500 K dynamic white, CRI > 90 **HCL**

4 OUTPUT

low output non-dim
 high output
 dynamic white

L
H
X

5 CONTROL

non-dim (not dynamic white) **1**
 DALI Eutrac 3 **3**
 DALI Stucchi OneTrack/Global Pulse **G**

6 OPTIC

satiné **S**
 jet black & light **J** **NEW**
 microprism* **M**

*UGR-optimised, configure online

P335 1-2 C1 3 4 5 6

P335141-9016C1840L15 track, 1414 mm, housing white, IP 20, 4000 K, CRI > 80, low output, non-dim, satiné (order sample)

► Configure online on [KATALOG.PLANLICHT.COM](https://www.katalog.planlicht.com)



up to 108 lm/W | IEC 62471: Blue light hazard: RG 0 | DALI

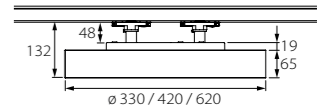
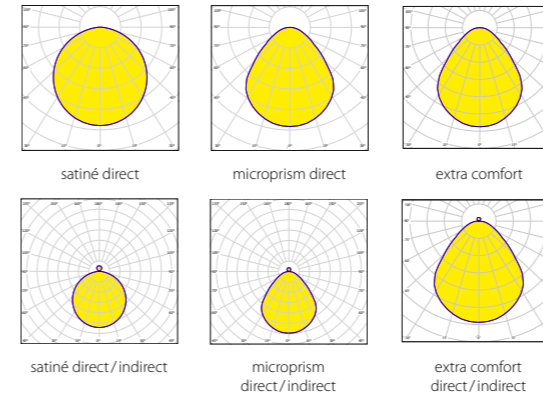

1 SIZE

ø 330 mm (direct only)	033
ø 420 mm	042
ø 620 mm	062

2 HOUSING COLOUR

black	9005
silver	9006
white	9016
RAL of your choice	☞

3 DIRECT / INDIRECT

	direct	1
	direct/indirect	2

4 LED

	3000 K, CRI > 80	830
	4000 K, CRI > 80	840
	3000 K, CRI > 90	930
	4000 K, CRI > 90	940
	2700 - 6500 K dynamic white, CRI > 90	HCL

5 OUTPUT

	low output	L
	high output	H
	very high output	V
	dynamic white	X

6 CONTROL

	non-dim (low output only)	1
	DALI Stucchi OneTrack/Global Pulse	G

7 OPTIC

	satiné	S
	microprism*	M
	extra comfort UGR < 19* (low output only)	E

*UGR-optimised, configure online

F53S **1-2F34567**

F53S042-9016F1840HGS track ø 420 mm, housing white, IP 50, 4000 K, CRI > 80, high output DALI Stucchi OneTrack/Global Pulse, satiné (order sample)

► [Configure online on KATALOG.PLANLICHT.COM](#)

LUMINOUS FLUX (LM) / SYSTEM POWER (W)

	low output CRI > 80		high output CRI > 80		very high output CRI > 80		dynamic white CRI > 90	
	direct	direct/indirect	direct	direct/indirect	direct	direct/indirect	direct	direct/indirect
4000K satiné								
ø 330 mm	962 lm / 7,4 W	-	2180 lm / 15 W	-	2661 lm / 18,5 W	-	1690 lm / 15 W	-
ø 420 mm	1651 lm / 11,5 W	1788 lm / 11,5 W	3218 lm / 22 W	3484 lm / 22 W	3993 lm / 28 W	4273 lm / 28 W	2494 lm / 22 W	2700 lm / 22 W
ø 620 mm	3513 lm / 22 W	3715 lm / 22 W	6346 lm / 40 W	6641 lm / 40 W	7938 lm / 51 W	8374 lm / 51 W	4695 lm / 39 W	4913 lm / 39 W

COMPARE COVER Ø 420 MM, 4000 K, CRI > 80, LOW OUTPUT

	low output CRI > 80		high output CRI > 80		very high output CRI > 80		dynamic white CRI > 90	
	direct	direct/indirect	direct	direct/indirect	direct	direct/indirect	direct	direct/indirect
satiné	1651 lm	1788 lm	3218 lm	3484 lm	3993 lm	4273 lm	2494 lm	2700 lm
microprism	1492 lm	1633 lm	2930 lm	3220 lm	3622 lm	3975 lm	2271 lm	2496 lm
extra comfort	1818 lm	1927 lm	3571 lm	3652 lm	4412 lm	4687 lm	2768 lm	2942 lm

WEIGHT

	direct	direct/indirect
ø 330 mm	2,3 kg	-
ø 420 mm	2,9 kg	3,0 kg
ø 620 mm	4,8 kg	5,2 kg

(based on optic S, DALI)

*Die angegebenen Lichtstromwerte (lm) beziehen sich auf Leuchten mit einem weißen Gehäuse (RAL 9016). Je nach Gehäusefarbe reduzieren sich diese entsprechend. All figures of luminous flux (lm) are for fixtures with white housing (RAL 9016). Depending on the housing colour, the luminous flux is reduced accordingly. Les valeurs de flux lumineux (lm) indiquées se réfèrent aux luminaires à corps blanc (RAL 9016). En fonction de la couleur du corps, celles-ci sont réduites en conséquence.



Down to UGR ≤ 19 | up to 169 lm/W | IEC 62471: Blue light hazard: RG 0 | DALI



1 SIZE

ø 330 mm (direct only)	033
ø 420 mm	042
ø 620 mm	062

2 HOUSING COLOUR

	silver - silver	SISI
	black - silver	SWSI
	capital copper - black	RRSW
	glaring gold - black	DDSW
	black - black	SWSW
	capital copper - white	RRWS
	glaring gold - white	DDWS
	black - white	SWWS
	white - white	WSWS
	RAL of your choice	

housing | Gehäuse | logement
decorative ring | Zier-Ring | anneau décoratif

3 DIRECT / INDIRECT

	direct	1
	direct / indirect	2

4 LED

	3000 K, CRI > 80	830
	4000 K, CRI > 80	840
	3000 K, CRI > 90	930
	4000 K, CRI > 90	940
	2700 - 6500 K dynamic white, CRI > 90	HCL

5 OUTPUT

	low output	L
	high output	H
	very high output	V
	dynamic white	X

6 CONTROL

	non-dim (low output only)	1
	DALI Stucchi OneTrack / Global Pulse	G

7 OPTIC

	satiné	S
	microprism*	M
	extra comfort UGR < 19* (low output only)	E

* UGR-optimised, configure online

F54S 1-2 F 3 4 5 6 7

F54S042-SISIF2830VGS track, ø 420 mm, silver decorative ring, silver housing, IP50, direct & indirect, 3000 K, CRI > 80, very high output, DALI Stucchi OneTrack / Global Pulse, satiné (order sample)

► [Configure online on KATALOG.PLANLICHT.COM](#)

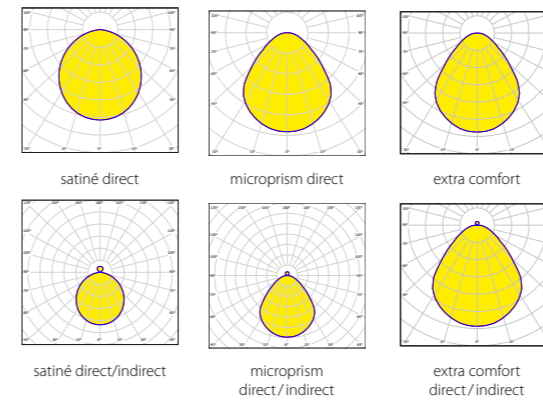

LUMINOUS FLUX (LM) / SYSTEM POWER (W)

4000 K satiné	direct				direct / indirect			
	low output CRI > 80	high output CRI > 80	very high output CRI > 80	dynamic white CRI > 90	low output CRI > 80	high output CRI > 80	very high output CRI > 80	dynamic white CRI > 90
ø 330 mm	885 lm / 7,4 W	2036 lm / 15 W	2524 lm / 18,5 W	1578 lm / 15 W	-	-	-	-
ø 420 mm	1550 lm / 11,5 W	3067 lm / 22 W	3865 lm / 28 W	2377 lm / 22 W	1687 lm / 11,5 W	3333 lm / 22 W	4145 lm / 28 W	2583 lm / 22 W
ø 620 mm	3385 lm / 22 W	6207 lm / 40 W	7884 lm / 51 W	4592 lm / 39 W	3587 lm / 22 W	6502 lm / 40 W	8320 lm / 51 W	4810 lm / 39 W

COMPARE COVER Ø 420 MM, 4000 K, CRI > 80

4000 K satiné	direct				direct / indirect			
	low output CRI > 80	high output CRI > 80	very high output CRI > 80	dynamic white CRI > 90	low output CRI > 80	high output CRI > 80	very high output CRI > 80	dynamic white CRI > 90
satiné	1550 lm	3067 lm	3865 lm	2377 lm	1687 lm	3333 lm	4145 lm	2583 lm
microprism	1401 lm	2793 lm	3506 lm	2164 lm	1542 lm	3083 lm	3859 lm	2389 lm
extra comfort	1708 lm	3405 lm	4274 lm	2638 lm	1817 lm	3629 lm	4627 lm	2812 lm

WEIGHT

	direct	direct / indirect
ø 330 mm	2,6 kg	-
ø 420 mm	3,3 kg	3,4 kg
ø 620 mm	5,4 kg	5,8 kg

(based on optic S, DALI)

*Die angegebenen Lichtstromwerte (lm) beziehen sich auf Leuchten mit einem weißen Gehäuse (RAL 9016). Je nach Gehäusefarbe reduzieren sich diese entsprechend.
All figures of luminous flux (lm) are for fixtures with white housing (RAL 9016). Depending on the housing colour, the luminous flux is reduced accordingly.
Les valeurs de flux lumineux (lm) indiquées se réfèrent aux luminaires à corps blanc (RAL 9016). En fonction de la couleur du corps, celles-ci sont réduites en conséquence.



Down to UGR ≤ 19 | up to 166 lm / W | IEC 62471: Blue light hazard: RG 0 | DALI

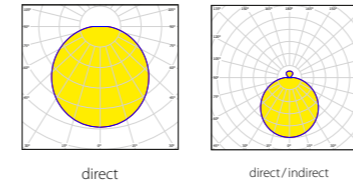

LUMINOUS FLUX (LM) / SYSTEM POWER (W)

4000K satiné	direct			direct/indirect			⚠️ kg
	low output CRI > 80	high output CRI > 80	dynamic white CRI > 90	low output CRI > 80	high output CRI > 80	dynamic white CRI > 90	
ø 330 mm	1269 lm / 10,5 W	2026 lm / 15 W	1570 lm / 15 W	-	-	-	2,5 kg
ø 420 mm	1787 lm / 12,5 W	3225 lm / 22 W	2025 lm / 18 W	1924 lm / 12,5 W	3491 lm / 22 W	2231 lm / 18 W	3,4 kg
ø 620 mm	3400 lm / 22 W	6142 lm / 40 W	4544 lm / 39 W	3602 lm / 22 W	6437 lm / 40 W	4762 lm / 39 W	6,4 kg

(based on optic S, DALI)

*Die angegebenen Lichtstromwerte (lm) beziehen sich auf Leuchten mit einem weißen Gehäuse (RAL 9016). Je nach Gehäusefarbe reduzieren sich diese entsprechend.
All figures of luminous flux (lm) are for fixtures with white housing (RAL 9016). Depending on the housing colour, the luminous flux is reduced accordingly.
Les valeurs de flux lumineux (lm) indiquées se réfèrent aux luminaires à corps blanc (RAL 9016). En fonction de la couleur du corps, celles-ci sont réduites en conséquence.

<p>1 SIZE</p> <ul style="list-style-type: none"> ø 330 mm (direct only) 033 ø 420 mm 042 ø 620 mm 062 	<p>2 HOUSING COLOUR</p> <ul style="list-style-type: none"> silver 9006 white 9016 black 9005 RAL of your choice 	<p>3 DIRECT / INDIRECT</p> <ul style="list-style-type: none"> direct 1 direct/indirect 2
<p>4 LED</p> <ul style="list-style-type: none"> 3000K, CRI > 80 830 4000K, CRI > 80 840 3000K, CRI > 90 930 4000K, CRI > 90 940 2700-6500K, dynamic white, CRI > 90 HCL 	<p>5 OUTPUT</p> <ul style="list-style-type: none"> low output L high output H dynamic white X 	<p>6 CONTROL</p> <ul style="list-style-type: none"> non-dim (only low output) 1 DALI Stucchi OneTrack/Global Pulse G

F52S 1-2C3456S

F52S042-9016C1840HGS track, ø 420 mm, housing white, IP 20, direct, 4000K, CRI > 80, high output, DALI Stucchi OneTrack/Global Pulse, satiné (order sample)

► [Configure online on KATALOG.PLANLICHT.COM](https://www.katalog.planlicht.com)

LATERAL DIFFUSER



up to 166 lm/W | IEC 62471: Blue light hazard: RG 0 | DALI



1 SIZE

330 x 330 mm (direct only)	03Q
456 x 456 mm	04Q
594 x 594 mm	05Q

2 COLOUR

	silver	9006
	white	9016
	black	9005
	RAL of your choice	

3 DIRECT / INDIRECT

	direct	1
	direct / indirect	2

4 LED

	3000 K, CRI > 80	830
	4000 K, CRI > 80	840
	3000 K, CRI > 90	930
	4000 K, CRI > 90	940
	2700 - 6500 K dynamic white, CRI > 90	HCL

5 OUTPUT

	low output non-dim	L
	high output DALI	H
	dynamic white	X

6 CONTROL

	non-dim (low output only)	1
	DALI Stucchi OneTrack / Global Pulse	G

7 OPTIC

	satiné	S
	microprism*	M
	extra comfort*	E

* UGR-optimised, configure online

F61S **1-2F234567**

F61S04Q-9016F2830HGS track, 456x456 mm, housing white, JP 50, direct / indirect, 3000 K, CRI > 80, high output DALI, Stucchi OneTrack / Global Pulse, satiné (order sample)

► [Configure online on KATALOG.PLANLICHT.COM](#)

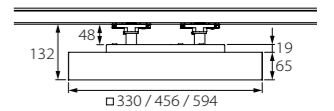
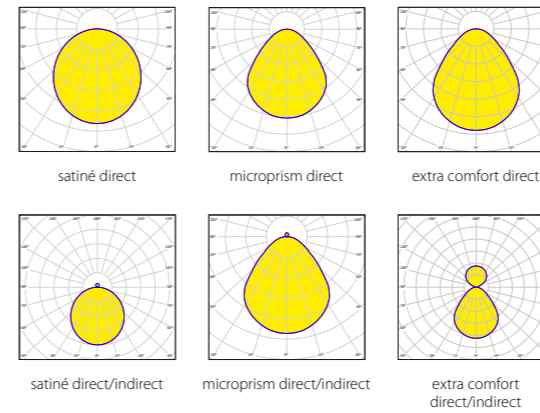

LUMINOUS FLUX (LM) / SYSTEM POWER (W)

	low output CRI > 80	direct		low output CRI > 80	direct / indirect	
		high output CRI > 80	dynamic white CRI > 90		high output CRI > 80	dynamic white CRI > 90
330 x 330 mm	1469 lm / 10,5 W	2653 lm / 18,5 W	2057 lm / 18,5 W	-	-	-
456 x 456 mm	2882 lm / 21 W	4603 lm / 33 W	3568 lm / 33 W	3041 lm / 21 W	4855 lm / 33 W	3763 lm / 33 W
594 x 594 mm	4866 lm / 31 W	9137 lm / 59 W	6269 lm / 54 W	5044 lm / 31 W	9472 lm / 59 W	6529 lm / 54 W

COMPARE COVER 456 x 456 MM, 4000 K, CRI > 80, LOW OUTPUT

	low output CRI > 80	direct		low output CRI > 80	direct / indirect	
		high output CRI > 80	dynamic white CRI > 90		high output CRI > 80	dynamic white CRI > 90
satiné	2882 lm	4603 lm	3568 lm	3041 lm	4855 lm	3763 lm
microprism	2501 lm	3995 lm	3097 lm	2660 lm	4247 lm	3292 lm
extra comfort	3115 lm	4976 lm	3857 lm	3238 lm	5171 lm	4008 lm

WEIGHT

	direct	direct / indirect
330 x 330 mm	2,7 kg	-
456 x 456 mm	3,9 kg	3,9 kg
594 x 594 mm	5,7 kg	5,7 kg

(based on optic S, DALI)

*Die angegebenen Lichtstromwerte (lm) beziehen sich auf Leuchten mit einem weißen Gehäuse (RAL 9016). Je nach Gehäusefarbe reduzieren sich diese entsprechend.
All figures of luminous flux (lm) are for fixtures with white housing (RAL 9016). Depending on the housing colour, the luminous flux is reduced accordingly.
Les valeurs de flux lumineux (lm) indiquées se réfèrent aux luminaires à corps blanc (RAL 9016). En fonction de la couleur du corps, celles-ci sont réduites en conséquence.



Down to UGR ≤ 19 | up to 163 lm/W | IEC 62471: Blue light hazard: RG 0 | DALI

Components non-dim

01 SURFACE-MOUNT TRACK

	1000mm	676001AL
	1000mm	676001SW
	1000mm	676001WS
	2000mm	676002AL
	2000mm	676002SW
	2000mm	676002WS
	3000mm	676003AL
	3000mm	676003SW
	3000mm	676003WS
	4000mm	676004AL
	4000mm	676004SW
	4000mm	676004WS

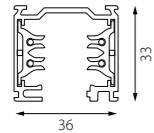

02 END CAP

	676011SI
	676011SW
	676011WS

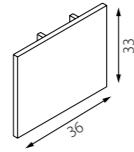

03 LINEAR CONDUCTIVE CONNECTOR

	676006SW
	676006WS

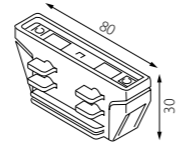

leitend
conductive
conducteur
conduttivo

16 SUSPENSION ROPE

	2000mm	676014SW
	2000mm	676014WS
	6000mm	676016SW
	6000mm	676016WS

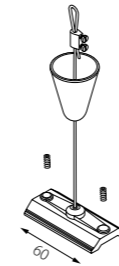

für Deckenhaken
for ceiling hooks
pour crochet au plafond

17 WITH CEILING MOUNTS

	2000mm	676026WS
	6000mm	676026WS-6

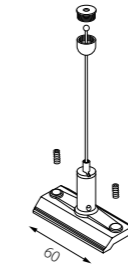

Inklusive Schnellspanner unten.
Include the quick release below.
Tendeurs rapides ci-dessous inclus.

04 CLAMP

	676013
--	--------

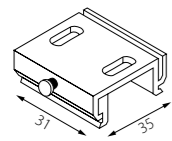

05 LINEAR NON-CONDUCTIVE CONNECTOR

	676023
--	--------

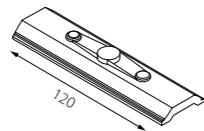

06 CENTRAL POWER FEED

	676007SI
	676007SW
	676007WS

07 POWER END FEED

	676004LSI
	676004LSW
	676004LWS

08 POWER END FEED

	676004RSI
	676004RSW
	676004RWS

09 COVER

	1000mm	676019SW
	1000mm	676019WS

10 X-CONNECTOR

	676022SI
	676022SW
	676022WS

11 FLEXIBLE CONNECTOR

	676010SI
	676010SW
	676010WS

12 T-CONNECTOR

	676012LSI
	676012LSW
	676012LWS
	676012RSI
	676012RSW
	676012RWS

13 L-CONNECTOR

	676008LSI
	676008LSW
	676008LWS
	676008RSI
	676008RSW
	676008RWS

14 CLIP CADDY T-RAIL

	SB0760
--	--------

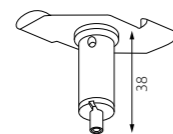

26 mm mit Schnellspanner,
für Stahlseil 1 mm.
26 mm with quick release,
for steel cable 1 mm.
26 mm tendeur rapide inclus,
pour câble en acier 1 mm.

15 CEILING ATTACHMENT WITH QUICK RELEASE

	26 mm, with quick release for steel rope 1 mm	B57100
--	--	--------

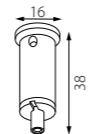

für Stahlseil 1 mm
for steel rope 1 mm
pour câble en acier 1 mm

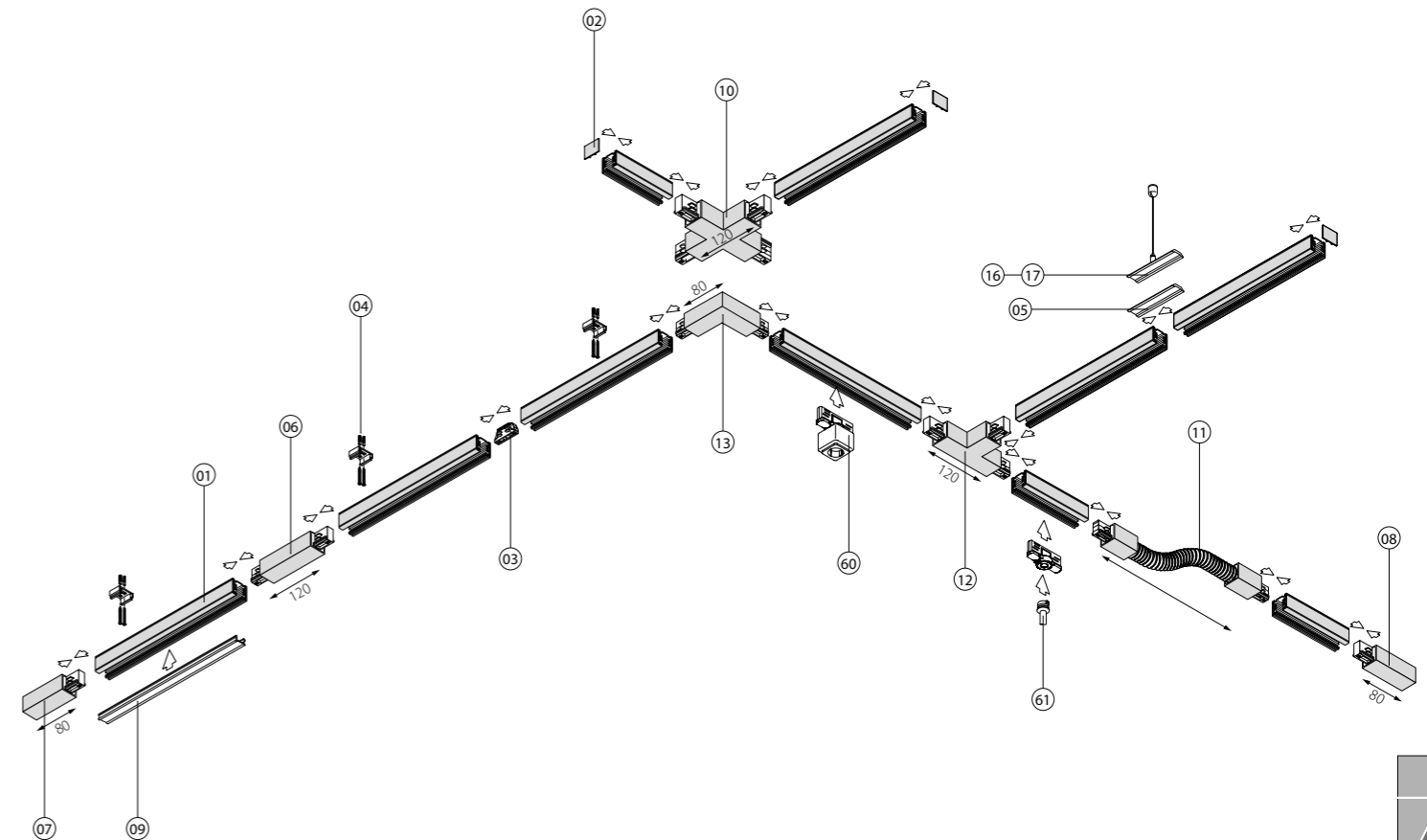

	left
	right
	inside
	outside
	silver
	black
	white
	chrome



Components non-dim

21 RECESSED TRACK

	1000 mm	679001AL
	1000 mm	679001SW
	1000 mm	679001WS
	2000 mm	679002AL
	2000 mm	679002SW
	2000 mm	679002WS
	3000 mm	679003AL
	3000 mm	679003SW
	3000 mm	679003WS
	4000 mm	679004AL
	4000 mm	679004SW
	4000 mm	679004WS

22 END CAP

		677659I00W20
		677659I00W30
		677659I00W31

CUT OUT
↕ 37 mm

23 CENTRAL POWER FEED

	679007SI
	679007SW
	679007WS

24 POWER END FEED

	679004LSI
	679004LSW
	679004LWS
	679004RSI
	679004RSW
	679004RWS

03 LINEAR CONDUCTIVE CONNECTOR

	676006SW
	676006WS

leitend
conductive
conducteur
conduttivo

05 LINEAR NON-CONDUCTIVE CONNECTOR

	676023
--	--------

09 COVER

	1000 mm	676019SW
	1000 mm	676019WS

10 RECESSED HOUSING FOR MONOPOINT

	424-9000-BRU-B
	424-9000-BRU-W

Adapter für Basis 9000-BPU
Adapter for base 9000-BPU
Adaptateur pour la base 9000-BPU

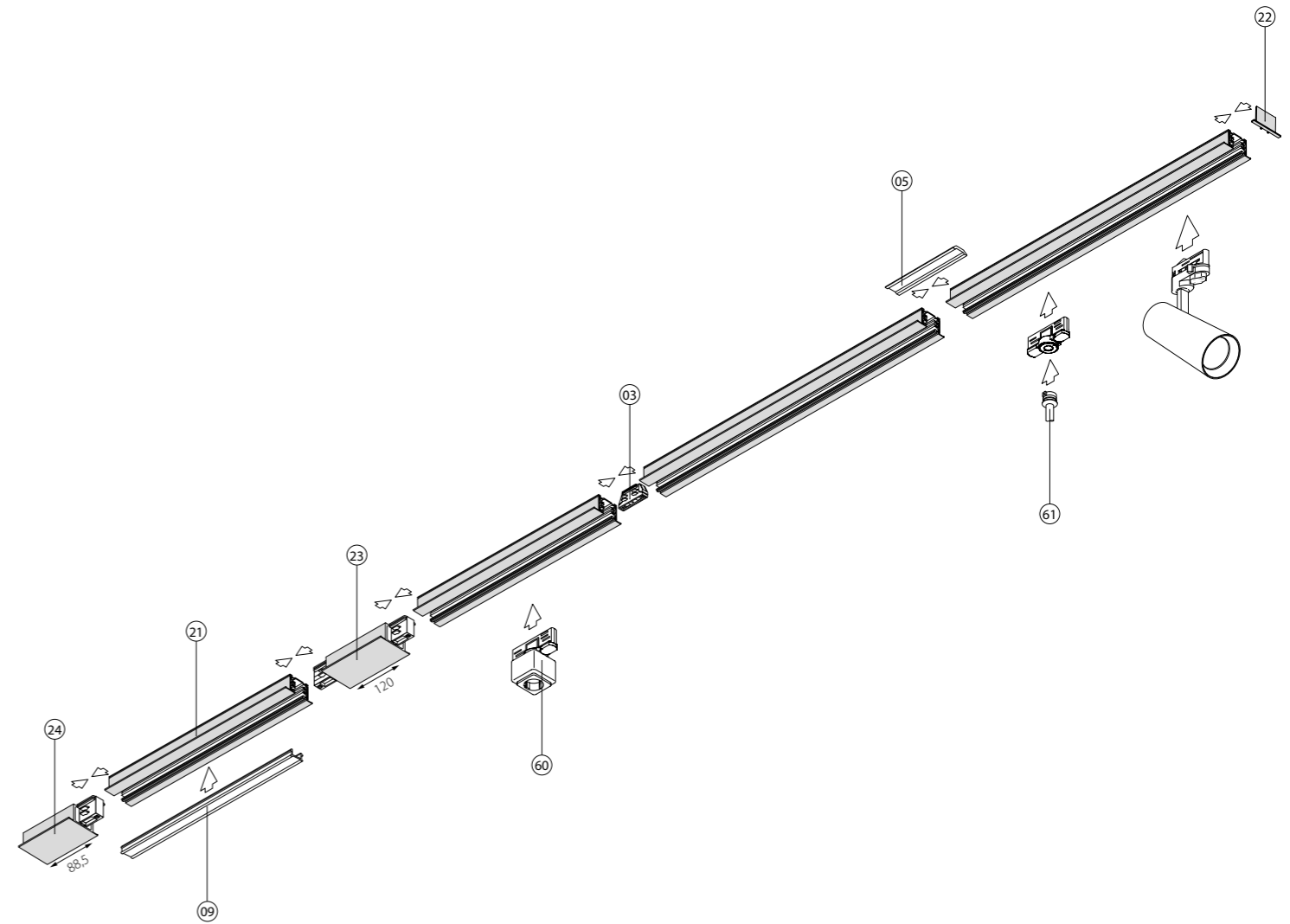
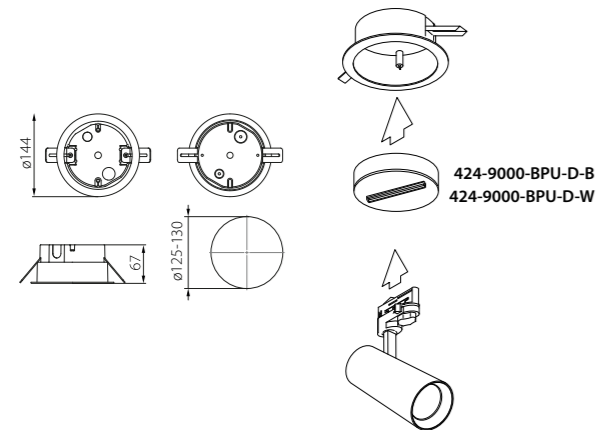
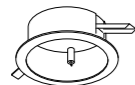

	left
	right
	silver
	white
	black



01 SURFACE MOUNTED TRACK

	1000 mm	424-9000A-1-G-ST
	1000 mm	424-9000A-1-B-ST
	1000 mm	424-9000A-1-W-ST
	2000 mm	424-9000A-2-G-ST
	2000 mm	424-9000A-2-B-ST
	2000 mm	424-9000A-2-W-ST
	3000 mm	424-9000A-3-G-ST
	3000 mm	424-9000A-3-B-ST
	3000 mm	424-9000A-3-W-ST
	4000 mm	424-9000A-4-G-ST
	4000 mm	424-9000A-4-B-ST
	4000 mm	424-9000A-4-W-ST

02 CUTTING TOOL

424-S-9000-T

Schneidewerkzeug für Kupfer.
Cutting tool for track copper.
Outil de coupe pour les cuivre.

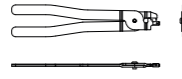
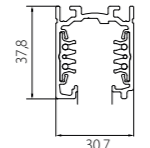
03 COVER

	424-9000-GP-G
	424-9000-GP-B
	424-9000-GP-W

Zusätzlicher Abdeckstreifen für Schiene.
Additional cover strip for track.
Bande de recouvrement supplémentaire pour le rail.

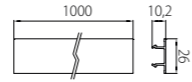

13 SUSPENSION KIT

	3000 mm	424-9000-KIT8-3
	3000 mm	424-9000-KIT8-3-B
	3000 mm	424-9000-KIT8-3-W

Inklusive Deckenbefestigung mit rundem Kopf, Stahlseil $\varnothing 1,5$ mm mit kugelförmigem Ende, Bügel mit Schnellspanner.
Includes round head ceiling attachment, steel cable $\varnothing 1,5$ mm with spherical end, bracket with quick release.
Comprend une fixation au plafond à tête ronde, un câble en acier $\varnothing 1,5$ mm avec extrémité sphérique, un support avec libération rapide.



14 CEILING BRACKET

	424-S-9000-131
	424-S-9000-131-B
	424-S-9000-131-W

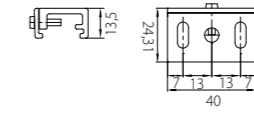

15 PENDING SUSPENSION

	424-S-9000-P6-SB
	424-S-9000-P6-SW

Beinhaltet Deckenhalterung, Baldachin ($\varnothing 100$ mm), M13 Gewindestange (L=1200mm) mit Gegenmutter.
Includes ceiling bracket, canopy ($\varnothing 100$ mm), M13 threaded stem (L=1200mm) with counter-nut.
Comprend un support de plafond, canopée ($\varnothing 100$ mm), une tige filetée M13 (L=1200mm) avec contre-écrou.

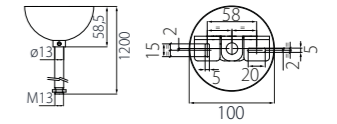

04 POWER END FEED

	424-9001-G
	424-9001-B
	424-9001-W
	424-9002-G
	424-9002-B
	424-9002-W

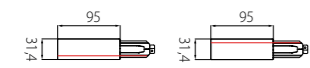

05 MIDDLE POWER FEED

	424-9010-G
	424-9010-B
	424-9010-W

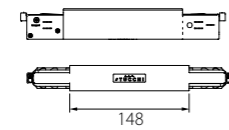

06 END CAP

	424-9004-G
	424-9004-B
	424-9004-W

Endkappe mit Feststellschraube.
End cap with locking screw.
Capuchon d'extrémité avec vis de blocage.

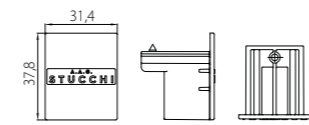

16 RAIL CONNECTOR

	424-S-9000-332-SV
	424-S-9000-332-SV-B
	424-S-9000-332-SV-W

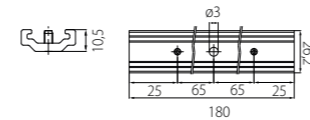

17 M13 CLIP FOR PENDING SUSPENSION

	424-S-9000-322-M13-B
	424-S-9000-322-M13-W

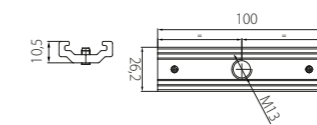

18 MONOPOINT

	424-9000-BPU-D-B
	424-9000-BPU-D-W

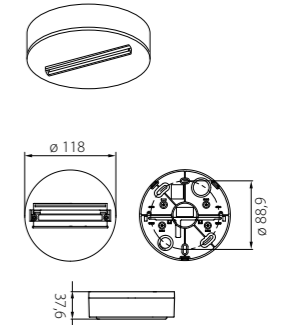

07 LINEAR CONDUCTIVE CONNECTOR

	424-9003-G
	424-9003-B
	424-9003-W

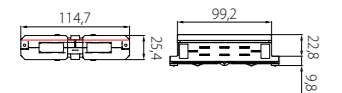

08 LINEAR NON-CONDUCTIVE CONNECTOR

	424-9003-G-M
	424-9003-B-M
	424-9003-W-M

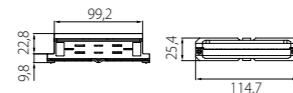

09 L-CONNECTOR

	424-9011-G
	424-9011-B
	424-9011-W
	424-9012-G
	424-9012-B
	424-9012-W

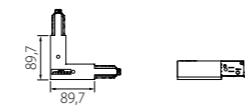

10 T-CONNECTOR

	424-9013-G
	424-9013-B
	424-9013-W
	424-9014-G
	424-9014-B
	424-9014-W
	424-9015-G
	424-9015-B
	424-9015-W
	424-9016-G
	424-9016-B
	424-9016-W

11 X-CONNECTOR

	424-9017-G
	424-9017-B
	424-9017-W

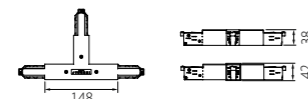
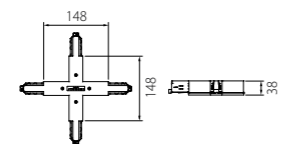

12 FLEXIBLE CONNECTOR

	424-9018-G
	424-9018-B
	424-9018-W

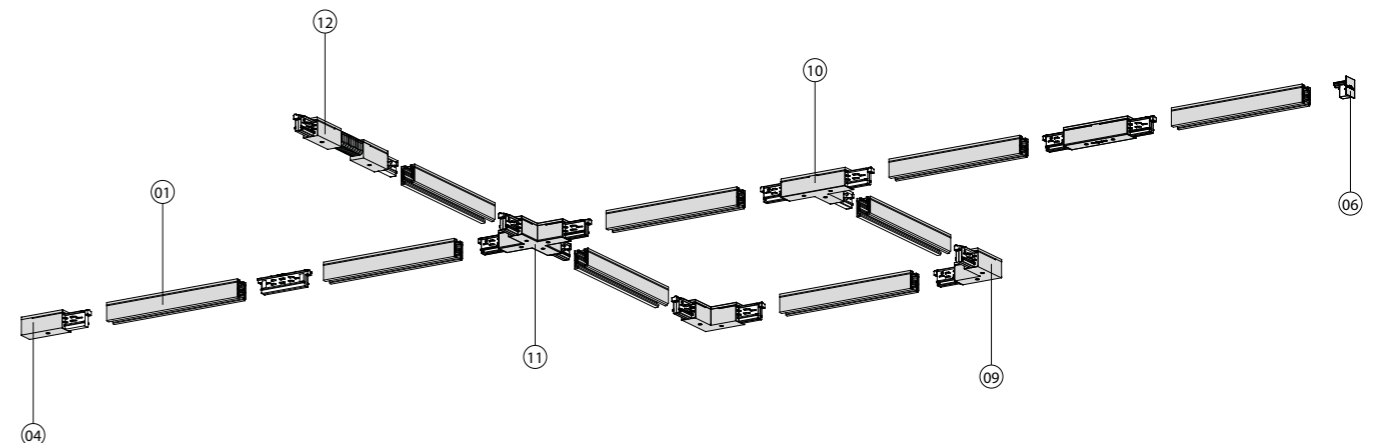
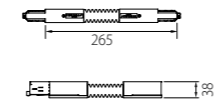

- inside
- outside
- left
- right
- grey
- black
- white
- zinc

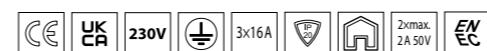

Component Stucchi DALI OneTrack

18 RECESSED TRACK

	1000mm	424-9000-1-B-R
	1000mm	424-9000-1-W-R
	2000mm	424-9000-2-B-R
	2000mm	424-9000-2-W-R
	3000mm	424-9000-3-B-R
	3000mm	424-9000-3-W-R

19 CUTTING TOOL

424-S-9000-T

Schneidewerkzeug für Kupfer.
Cutting tool for track copper.
Outil de coupe pour les cuivre.

20 COVER

	424-9000-GP-B
	424-9000-GP-W

Zusätzlicher Abdeckstreifen für Schiene.
Additional cover strip for track.
Bande de recouvrement supplémentaire pour le rail.

21 END CAP

	424-9004-R-B
	424-9004-R-W

Endkappe mit Feststellschraube.
End cap with locking screw.
Capuchon d'extrémité avec vis de blocage.

22 LINEAR CONDUCTIVE CONNECTOR

	424-9003-B
	424-9003-W

23 LINEAR NON-CONDUCTIVE CONNECTOR

	424-9003-B-M
	424-9003-W-M

24 COVER FOR POWER END FEED

	424-S-9001-R-6-B
	424-S-9001-R-6-W

25 COVER FOR MIDDLE POWER FEED

	424-S-9010-R-6-B
	424-S-9010-R-6-W

26 COVER FOR L-CONNECTOR

	424-S-9011-R-6-B
	424-S-9011-R-6-W

27 POWER END FEED

	424-9001-B
	424-9001-W
	424-9002-B
	424-9002-W

28 MIDDLE POWER FEED

	424-9010-B
	424-9010-W

29 L-CONNECTOR

	424-9011-B
	424-9011-W

30 COVER FOR T-CONNECTOR

	424-S-9013-R-6-B
	424-S-9013-R-6-W
	424-S-9017-R-6-B
	424-S-9017-R-6-W

31 T-CONNECTOR

	424-9013-G		424-9015-G
	424-9013-B		424-9015-B
	424-9013-W		424-9015-W
	424-9013-G		424-9016-G
	424-9014-B		424-9016-B
	424-9014-W		424-9016-W

32 T-BRACKET

	424-S-9000-313-B
	424-S-9000-313-W
	424-S-9000-313

Kurzer T-Bügel für Aufhängungen.
Short T bracket for suspensions.
Support en T court pour les suspensions.

33 RAIL CONNECTOR

	424-S-9000-332-SV-B
	424-S-9000-332-SV-W
	424-S-9000-332-SV

34 RECESSED HOUSING FOR MONOPOINT

	424-9000-BRU-B
	424-9000-BRU-W

Adapter für Basis 9000-BPU
Adapter for base 9000-BPU
Adaptateur pour la base 9000-BPU

424-9000-BPU-D-B
424-9000-BPU-D-W

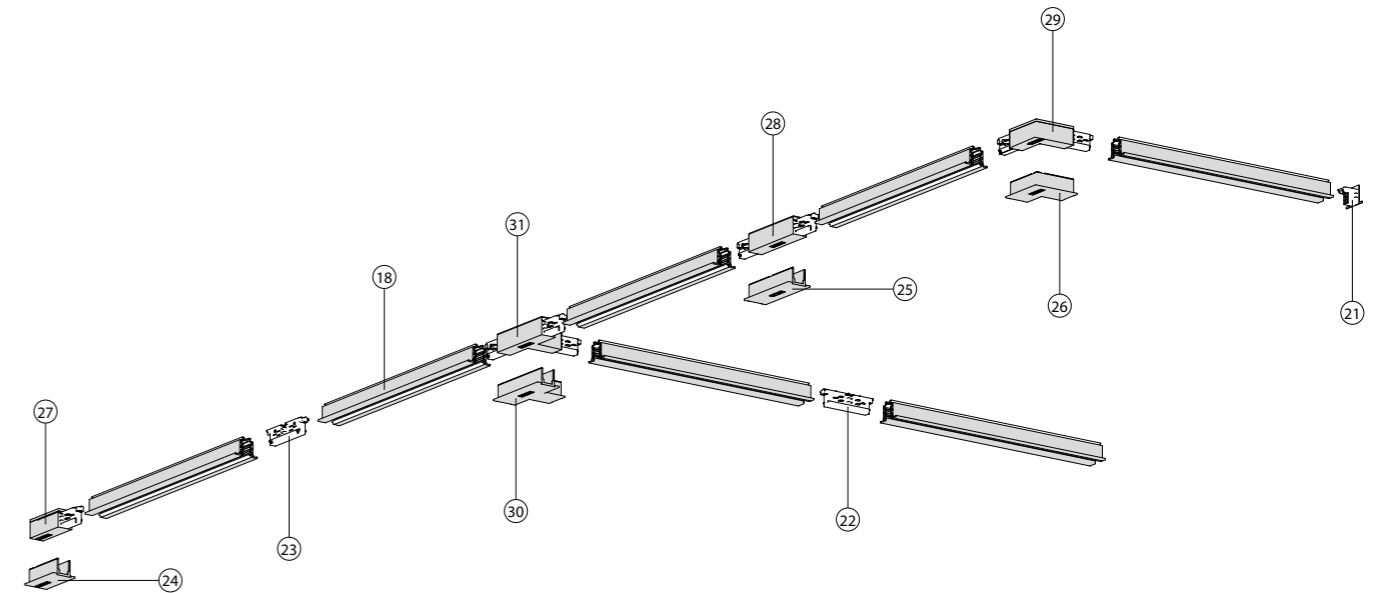

- left
- right
- black
- white
- zinc

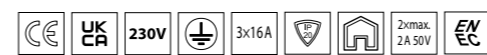

Components - adapters

03 STUCCHI INSTALLATION TOOL

424-S-9009-T-INS

Einbauwerkzeug-Einsatz für Adapterverdrahtung.
Installation tool insert for adapter wiring.
Outil d'installation pour le câblage de l'adaptateur.

STUCCHI SUSPENSION HOOK

424-S-9000-H-B

424-S-9000-H-W

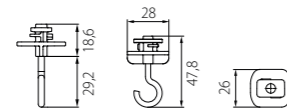

04 STUCCHI MOUNTING NIPPLE

424-S-9009-M10

424-S-9009-M13

M10 und M13 aus Aluminium, zur Aufnahme von Spots.
M10 and M13 made of aluminium, for holding spots.
M10 et M13 en aluminium, pour l'installation de spots.

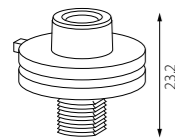

05 STUCCHI MOUNTING NIPPLE FOR CABLE

424-S-9009-BC-B

424-S-9009-BC-W

Für Mantelleitung, DALI-Mantelleitung, inkl. Zugentlastung aus Aluminium.
For sheathed cable, DALI sheathed cable, incl. strain relief made of aluminium.
Pour conducteur sous gaine, Gaine DALI avec dispositif de décharge de traction de câble en aluminium.

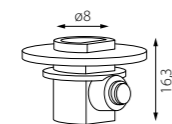

61 STUCCHI MOUNTING NIPPLE M10

424-S-9009-M10-FI

Nippel mit M10 Innengewinde für Adapter 9009, 9209, 9409.
Nipples with M10 internal thread for adapters 9009, 9209, 9409.
Embouts avec filetage interne M10 pour adaptateurs 9009, 9209, 9409.

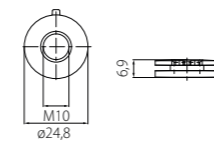

60 EUTRAC SCHUKO-ADAPTER

71990952

71990956

Für den Anschluss von Geräten der Schutzklasse I (System Schuko) bzw. universell einsetzbar für Geräteflächstecker Schutzklasse II, für Netzspannung 220-240V mit Sicherung 6,3A, träge.
For the connection of devices of protection class I (System Schuko) or universally applicable for flat plugs of protection class II, for mains voltage 220-240V with fuse 6,3A, slow.
Pour le raccordement d'appareils de classe de protection I (système Schuko / prise de type F) ou de prises plates d'appareils de classe 2. Pour tension de réseau 220-240V, avec fusible temporisé 6,3A.

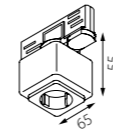

01 STUCCHI MULTI-DALI ADAPTER

424-9009-B

424-9009-W

Für Datenbusschiene, kompatibel mit: AAG-Stucchi mit Datenbus und Nordic/Global Track Pulse.
For data bus rail, compatible with: AAG-Stucchi with data bus and Nordic / Global Track Pulse.
Pour rail de avec bus données, compatible avec: AAG-Stucchi avec bus de données et Nordic / Global Track Pulse.

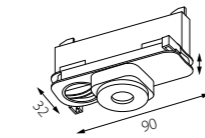

02 STUCCHI NON-DIM ADAPTER

424-9009-4-B

424-9009-4-W

Universal-Adapter für nicht dimmbare 3-Phasen Schiene.
Universal adapter for non-dimmable 3-phase rail.
Adaptateur universel pour rail triphasé non graduable.

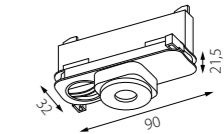

3 PHASE ADAPTER COMPATIBILITY

zenit M		meteor	
1	G	1	G
non-dim	Stucchi OneTrack	non-dim	Stucchi OneTrack
STUCCHI	STUCCHI	Powergear	STUCCHI

Einsetzbar in folgenden Schienen. Es handelt sich hier nur um eine Empfehlung, es wird weder von planlicht, noch vom Hersteller Garantie übernommen.
Can be used on the following tracks. This is only for information, planlicht nor the manufacturer will warranty any claim when not used in an approved track.
Compatibles avec les rails suivants. Les informations ci-après sont uniquement données à titre indicatif. planlicht et le fabricant déclinent toute garantie.

Ivela, Eutrac, Stucchi, Global, Unipro	Stucchi DALI, DALI Global Track Pulse Control, Unipro	Ivela, Eutrac, Stucchi, Global, Unipro	Stucchi DALI, DALI Global Track Pulse Control, Unipro
--	---	--	---

black
white
aluminium

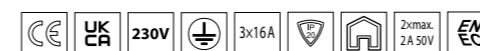

FEATURES & ZUBEHÖR

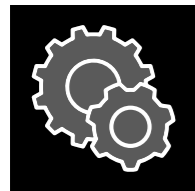

Features & additional equipment
Équipements supplémentaires

STEUERUNGEN | CONTROLS | CONTRÔLES



RADIO
430

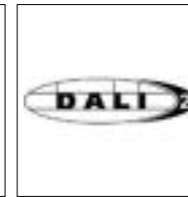

DALI
432

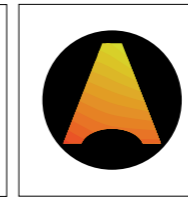

CASAMBI
435

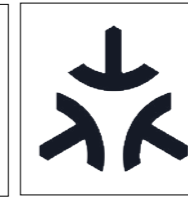

MATTER
438

BETRIEBSGERÄTE | CONTROL GEAR | UNITÉS DE CONTRÔLE

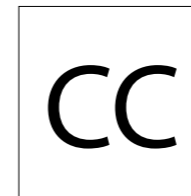

CC CONVERTER
441



CV CONVERTER
444

SANIERUNGSKIT | REFURBISHMENT KITS | KIT DE RÉNOVATION

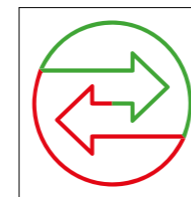

PURE 1, PURE 2
448

NOTLICHT, SENSOREN, AKUSTIK | EMERGENCY LIGHT, SENSORS, ACOUSTIC | LUMIÈRE D'URGENCE, CAPTEURS, ACOUSTIQUE



452

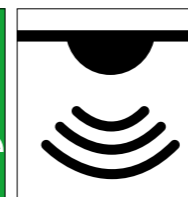

453



454

PLANLICHT vertreibt Steuerungen & Betriebsgeräte renommierter Hersteller und integriert diese zudem in die Lichtlösungen.
PLANLICHT distributes controls and drivers from reputable manufacturers and also integrates these into the lighting solutions.



RADIO CONTROLS



Technologie
Funk, kabellos

Technology
Radio, wireless



Anwendungsbereiche
24V DC LED-Bänder (1-4 Kanäle, einfarbig, dynamisch weiß, RGB, RGBW)

Application areas
24V DC LED strips (1-4 channels, monochrome, dynamic white, RGB, RGBW)

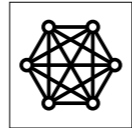

Komplexität
Keine Vorkenntnisse notwendig

Complexity
No prior knowledge required

RADIO CONTROL 24V (1-4 channel)
1-4 channel radio control
2,4GHz, 4 x max. 2,5 A (240W total)

24V/DC

45AA40PDLU0000B



REMOTE CONTROL
1/2 channel remote control
2,4 GHz (DIM, tunable white)

Dimension
LxWxH= 150x40x20 mm

45AA40RCDIMCTON



REMOTE CONTROL
3/4 channel remote control
2,4 GHz (RGB, RGBW)

Dimension
LxWxH= 150x40x20 mm

45AA40RCRWBW00N



TOUCH PANELS FOR RADIO CONTROL
1 channel DIM radio touch panel
2,4 GHz

230V/AC
Dimension
LxWxH= 150x40x20 mm

45AA40WALLDIM2B



TOUCH PANELS FOR RADIO CONTROL
2 channel TW radio touch panel
2,4 GHz

230V/AC
Dimension
LxWxH= 150x40x20 mm

45AA40WALLCT20B

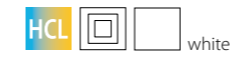

TOUCH PANELS FOR RADIO CONTROL
3 channel RGB radio touch panel
2,4 GHz

230V/AC
Dimension
LxWxH= 150x40x20 mm

45AA40WALLRGB2B

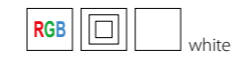

TOUCH PANELS FOR RADIO CONTROL
4 channel RGBW radio touch panel.
2,4 GHz

230V/AC
Dimension
LxWxH= 150x40x20 mm

45AA40WALLRGBWB

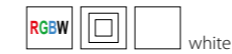



DALI CONTROLS

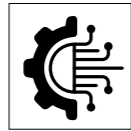

Technologie

Digitales Protokoll, kabelgebunden (2x 1,5 mm²)

Technology

Digital protocol, wired (2 x 1.5 mm²)

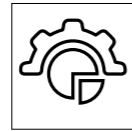

Anwendungsbereiche

Alle Anwendungsgebiete bis maximal 64 Adressen

Application areas

All application areas up to a maximum of 64 addresses

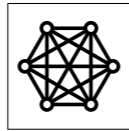

Komplexität

Einsteigerfreundlich bis komplex

Complexity

Beginner-friendly to complex

DALI MCU TW G2

230V / AC IP20
Dimension
LxWxH=80x80x50 mm

540-224673



DALI Steuereinheit mit integrierter Spannungsversorgung (52mA) für Standard DALI und DALI DT8 Anwendungen. Drehpotentiometer integriert, bis zu 4 DALI PCU in einem DALI Kreis möglich. Synchronisation erfolgt automatisch. Einfache Speicherung der Einschaltelligkeit (Doppelklick).

DALI control unit with integrated power supply (52mA) for standard DALI and DALI DT8 applications. Integrated rotary potentiometer, up to 4 DALI PCU in one DALI circuit possible. Automatic synchronisation and simple storage of the switch-on brightness (double-click).



DALI PCU TW G2

230V / AC IP20
Dimension
LxWxH=48x49x22 mm
2x push-button connections (2nd only for DT8 applications, length of 15cm, up to 1m possible)

540-631625

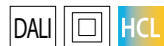

DALI Steuereinheit mit integrierter Spannungsversorgung (52mA) für Standard DALI und DALI DT8 Anwendungen. Kann mit jedem handelsüblichen Taster (Schließer) betrieben werden. Bis zu 4 DALI PCU in einem DALI Kreis möglich. Synchronisation erfolgt automatisch. Einfache Speicherung der Einschaltelligkeit (Doppelklick).

DALI control unit with integrated power supply (52mA) for standard DALI and DALI DT8 applications. Can be operated with any commercially available push-button (NO contact). Up to 4 DALI PCU in one DALI circuit possible. Automatic synchronisation and simple storage of the switch-on brightness (double-click).



DALI XC

DALI controller with up to 4 push-button inputs
current consumption 6mA
DALI Steuermodul mit bis zu vier Tast-/Schalteingängen

3528001716



DALI TOUCHPANEL LUNATONE

Dimension
LxWxH=82,5x111x8,5 mm

429-24035465-BT

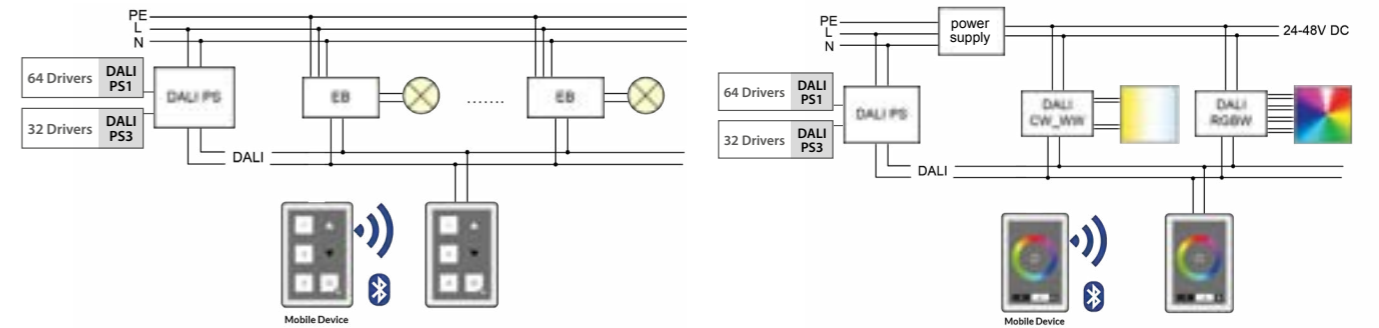
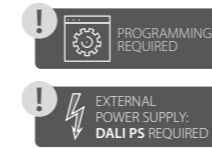

DALI-2 Display 7" Touchpanel

Dimension
LxWxH=178x111x8 mm

429-86456840-W - DALI-2 Display 7" Touchpanel
429-86456840-P-W - DALI-2 Display 7" Plus Touchpanel



Multifunktionales 7" Dali-2 Touchpanel (24-Bit Farbtiefe) zur Ansteuerung von bis zu 64 Einzeladressen und 16 Gruppen. Zusätzlich geeignet für DT8 Tunable-white und RGB-Anwendungen. Individuell gestaltbare Widget-Bedienoberfläche. Integrierte Sensoren zur Visualisierung von Temperatur, Luftqualität, Luftdruck und Luftfeuchtigkeit. Zur Installation an Unterputzdose, Stromversorgung über 24-56V DC oder Power over Ethernet (POE), Leistungsaufnahme 3,5W. Auslieferung erfolgt mit Werkseinstellungen.

„Plus“-Ausführung: Zusätzlich integrierte Maske zur Adressierung und Inbetriebnahme eines DALI-Systems. Programmierbare zirkadiane Tageslichtfarbverläufe und Timer-Funktionen

Benötigt 24V DC Spannungsversorgung (min. 3,5W), z.B. PMR24 24V

Multifunctional 7" Dali-2 Touchpanel (24-bit color depth) for controlling up to 64 individual addresses and 16 groups. Additionally suitable for DT8 Tunable-white and RGB applications. Customizable widget-based user interface. Integrated sensors for displaying temperature, air quality, air pressure, and humidity. Designed for installation in wall boxes, powered by 24-56V DC or Power over Ethernet (POE), power consumption of 3.5W. Shipped with factory settings.

„Plus“ version: Additionally includes an integrated mask for addressing and commissioning a DALI system. Programmable circadian daylight color transitions and timer functions.

Requires 24V DC power supply (min. 3.5W), e.g., PMR24 24V.

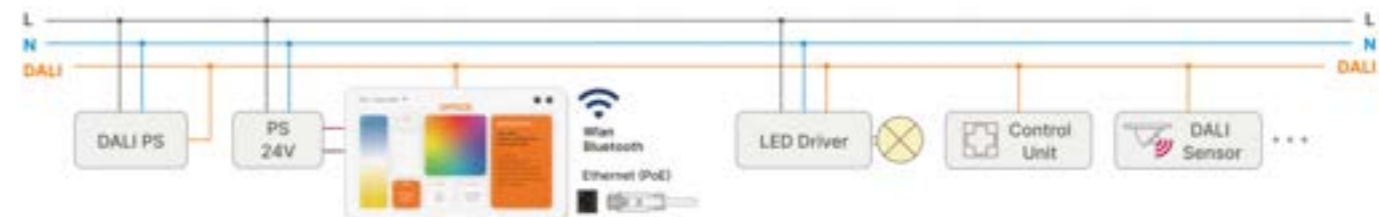

DALI PS3 DALI Stromversorgung für bis zu 70 mA
DALI power supply providing 70 mA **3587500873**

32 Drivers DALI PS3

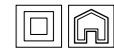

220 - 240V AC



DALI PS1 DALI Stromversorgung für bis zu 200 mA
DALI power supply providing 200 mA **3524034323**

64 Drivers DALI PS1

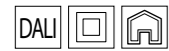

220 - 240V AC



DALI USB Dimension LxWxH=101,5x51x29,5 mm
Current consumption 10 mA **3524138923**



DALI-USB Schnittstelle zur Adressierung von DALI Betriebsgeräten über die Software Master Configurator.

DALI-USB interface for addressing and parameterizing a DALI installation.

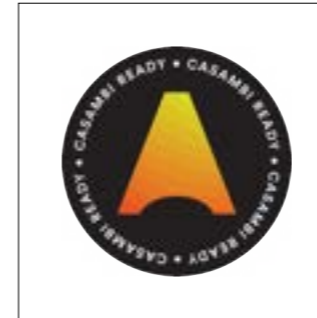
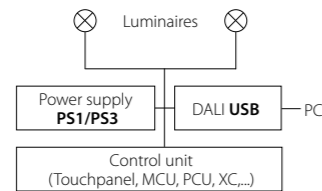

CASAMBI Bluetooth Controls

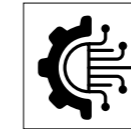

Technologie

Bluetooth, kabellos

Technology

Bluetooth, wireless



Anwendungsbereiche

Alle Anwendungsgebiete bis 125 Geräte

Application areas

All application areas up to 125 devices

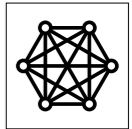

Komplexität

Einsteigerfreundlich bis komplex

Complexity

Beginner-friendly to complex

basicDIM Wireless Modul G2
Bluetooth 4.0, 230V / AC
Control unit for max. 5 LED converters
(max. 10 mA / DC)

Dimension
LxWxH=80,7x30x15,3 mm

3528003540



DALI 2
220 - 240V AC

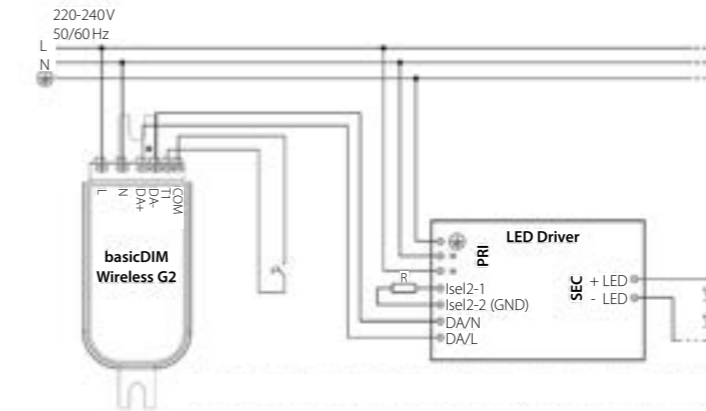

basicDIM Wireless Modul Passive G2
Bluetooth 4.0
Passive DALI-2 control unit without integrated DALI power supply
current consumption 4mA

Dimension
LxWxH=80,7x30x15,3 mm

3528003541



DALI 2

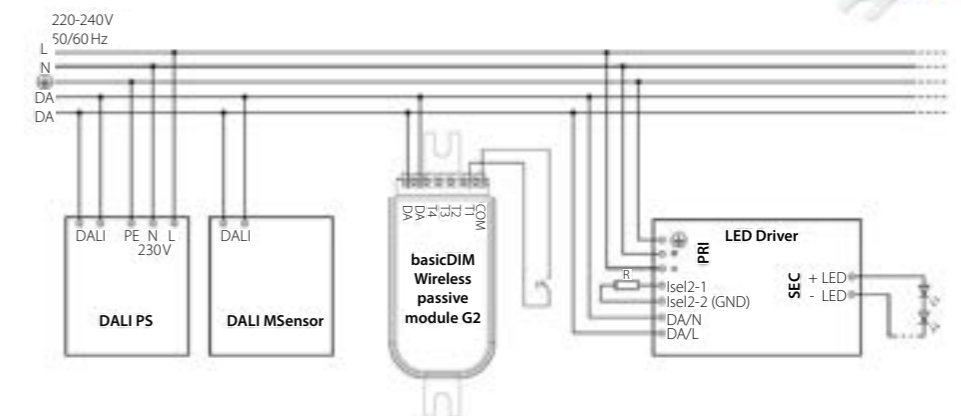

MSensor G3 PIR SDPI
 (optional accessory to basicDIM Wireless
 Modul Passive G2)
 current consumption 9mA

3528002384
3528002386
3528002878 (Surface mounting kit for
 3528002384)



basicDIM Wireless SR
 Bluetooth 4.0, 230V/AC
 Control unit for max. 25 LED converters
 (max. 50mA/DC)

Dimension
 LxWxH=119x30x21 mm

3528004484



DALI 2
 220-240V AC

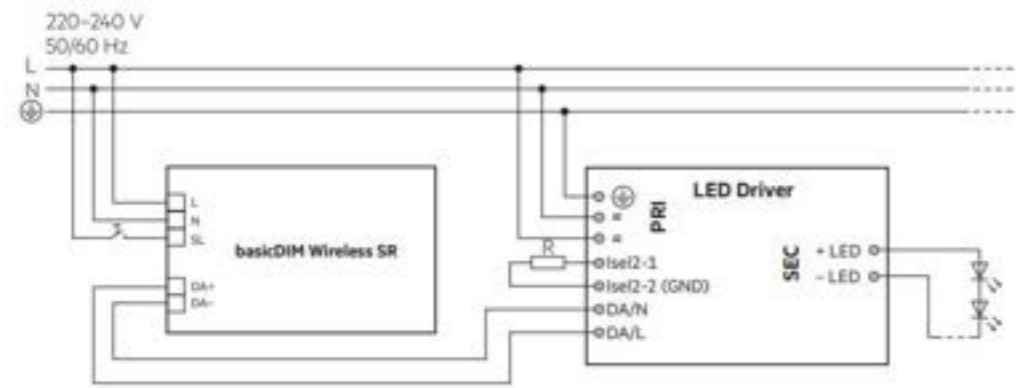
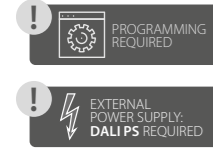

Strain relief set for basicDIM Wireless SR

(optional) **3528000881**



CBU-TED

85-240 V/ AC
 Dimension
 LxWxH=40,4x36,3x14 mm

420-CBU-TED



Bluetooth gesteuerter Dimmer für Phasen- und
 -abschnittsdimmung. Bis zu 150W Gesamtlast. Ideal
 geeignet zur Signalverstärkung.
*Bluetooth controllable control gear for phase cut
 dimming. Up to 150 W total load. Ideally suited for
 signal amplification.*

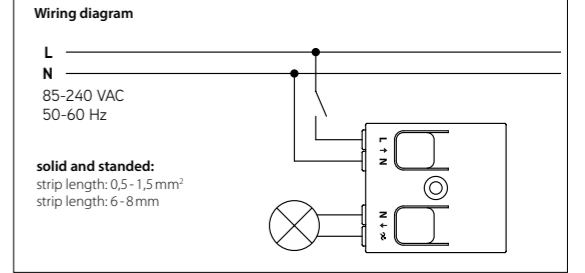

CBU-PWM4

BLUETOOTH 4.0, 12-24V DC

Bluetooth 4.0 PWM controllable dimmer.
 1-4 channels, 12-24V DC, max. 6 A total.

Dimension
 LxWxH=76,2x30x18 mm

420-CBU-PWM4

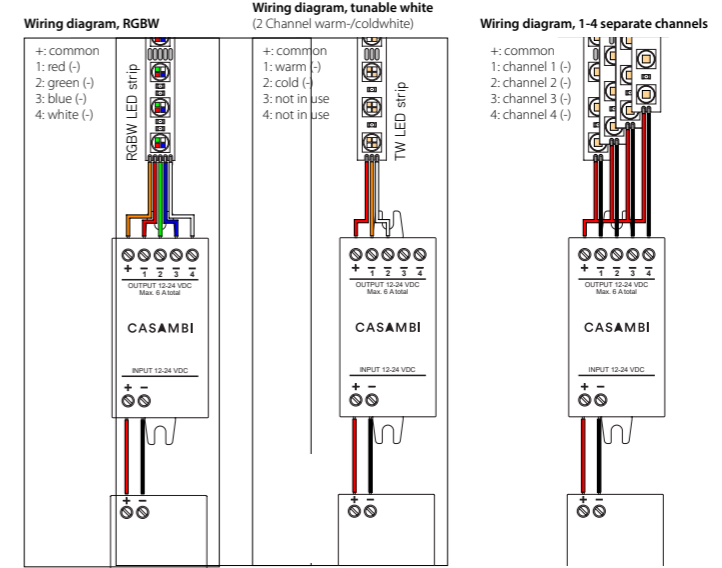

XPRESS

Dimension
 LxWxH=90x90x12 mm

420-XPRESS-W white
420-XPRESS-B black



Wandschalter wireless. Batterie (CR2430 Lithium-Knopfzelle) inkludiert.
 Wandtaster wird magnetisch an einer Montageplatte befestigt, kann abgenommen und als
 Fernbedienung benutzt werden.
*Wireless wall switch. Incl. battery (CR2430 Lithium-ion). The switch is magnetically attached to a
 mounting plate. Can also be detached and used as a remote control.*



EnOcean Casambi switch

Dimension
 LxWxH=50x50x14 mm

428-E8221-A270
428-E8221-A280



Kabelloser, batterieloser Wandschalter.
 Konfiguration individuell durch App.
 Einfache Montage mit inkludiertem doppelseitigen Klebeband oder
 Verschraubung des Rahmens.
*Wireless, battery-free switch. Configuration individual by app.
 Easy installation with included double-sided tape or screw joint.*



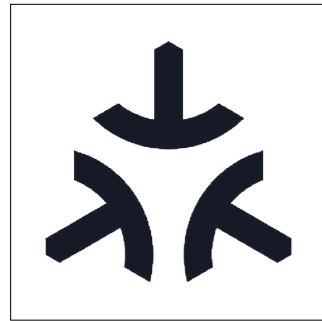

MATTER

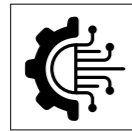

Technologie
Thread, kabellos

Technology
Thread, wireless



Anwendungsbereiche
Smart Home Systeme (Amazon Alexa, Apple HomeKit, Google Home und andere Matter-kompatible Systeme)

Application areas
Smart home systems (Amazon Alexa, Apple HomeKit, Google Home, and other Matter-compatible systems)

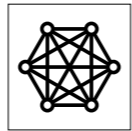

Komplexität
Einsteigerfreundlich

Complexity
Beginner-friendly

Matter-kompatible Steuerungen

Der herstellerübergreifende Verbindungsstandard für das Smart-Home – „Matter“ - fördert die Interoperabilität und sichere Kommunikation verschiedener smarten Ökosysteme und den Endgeräten von unterschiedlichen Herstellern.

Unabhängig davon, ob die Geräte über die Bridge des jeweiligen Herstellers oder über Sprachassistenten wie Amazon Echo oder Google Home verbunden sind: Der Matter-Standard schafft ein Smart Home-Ökosystem für die gemeinsame Nutzung digitaler Haustechnik und ermöglicht die einfache Steuerung.

PLANLICHT führt die Matter-kompatiblen Lichtsteuerungsprodukte von Tridonic (www.tridonic.com).

Matter-compatible controls

The cross-manufacturer connectivity standard for the smart home - „Matter“ - promotes interoperability and secure communication between various smart ecosystems and devices from different manufacturers. Whether the devices are connected through the respective manufacturer's bridge or via voice assistants like Amazon Echo or Google Home, the Matter standard creates a smart home ecosystem for the shared use of digital home technology, enabling easy control.

PLANLICHT offers Matter-compatible lighting control products from Tridonic (www.tridonic.com).



© 2023 Tridonic. All rights reserved.

Wireless Module MTR
IPv6 Thread, 230V/AC
Control unit for max. 5 LED converters
(max. 10mA/DC)
Only for Broadcast DT6 applications

Dimension
LxWxH=80,7x30x15,3 mm

3528004482



→ DALI 2
→ 220-240V AC

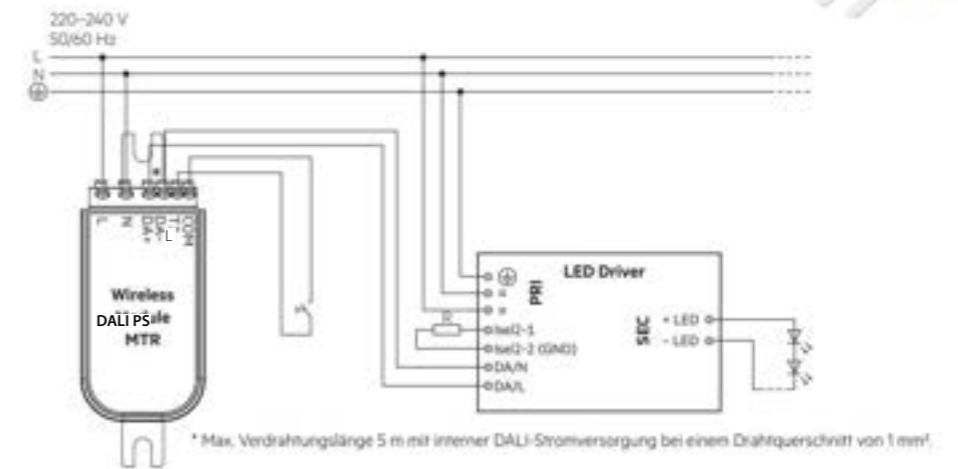

Wireless Module Passive MTR
IPv6 Thread
Passive DALI-2 control unit without integrated DALI power supply
Only for Broadcast DT6 applications
Current consumption 4mA
Also usable as push-button interface

Dimension
LxWxH=80,7x30x15,3 mm

3528004483



→ DALI 2
→ 220-240V AC



e.g. DALI PS3
(3587500873)

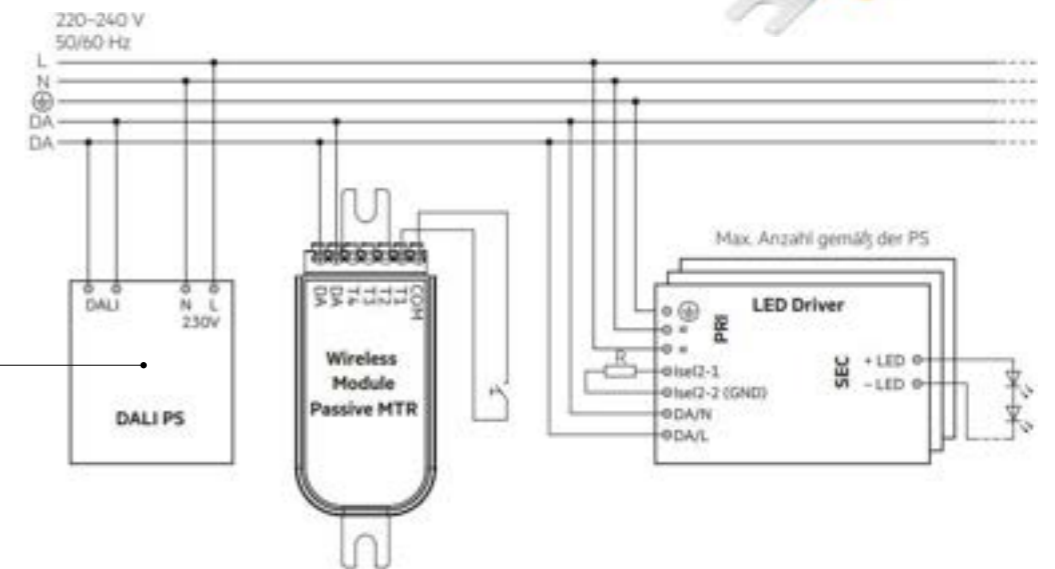

Wireless Module SR MTR
 IPv6 Thread, 230V/AC
 Control unit for max. 25 LED converters
 (max. 50mA/DC)
 Only for Broadcast DT6 applications

Dimension
 LxWxH= 119x30x21 mm

3528004484



DALI 2
 220 - 240V AC

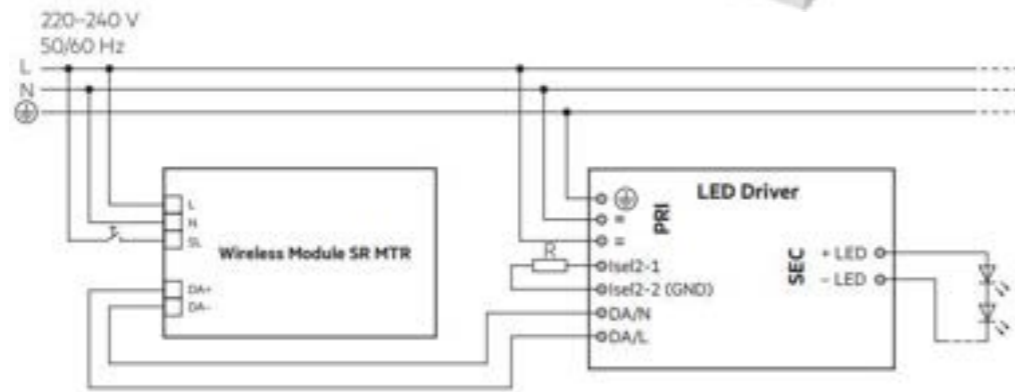

Strain relief set for Wireless Module SR MTR

(optional) 3528000881



LSC4W	45H-LSC4W350LRP-UNI	90-264V/AC	1-3,3W	350 mA/DC	2,7-9,5V/DC	49x27,2x20mm
LSC4W	45H-LSC4W500LRP-UNI	90-264V/AC	1,4-3,2W	500 mA/DC	2,7-6,5V/DC	49x27,2x20mm
LSC7W	45H-LSC7W500LRP	198-264V/AC	3,3-6,5W	500 mA/DC	6,5-13V/DC	49x27,2x20mm
LSC4W	45H-LSC4W700LRP-UNI	90-264V/AC	1,9-3,1W	700 mA/DC	2,7-4,5V/DC	49x27,2x20mm
LSC7W	45H-LSC7W700LRP	198-264V/AC	4,2-7W	700 mA/DC	6-10V/DC	49x27,2x20mm



LSC3W	45H-LSC3W200LR-ZU	90-264V/AC	2,6-3,6W	200mA/DC	13-18V/DC	65x29x18mm
LSC3W	45H-LSC3W350LR-ZU	90-264V/AC	1-3,5W	350 mA/DC	2,7-10V/DC	65x29x18mm
LSC3W	45H-LSC3W500LR-ZU	90-264V/AC	1,4-3,5W	500 mA/DC	2,7-7V/DC	65x29x18mm
LSC3W	45H-LSC3W700LR-ZU	90-264V/AC	1,9-2,8W	700 mA/DC	2,7-4V/DC	65x29x18mm



PHASE-CUT

CC6W	427-CC6W350TR	198-264V AC	4,55-7,35W	350 mA/DC	13-21 V/DC	38 x 30 x 20 mm
CC10W	427-CC10W500TR	198-264V AC	6,5-10W	500 mA/DC	13-20V/DC	58,2 x 36 x 20 mm

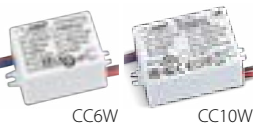

MP15 HPFU	448-127710	90-264V/AC	max. 2,5W bis max. 15W	60-360mA/DC	2-41,5V/DC	115x34x19mm
-----------	------------	------------	------------------------	-------------	------------	-------------

Ausgangstrom: 60-360mA/DC in 20mA Schritten per dipswitch einstellbar
 Output current: 60-360mA/DC adjustable in 20mA steps via dipswitch



LC8W fixC SR SNC2	3528003343	198-264V/AC	4,9-7,6W	180mA/DC	27-42V/DC	101,5x49x29mm
LC10W fixC SR SNC2	3528003344	198-264V/AC	6,8-10,5W	250mA/DC	27-42V/DC	101,5x49x29mm
LC7W fixC SR SNC2	3528003348	198-264V/AC	1,1-7W	350mA/DC	3-20V/DC	101,5x49x29mm
LC15W fixC SR SNC2	3528003345	198-264V/AC	9,5-14,7W	350mA/DC	27-42V/DC	101,5x49x29mm
LC21W fixC SR SNC2	3528003346	198-264V/AC	13,5-21W	500mA/DC	27-42V/DC	101,5x49x29mm



PHASE CUT

Mini Jolly 250-900 mA	448-125400	99-264V/AC	max. 18W	350 mA/DC	15-50V/DC	110,4x52x22 mm
			max. 20W	500 mA/DC	5-40V/DC	
			max. 20W	700 mA/DC	3-29V/DC	
			max. 20W	900 mA/DC	3-23V/DC	
			max. 10W		12V/DC	
			max. 20W		24V/DC	

1-10V PUSH DIM



CC CONVERTER

LCA 60W flexC SR ADV	3528002498	198-264V AC	30-56W	1050 mA/DC*	28,5-54V/DC	160x82x34 mm
			30-60W	1200 mA/DC	25-50V/DC	
			30-60W	1400 mA/DC	21,5-43V/DC	



PLUG
3528001771 | ADV Plug Type A

*Standardwert, kein Plug notwendig.
Default value, no plugin necessary.

zur Stromeinstellung
for current setting

LC 20W NF SR EXC3	3587500961	198-264V/AC 176-270V/DC	1,5-4,4W	100 mA/DC	15-44V/DC	120x51x29,2 mm
			2-11W	250 mA/DC	7-44V/DC	
			2,5-15W	350 mA/DC	7-44V/DC	
			3,5-18W	500 mA/DC	7-36V/DC	
			5-18W	700 mA/DC	7-25,8V/DC	
			6,3-18W	900 mA/DC	7-20V/DC	
7,5-18W	1050 mA/DC	7-17V/DC				



LC 27W NF SR EXC3	3587500962	198-264V/AC 176-270V/DC	2,7-5,4W	100 mA/DC	27-54V/DC	160x82x34 mm
			9,5-18,9W	350 mA/DC	27-54V/DC	
			13,5-27W	500 mA/DC	27-54V/DC	



LC 45W NF SR EXC3	3587500963	198-264V/AC 176-270V/DC	13,5-27W	500 mA/DC	27-54V/DC	160x82x34 mm
			18,9-37,8W	700 mA/DC	27-54V/DC	
			21,6-43,2W	800 mA/DC	27-54V/DC	
			28,5-45W	1050 mA/DC	27-42,9V/DC	

Stromeinstellung bei Bestellung angeben (zum Beispiel: 3587500963-0800MA)
Specify current setting when ordering (for Example: 3587500963-0800MA)

LCA 44W flexC PH-C SR ADV	3587500605	198-264V AC	20-30W	700 mA/DC	28-42V/DC	130x68x31 mm
			29,5-44W	1050 mA/DC	28-42V/DC	

PHASE CUT



CC CONVERTER

LC 20W o4a NF SR EXC3	3587500921	198-264V/AC 176-270V/DC	1,5-4,4W	100 mA/DC	15-44V/DC	120x51x29,2 mm
			2-11W	250 mA/DC	7-44V/DC	
			2,5-15W	350 mA/DC	7-44V/DC	
			3,5-18W	500 mA/DC	7-36V/DC	
			5-18W	700 mA/DC	7-25,8V/DC	
			6,3-18W	900 mA/DC	7-20V/DC	
7,5-18W	1050 mA/DC	7-17V/DC				

Stromeinstellung bei Bestellung angeben (zum Beispiel: 3587500921-0500MA)
Specify current setting when ordering (for Example: 3587500921-0500MA)



LC 27W o4a NF SR EXC3	3587500922	198-264V/AC 176-270V/DC	2,7-5,4W	100 mA/DC	27-54V/DC	160x82x34 mm
			9,5-18,9W	350 mA/DC	27-54V/DC	
			13,5-27W	500 mA/DC	27-54V/DC	

LC 45W o4a NF SR EXC3	3587500923	198-264V/AC 176-270V/DC	13,5-27W	500 mA/DC	27-54V/DC	160x82x34 mm
			18,9-37,8W	700 mA/DC	27-54V/DC	
			21,6-43,2W	800 mA/DC	27-54V/DC	
			28,5-45W	1050 mA/DC	27-42,9V/DC	

DALI SWITCH DIM

Stromeinstellung bei Bestellung angeben (zum Beispiel: 3587500923-0800MA)
Specify current setting when ordering (for Example: 3587500923-0800MA)



IPR2	448-152014/350	99-264V/AC 170-276V/DC	1-17W	350 mA/DC	5-49V/DC	121,5x53,5x26mm
IPR2	448-152014/500		1-24W	500 mA/DC	5-49V/DC	121,5x53,5x26mm
IPR2	448-152014/700		1-30W	700 mA/DC	5-43V/DC	121,5x53,5x26mm

IP68



IPR3 Flat 38 DALI NFC	448-152040	99-264V/AC	1,5-38W	150-1050 mA/DC	10-54V/DC	127x47x28mm
-----------------------	------------	------------	---------	----------------	-----------	-------------

IP68 DALI PUSH DIM



basicDIM Wireless - CASAMBI ready

LC 10W bdW SC PRE2 IP20	3528002411	198-264V/AC 176-270V/DC	2,25-10W	150-400 mA/DC	15-40V/DC	130x43x30mm
LC 17W bdW SC PRE2 IP20	3528002412		3,75-17W	250-700 mA/DC	15-50V/DC	130x43x30mm
LC 25W bdW SC PRE2 IP20	3528002413		7-25W	350-1050 mA/DC	20-50V/DC	130x43x30mm
LC 45W bdW SC PRE2 IP20	3528002414		12,5-45W	500-1400 mA/DC	25-50V/DC	150x43x30mm

Stromeinstellung über LEDset Widerstand
Current setting via LEDset resistor



CV- 24V CONVERTER

PMR24 24V	45A-LKV024-008RU	190-265V/AC	24V/DC	max. 8,4W	ø 53x19mm
-----------	-------------------------	-------------	--------	-----------	-----------



Slim 24V	45AA40SL243500B	100-265V/AC	24V/DC	max. 8,4W	114x22x19mm
----------	------------------------	-------------	--------	-----------	-------------



SHT-MTL	439-VLM040E-24-T	220-240V/AC	24V/DC	max. 40W	199x20x20mm
SHT-MTL	439-VLM060E-24-T	220-240V/AC	24V/DC	max. 60W	199x20x20mm
SHT-MTL	439-VLM100E-24-T	220-240V/AC	24V/DC	max. 100W	209x26x20mm



LPH-18 24V	440-LPH-18-24	180-264V/AC	24V/DC	max. 18W	140x30x22mm
LPV-35 24V	440-LPV-35-24	90-264V/AC	24V/DC	max. 35W	148x40x30mm
LPV-60 24V	440-LPV-60-24	90-264V/AC	24V/DC	max. 60W	163x43x32mm
LPV-100 24V	440-LPV-100-24	90-264V/AC	24V/DC	max. 100W	190x52x37mm



IP67

LC 24V SC SNC2	3587501054	198-264V/AC	24V/DC	max. 35W	142x43x30mm
LC 24V SC SNC2	3587501055	198-264V/AC	24V/DC	max. 60W	225x43x30mm
LC 24V SC SNC2	3587501056	198-264V/AC	24V/DC	max. 100W	295x43x30mm
LC 24V SC SNC2	3587501057	198-264V/AC	24V/DC	max. 200W	325x43x30mm



ELG-75	440-ELG-75-24DA	100-305V/AC 142-431V/DC	24V/DC	max. 75W	180x63x35,5mm
ELG-150	440-ELG-150-24DA	100-305V/AC 142-431V/DC	24V/DC	max. 150W	219x63x35,5mm
ELG-240	440-ELG-240-24DA	100-305V/AC 142-431V/DC	24V/DC	max. 240W	244x71x35,5mm

DALI IP67

ELG-75

ELG-250

ELG-240



CV- 24V CONVERTER

OPTOTRONIC OT LED IP66 24V	540OT060P	198-264V/AC 176-250V/DC	24V/DC	max. 60W	205x43x26mm	
OPTOTRONIC OT LED IP67 24V	540OT130P	198-264V/AC 176-250V/DC	24V/DC	max. 130W	220x63x37mm	
OPTOTRONIC OT LED IP67 24V	540OT250P	198-264V/AC 176-250V/DC	24V/DC	max. 250W	265x68x40mm	

IP66 IP67



OPTOTRONIC OT LED IP66 24V	540OT060P-AN	198-264V/AC 176-250V/DC	24V/DC	max. 60W	205x43x26mm	
OPTOTRONIC OT LED IP67 24V	540OT130P-AN	198-264V/AC 176-250V/DC	24V/DC	max. 130W	220x63x37mm	
OPTOTRONIC OT LED IP67 24V	540OT250P-AN	198-264V/AC 176-250V/DC	24V/DC	max. 250W	265x68x40mm	

1-10V IP66 IP67

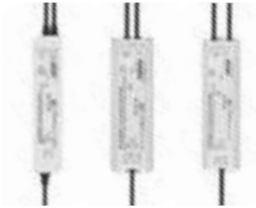

DC 45W MD 24V	448-127913	220-240V/AC	24V/DC	max. 45W	180x60x35mm
---------------	-------------------	-------------	--------	----------	-------------

PHASE CUT



DC 80W MD 24V	448-127915	220-240V/AC	24V/DC	max. 80W	200x70x46mm
---------------	-------------------	-------------	--------	----------	-------------

PHASE CUT IP66



LCA one4all SC PRE24V	3528001662	198-264V/AC 176-280V/DC	24V/DC	max. 35W	195x43x32,2mm
LCA one4all SC PRE24V	3528001663	198-264V/AC 176-280V/DC	24V/DC	max. 60W	225x43x32,2mm
LCA one4all SC PRE24V	3528001253	198-264V/AC 176-280V/DC	24V/DC	max. 100W	295x43x29,8mm
LCA one4all SC PRE24V	3528001437	198-264V/AC 176-280V/DC	24V/DC	max. 150W	325x43x29,8mm

DALI SWITCH DIM

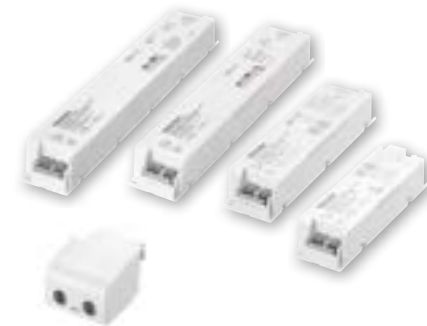

CV- 24V CONVERTER

basicDIM Wireless - CASAMBI ready

LC 35W bdW SC PRE2 IP20	3528002677
LC 60W bdW SC PRE2 IP20	3528002674
LC 100W bdW SC PRE2 IP20	3528002675
LC 150W bdW SC PRE2 IP20	3528002678

198-264V/AC
176-270V/DC

24V/DC	max. 35W	195x43x30,2 mm
24V/DC	max. 60W	225x43x30,2 mm
24V/DC	max. 100W	295x43x29,8 mm
24V/DC	max. 150W	325x43x29,8 mm



matter

LC 35W MTR SC PRE2 IP20	3528004489
LC 60W MTR SC PRE2 IP20	3528004490
LC 100W MTR SC PRE2 IP20	3528004491
LC 150W MTR SC PRE2 IP20	3528004492

198-264V/AC
176-280V/DC

24V/DC	max. 35W	195x43x30,2 mm
24V/DC	max. 60W	225x43x30,2 mm
24V/DC	max. 100W	295x43x29,8 mm
24V/DC	max. 150W	325x43x29,8 mm



CV - 48V CONVERTER

LT100/48	433-LTP-1025-V01	198-264V/AC 179-264V/DC	48V/DC	max. 100W	355x30x21 mm
----------	-------------------------	----------------------------	--------	-----------	--------------



LPV-60	440-LPV-60-48	90-264V/AC 127-370V/DC	48V/DC	max. 60W	163x43x32mm
--------	----------------------	---------------------------	--------	----------	-------------

IP67



LCA one4all NF SC EXC48V	3528003533	198-264V/AC 176-280V/DC	48V/DC	max. 35W	195x43x30mm
LCA one4all NF SC EXC48V	3528003534		48V/DC	max. 60W	195x43x30mm
LCA one4all NF SC EXC48V	3528003535		48V/DC	max. 100W	225x43x30mm
LCA one4all NF SC EXC48V	3528003536		48V/DC	max. 200W	325x43x30mm

DALI



ELG 48V DALI IP67	440-ELG-100-48DA	100-305V/AC 142-431V/DC	48V/DC	max. 100W	199x63x35,5mm
ELG 48V DALI IP67	440-ELG-240-48DA		48V/DC	max. 240W	244x71x35,5mm

IP67 DALI



LIGHT MEETS SUSTAINABILITY | PURE 1 & 2 SANIERUNGSKITS



Nachhaltigkeit wird bei PLANLICHT großgeschrieben. So wurde für die **Profilleuchten pure 1 & 2 (direkt strahlend)**, die in der Vergangenheit in vielen Projekten bestückt mit konventionellen Leuchtstofflampen zum Einsatz gekommen sind und mittlerweile durch die nächste Generation – pure 3 – abgelöst wurden, **LED-Sanierungskits** entwickelt.

Durch den Austausch mit dem LED-Retrofit-Leuchteneinsatz samt Durchgangsverdrahtung und LED-Diffusor erfahren die Leuchten in jeder Hinsicht ein Upgrade: erhöhte Lebensdauer, optimierter Sehkomfort, steigende Energieeffizienz und sinkende Energiekosten.

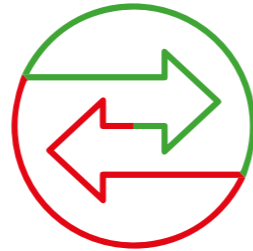

VORTEILE DURCH DAS UPGRADE AUF LED

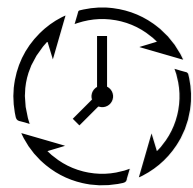

Erhöhte Lebensdauer

Zusätzliche Anwendbarkeit der PLANLICHT-Garantie 66 auf die LED-Träger



Sinkende Energiekosten

Stromkostensparnis



Optimierter Sehkomfort & verbessertes, homogenes Lichtbild



Neueste Technologie

- Umrüstung von Röhren-Leuchten auf LED für pure 1 & 2 in allen Montagearten
- Neue One-click Coex-Abdeckung



Steigende Energie-Effizienz

- Erzeugung von gleich viel Licht bei halber Leistungsaufnahme
- Vielfältig förderbar (Energie-Effizienz > 120 Lumen/Watt)



Wiederverwendung

- Weiterverwendung des Profils und der Einspeisklemme mit Zugentlastung & Erdung
- Bestands-Blindabdeckung ist bei linearen Varianten wiederverwendbar

DIE LÖSUNG VON PLANLICHT	Reduktion der Leistungsaufnahme (W)*	Effizienzsteigerung (lm/W)*	Stromkosten-Ersparnis (pro Laufmeter)**
pure 2 Sanierungskit high efficiency (FH/HE --> Upgrade auf LED LO)	43-51 %	65-109 %	49 %
pure 2 Sanierungskit high output (FQ/HO --> Upgrade auf LED HO)	39-55 %	85-146 %	55 %

Große Effizienz (FH = „Fluorescent High Efficiency“/HE = „High Efficiency“), hohe Lichtleistung (FQ = „Fluorescent Quintron“/HO = „High Output“)

* Abhängig von Abdeckung/Optik

**Berechnung basierend auf dem Upgrade einer pure 2 mit einer 1.149mm langen Röhre auf LED (jeweils mit satinierem Diffusor)

IN DREI SCHRITTEN ZUM LEUCHTEN-UPGRADE

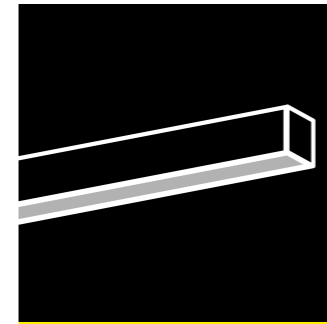

1. BESTANDSAUFNAHME

Stellen Sie die Informationen zur bestehenden Leuchte zusammen:

- Montageart
- Diffusor/Optik (satiné, mikroprismatisch)
- Leuchtstoffröhren-Type (FQ/FH)
- Länge der Bestandsleuchte



2. KONTAKTAUFNAHME & ANGEBOT

Nehmen Sie Kontakt mit PLANLICHT auf und stellen Sie alle Informationen zu Ihrer Bestandsleuchte bereit.

PLANLICHT erstellt in der Folge ein Angebot für das für Ihre Bestandsleuchte passende Sanierungskit.

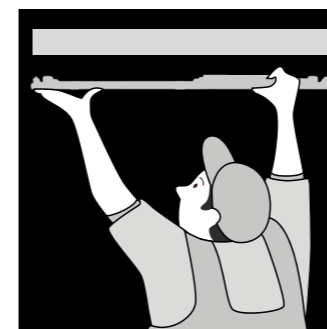

3. DEMONTAGE BZW. MONTAGE DES KITS

Nach der Bestellung und Lieferung des Sanierungskits kann die Demontage bzw. Montage erfolgen.

VERANSCHAULICHUNG PURE 2

- bestehender Lichteinsatz für Leuchtstoffröhre mit elektronischem Vorschaltgerät und Durchgangsverdrahtung wird entfernt

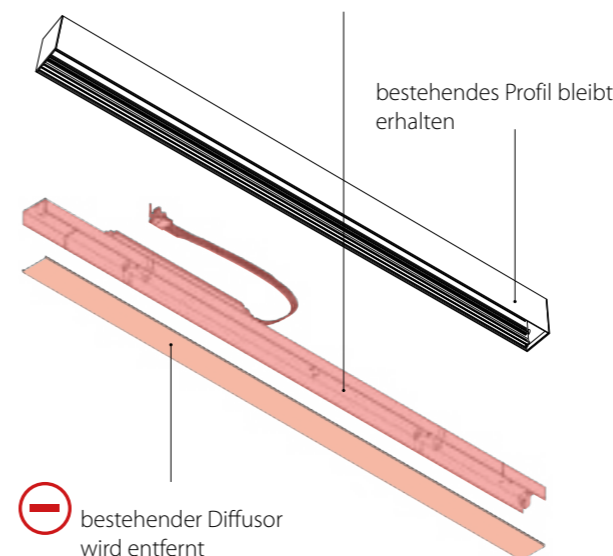

- bestehender Diffusor wird entfernt

bestehendes Profil bleibt erhalten

+ neuer Lichteinsatz für die Umrüstung (inklusive LED-Band, elektronischem Vorschaltgerät und Durchgangsverdrahtung) wird mit Hilfe des Halteblechs im Profil eingeklemmt

+ neue Coex-pure 2-Abdeckung wird mit einem Klick montiert

LIGHT MEETS SUSTAINABILITY | PURE 1 & 2 REFURBISHMENT KITS



Sustainability is a top priority at PLANLICHT. An LED refurbishment kit has been developed for the pure 1 & 2 profile luminaires (direct), which have been used in many projects in the past with conventional fluorescent lamps and have been replaced by the next generation - pure 3.

By replacing it with the LED retrofit luminaire insert including through-wiring and LED diffuser, pure 1 & 2 undergo an upgrade in every respect: increased service life, optimised visual comfort, rising energy efficiency and falling energy costs.

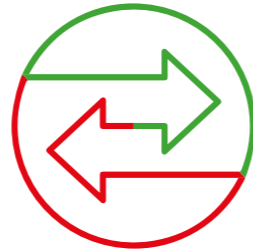

ADVANTAGES OF UPGRADING TO LED

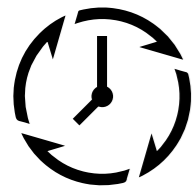

Increased service life

Additional applicability of the PLANLICHT guarantee 66 to the LED supports



Decreasing energy costs

Electricity cost savings



Optimised visual comfort & improved, homogeneous light pattern



Latest technology

- Conversion from tubular luminaires to LED for pure 1 & 2 in all mounting types
- New one-click Coex cover



Increased energy efficiency

- Generation of the same amount of light with half the power consumption
- Various subsidies available (energy efficiency > 120 lumens/watt)



Reuse

- Reuse of the profile as well as the feed-in terminal with strain relief and earthing
- Existing blind cover can be reused with linear versions

OUR SOLUTION	Reduction of power consumption (W)*	Efficiency increase (lm/W)*	Electricity cost savings (per metre)**
pure 2 Refurbishment Kit high efficiency (FH/HE --> upgrade to LED LO)	43-51 %	65-109 %	49 %
pure 2 Refurbishment Kit high output (FQ/HO --> upgrade to LED HO)	39-55 %	85-146 %	55 %

FH = „Fluorescent High Efficiency“/HE = „High Efficiency“, FQ = „Fluorescent Quintron“/HO = „High Output“

* Depending on cover/optics

** Calculation based on the upgrade of a pure 2 profile luminaire with a 1,149mm long tube to LED (each with satiné diffuser)

UPGRADE YOUR LUMINAIRES IN THREE STEPS

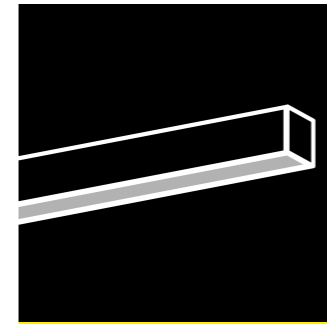

1. INVENTORY

Compile the information on the existing luminaire:

- Mounting type
- Diffuser/optics (satiné, microprismatic)
- Fluorescent tube type (FQ/FH)
- Length of existing luminaire



2. CONTACT & OFFER

Contact PLANLICHT and provide all information about your existing luminaire.

PLANLICHT will then prepare a quotation for the appropriate refurbishment kit for your existing luminaire.

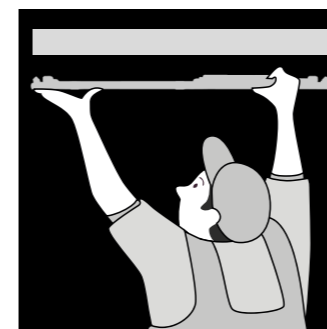

3. DISASSEMBLY OR ASSEMBLY OF THE KIT

Once the refurbishment kit has been ordered and delivered, it can be dismantled or installed.

Visualization of PURE 2

- existing light insert for fluorescent tube with electronic ballast and through-wiring is removed

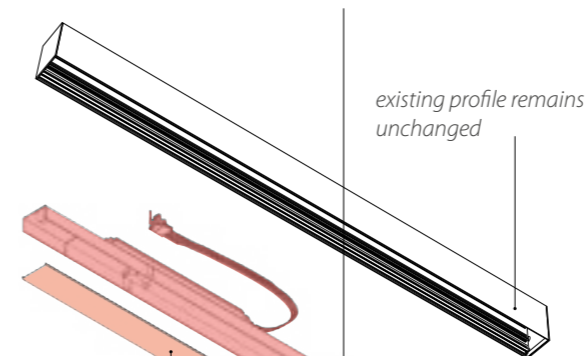

- existing diffuser is removed

existing profile remains unchanged

+ new light insert for conversion, including LED strip, electronic ballast and through-wiring is clamped into the profile using the retaining plate

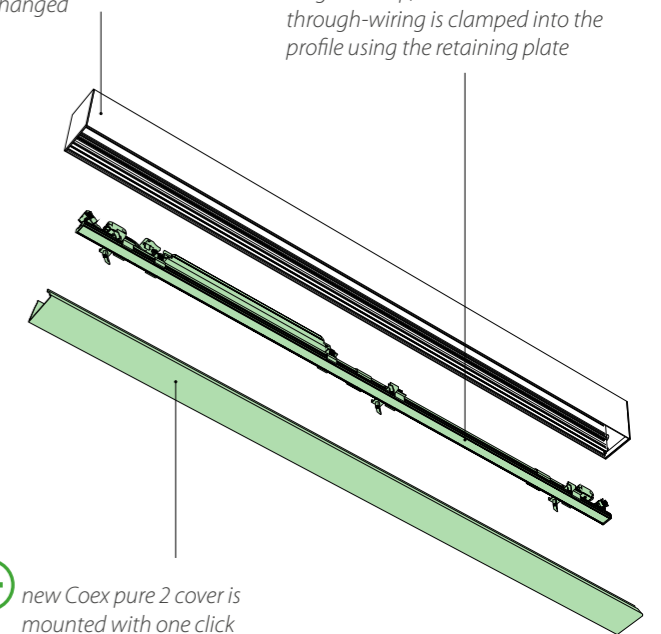

+ new Coex pure 2 cover is mounted with one click



felt

Akustikpaneel
Acoustic panel
Panneau acoustique

FELT



suspended round





wall mounted (magnetic)
rectangle 604 x 1204 mm



wall mounted (magnetic)
square 604 x 604 mm



1 TYPE

-  Suspended Rectangle / Square
-  Suspended Round
-  Wall Mounted Rectangle / Square

2 SIZE

- HE** 604x604 mm
- HR** 604x1204 mm
- WE** Ø700 mm
- Ø900 mm
- Ø1200 mm

3 MATERIAL

-  QUIET.FELT standard anthracite melange **QA**
-  QUIET.FELT extra+ light grey melange **QG**
-  QUIET.FELT standard lime **QL**

- 06Q**
- 120**
- 070**
- 090**
- 120**

643-1-2-3

643-WE120-QA 600x1200 mm, anthracite melange acoustic module (order sample)

► Configure online on KATALOG.PLANLICHT.COM



EQUIVALENT SOUND ABSORPTION AREA / ABSORBER QUIET.FELT

A_{eq}

Frequency Hz	100	125	160	200	250	315	400	500	630	800	1000	1250	1600	2000	2500	3150	4000	5000
600x600mm	0,16	0,24	0,40	0,64	0,74	0,83	0,94	1,02	1,08	1,09	1,07	1,08	1,04	1,02	1,00	1,01	1,02	1,03
600x1200mm	0,15	0,26	0,41	0,63	0,75	0,84	0,95	1,03	1,09	1,10	1,08	1,08	1,05	1,02	1,00	1,02	1,03	1,03
Ø 900mm	0,03	0,07	0,25	0,37	0,42	0,52	0,53	0,69	0,81	0,89	1,06	1,1	1,2	1,21	1,26	1,25	1,23	1,22

RECOMMENDED NUMBER OF PANELS

panel 600x1200 mm	2x	4x	6x	8x	12x	15x
panel 600x600 mm	4x	8x	12x	16x	24x	30x
Ø 700mm	4x	8x	12x	16x	24x	30x
Ø 900 mm	2-3x	4-5x	6-7x	9x	13-14x	17x
Ø 1200 mm	1-2x	2-3x	4x	5-6x	8x	10x
small rooms < 15 m ²	noticeable	good	very good	excellent		
medium rooms < 20 m ²		noticeable	good	very good	excellent	
large rooms < 35 m ²		noticeable	noticeable	good	very good	excellent

ACOUSTIC PANEL

ISO 11654: Class A, $\alpha_w = 1,00$
EN 13501-1: B-s2,d0

For exact planning contact your local acoustic physicist.

3 MATERIAL OPTIONS



available as stand-alone panel and for SINUS.QUIET and QUADRO.QUIET

available for SINUS.QUIET and QUADRO.QUIET on request



Farbkarten <i>Color charts Nuanciers (Cartes de couleurs)</i>	458
Technische Informationen <i>Technical information Informations techniques</i>	463
Katalog Informationen zur Nutzung <i>Catalogue usage Informations d'utilisation du catalogue</i>	464
Allgemeine Geschäfts- & Lieferbedingungen <i>General terms and conditions Conditions générales de vente</i>	466
Garantiebestimmungen "Garantie 66" <i>Warranty terms Modalités de garantie</i>	472
Artikelnummern Die Logik hinter dem Code <i>Item numbers Numéros d'article</i>	475
Piktogramme (Legende) <i>Pictograms Pictogrammes</i>	476

FARBKARTEN | GEHÄUSE & KABEL

COLOR CHARTS | HOUSING & CABLES

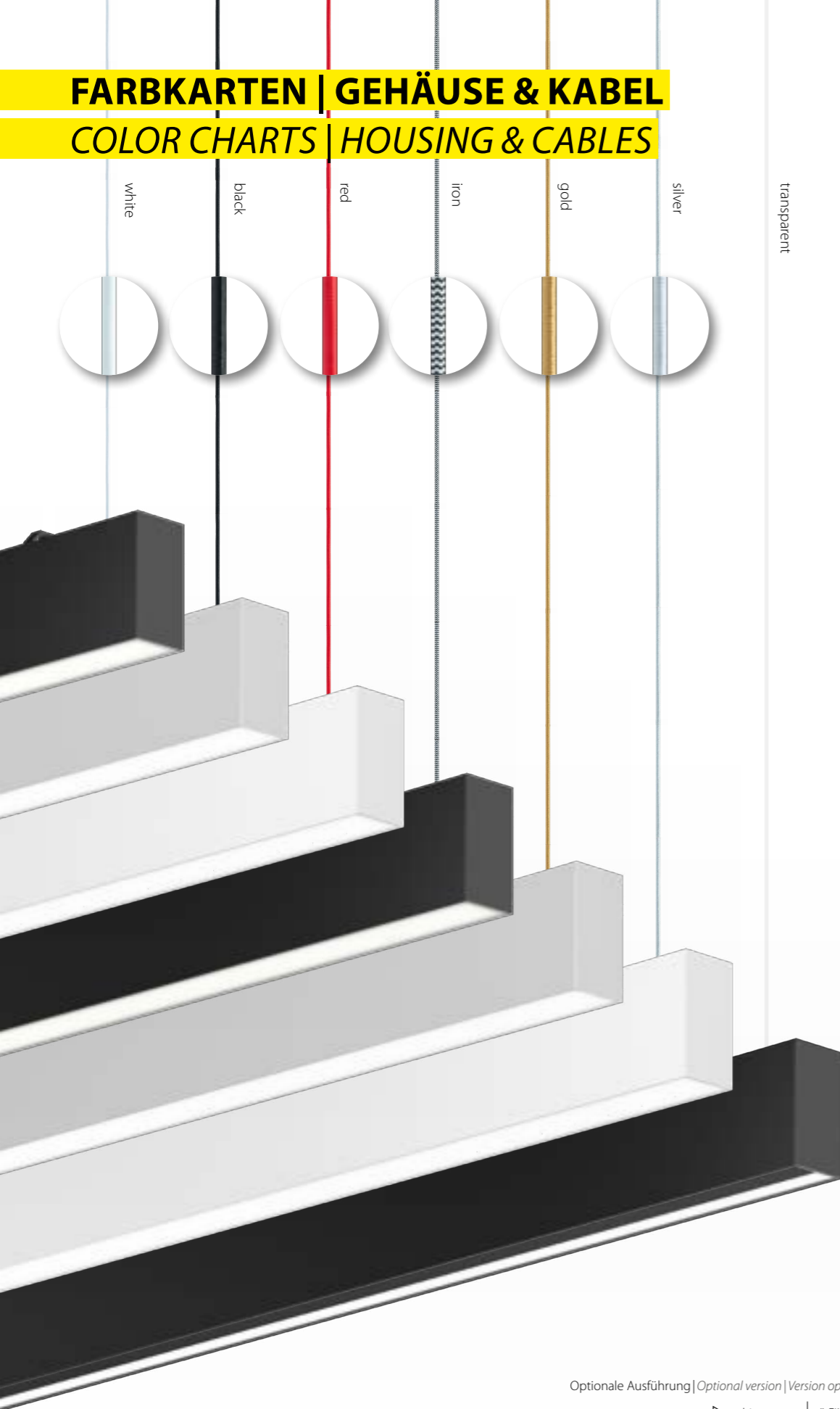

Optionale Ausführung | Optional version | Version optionnelle

▷ white	*-EIN-WHITE
▷ black	*-EIN-BLACK
▷ red	*-EIN-RED
▷ iron	*-EIN-IRON
▷ gold	*-EIN-GOLD
▷ silver	*-EIN-SILVER

1750mm
5x0,75mm²

Transparentes Kabel inkl. (Standard Version)

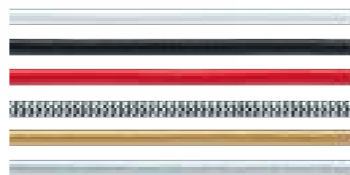

für besondere Anfragen

RAL NACH WAHL | OPTIONALE GEHÄUSEFARBEN

RAL OF YOUR CHOICE | OPTIONAL HOUSING COLOURS



FARBKARTEN | RASTER, MASKEN & TUBI

COLOUR CHARTS | LOUVRES, MASKS & TUBES



white 9019 black 9005 glaring gold high-gloss black chrome high-gloss gold gunnery grey high-gloss copper capital copper silver matte high-gloss silver



FARBKARTEN | DIFFUSOREN & OPTIKEN

COLOUR CHARTS | DIFFUSERS & OPTICS

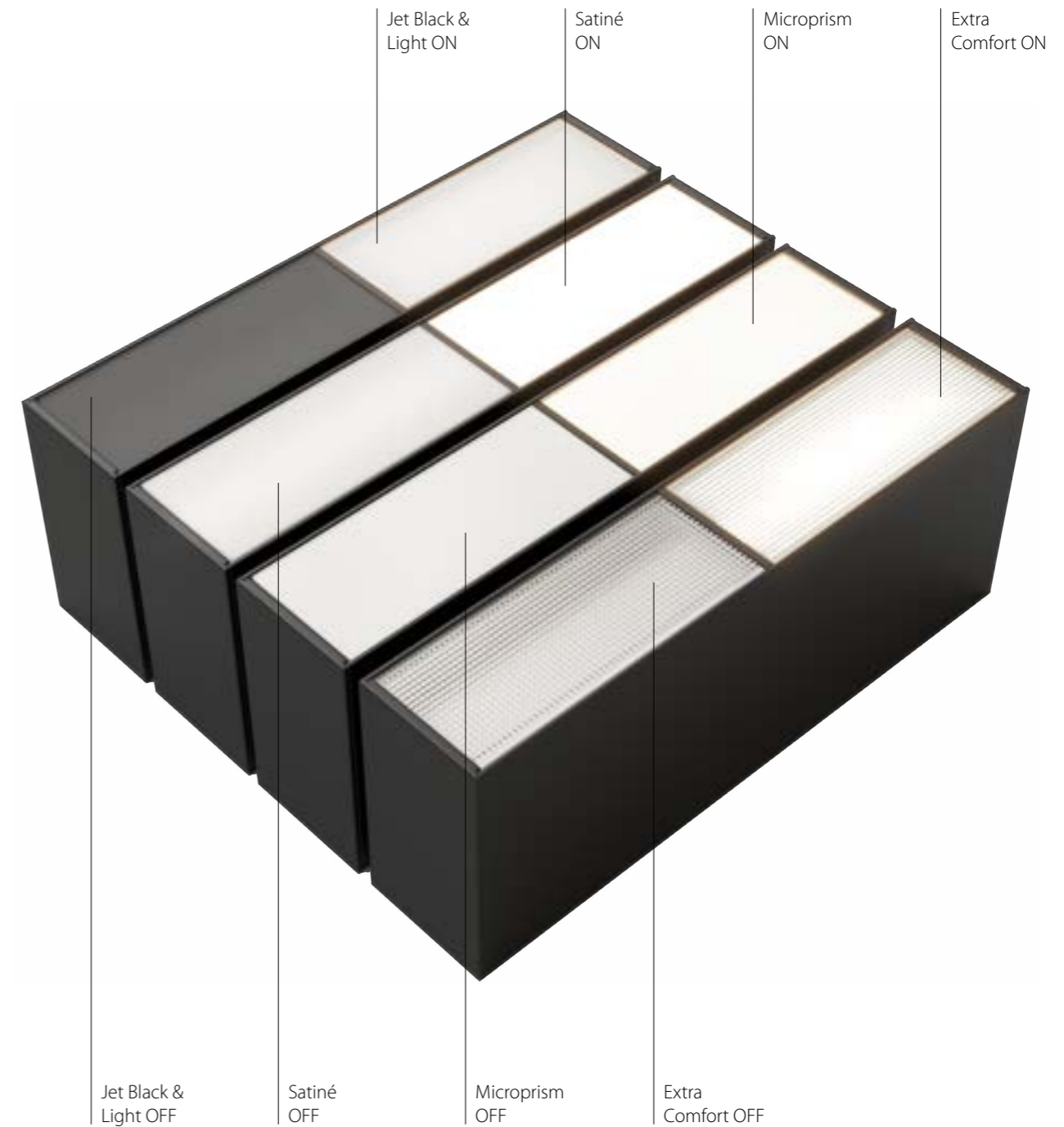

ORGANOID®



WILDSPITZE
[vɪltʃpɪtsə]



WOLLÄ
[ˈvɔlə]

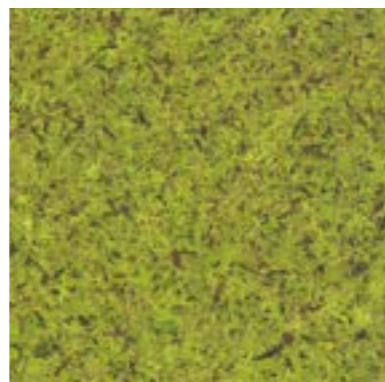

MOUS
[ˈmøʊz]

FELT.QUIET

STANDARD



ANTHRACITE MELANGE



LIME



PEBBLE | KIESEL

EXTRA +



BLACK



FIRE



CHOCOLATE



LIGHT GREY MELANGE

Leistung, Lichtstrom und Farbtemperatur unterliegen durch den Einsatz von elektronischen Bauteilen produktionsbedingten Toleranzen. Toleranzen Leistung und Lichtstrom: +/- 10 %. Toleranz Farbtemperatur: +/- 150 K. Lichtstrom dynamisch weiss bei 2700 K.

Bestromung und Temperatur

LEDs unterliegen während ihrer Lebensdauer Veränderungen in den Eigenschaften. Die Bestromung der LED und das Temperaturmanagement nehmen dabei vorrangig Einfluss. Zunehmend mit der Betriebstemperatur der LED verstärken sich über die Nutzungsdauer Verschiebungen des Farborts und Abnahme des Lichtstroms. Um die Veränderung zu minimieren, werden die Produkte in diesem Katalog daher meist mit weniger Strom betrieben als vom Hersteller empfohlen. In Verbindung mit ausgereiftem Thermomanagement können wir damit eine niedrige Betriebstemperatur unserer LEDs sicherstellen, was eine nachhaltige geringere Farbortverschiebung und minimierte Lichtstromabnahme zur Folge hat.

Farbortverschiebung

Während der Einbrennphase in den ersten 1.000 Betriebsstunden unterliegen LEDs einer Farbortverschiebung einer 2-Step-MacAdam-Ellipse. Mit niedrigem Betriebsstrom erhöht sich die Farbortverschiebung nach diesem Zeitraum über die Lebensdauer unserer LEDs ausgehend vom gelieferten Binning-Feld nur geringfügig. Die gesamte Farbortverschiebung bleibt somit in der Regel innerhalb einer 3-Step-MacAdam Ellipse.

Lichtstromabnahme

LEDs verlieren über die Zeit an Lichtstrom. Diese Lichtstromdegradation lässt sich über verschiedene Werte messen: L-Wert, B-Wert und Betriebsdauer in Stunden. Der L-Wert gibt den Prozentsatz des Anfangslichtstroms bei Erreichen der Betriebsdauer in Stunden an. Der B-Wert sagt aus, wie viel Prozent der LED den L-Wert unterschreiten dürfen. Ist kein B-Wert angegeben, so gilt der Wert B50. Beispielfähig würde das bei der Angabe 40.000h L80/B50 bedeuten, dass nach einer Betriebsdauer von 40.000h der Ausgangslichtstrom auf 80% gesunken ist und mindestens 50% der LEDs diesen Wert nicht unterschreiten. Da die tatsächlich erreichte Lebensdauer von verschiedenen Faktoren wie der Umgebungstemperatur, Luftfeuchtigkeit und der eingestellten Bestromung (LO, HO, usw.) abhängt, werden in diesem Katalog nur Richtwerte für den jeweiligen

Leuchtentyp angegeben. Auf Anfrage kann die Lebensdauer für einen expliziten Leuchtentyp unter Angabe der zu erwartenden Randbedingungen weiter eingegrenzt werden. Bei den hier aufgeführten Leuchten mit einem Indirektanteil sind die Direkt- und die Indirektseite standardmäßig nicht getrennt schaltbar (Artikelnummer-Bereich Output: 1, non-dim) beziehungsweise nicht getrennt schalt- und dimmbar

(Artikelnummer-Bereich Output: 3, DALI dim) ausgeführt. Die mit „DALI switchDIM“ gekennzeichneten Leuchten sind sowohl über DALI, als auch unter Verwendung einer Neutralleiterbrücke mit switch-Dim ansteuerbar. Falls eine getrennte Schalt- oder Dimmbarkeit gewünscht ist, existieren in Abhängigkeit von der gewünschten Steuerart verschiedene vordefinierte Sonderausführungen.

Bei Interesse wenden Sie sich bitte an unser Kundenservicecenter.

TECHNICAL INFORMATION

The power output, luminous flux and colour temperature can be slightly different due to specific electronic components used in the manufacturing process. The power output and luminous flux can differ by +/- 10%. The colour temperature can differ by +/- 150 K. Luminous flux dynamic white at 2700 K.

Current feed and temperature

LEDs are subject of changes during their lifespan. Current feed and thermal management take major influence. As LED operating temperatures increase, the colour locations shift more heavily and the luminous flux decreases over the LED's lifespan.

To minimize changes the products in this catalogue are operated with less current than recommended by the manufacturer. Combined with advanced thermal management a lower operating temperature of our LEDs can be ensured which leads to lower levels of colour location shifts and luminous flux degradation over the long term.

Colour point shift

During the burn-in-phase of the first 1'000 hours of operation LEDs are subject to a colour point shift of one 2-step MacAdam ellipse. Due to lower operating current the colour point shift increases slightly after the burn-in-phase during the lifespan of the LEDs based on the binning group at delivery. So the total colour point shift generally remains within one 3-step MacAdam ellipse.

Luminous flux degradation

Over time the LEDs' luminous flux declines. This degradation of the luminous flux is measured by different values: L-value, B-value and time of operation in hours. The L-value represents the percentage of the luminous flux of the initial luminous flux when the time of operation is reached. The B-value shows the percentage of the LEDs whose luminous flux might be below the L-value upon reaching the time of operation. B50 applies to all products without specified B-value. For example: 40,000h L80/B50 means that at a usage of 40,000 hours we would expect a maximum of 50% (B50) of the LEDs are under 80% (L80) of their starting lux value (either by dimming, failing or a combination thereof). The estimated lifetime is defined under controlled conditions and will vary according to actual ambient temperature, humidity and the power output of the LED (LO, HO, etc.). Upon request we can estimate a more accurate luminaire lifetime when provided with information pertaining to the environmental conditions of the installation area.

The case of direct/indirect luminaires with a "1" (non-dim) in the "Dimming Type" segment of the article number (#9), the direct and indirect sides cannot be separately switched as standard, with a "3" (DALI-dim) in the "Dimming Type" segment of the article number the direct and indirect sides are not separately switchable and dimmable. The luminaires marked with "DALI-switchDIM" can be controlled via DALI as well as switchDIM using a neutral conductor bridge. If separate switching or dimming is desired, then there are several predefined special versions depending on the desired control type.

If interested, please contact our Customer Service Center.

INFORMATIONS TECHNIQUES

La puissance, le flux lumineux et la température de couleur peuvent légèrement différer en raison de l'utilisation de composants électroniques spécifiques dans le processus de production. La puissance et le flux lumineux peuvent différer de +/- 10%. La température de couleur peut différer de +/- 150 K. Flux lumineux blanc dynamique à 2700 K.

Alimentation et température

Les caractéristiques des LED peuvent changer au cours de leur durée de vie. L'alimentation des LED et la gestion thermique ont une influence considérable sur ces changements. Plus la température de la LED en fonctionnement est élevée, plus les risques de déviation chromatique et de perte de flux lumineux augmentent au cours de la durée d'utilisation. Pour minimiser ces changements, les produits du présent catalogue sont pour la plupart alimentés avec un courant d'intensité plus faible que celui recommandé par le fabricant. Grâce à des analyses approfondies sur la gestion thermique, nous pouvons garantir que la faible température de nos LED en fonctionnement réduit fortement les risques de déviation chromatique et de perte de flux au cours de la durée de vie du produit.

Variation chromatique

Lors de la phase de rodage, pendant les 1 000 premières heures de fonctionnement, les LED ont une variation chromatique de rang 2 sur l'ellipse de MacAdam. Après cette phase et pendant toute la durée de vie de nos LED, les coordonnées chromatiques ne diffèrent que légèrement par rapport au groupe de binning livré, grâce à la faible intensité du courant d'alimentation. La variation chromatique reste donc généralement comprise à l'intérieur du rang 3 de l'ellipse de MacAdam.

Perte de flux lumineux

Le flux lumineux des LED peut baisser au cours du temps. Il existe plusieurs indicateurs pour mesurer la dégradation du flux lumineux : valeur L, valeur B et durée de fonctionnement en heures. La valeur L correspond au pourcentage du flux lumineux initial quand la durée de fonctionnement en heures est atteinte. La valeur B indique le pourcentage de LED pouvant présenter un flux lumineux inférieur à la valeur L. Si la valeur B n'est pas indiquée, sa valeur par défaut est B50. Par exemple, l'indication « 40 000h L80/B50 » signifie que le flux lumineux sortant représente minimum 80 % du flux sortant initial après une durée d'utilisation de 40 000 heures et que minimum 50 % des LED conservent un flux supérieur ou égal à cette valeur. Comme la durée de vie réelle dépend de différents facteurs, comme la température ambiante, l'humidité de l'air et le courant d'alimentation (LO, HO, etc.), les valeurs indiquées dans le présent catalogue sont uniquement des valeurs indicatives pour les différents types de luminaires. Sur demande, la durée de vie d'un type de luminaire particulier peut être déterminée plus précisément, sous réserve de la transmission d'informations sur les conditions du site d'installation.

Les luminaires en éclairage direct/indirect présentés ici ne permettent pas, de manière standard, un allumage séparé des côtés direct et indirect (luminaires non gradables ou « nondim » avec le chiffre « 1 » en position « Output » du numéro d'article), ni un allumage et une gradation séparées des côtés direct et indirect (luminaires gradables DALI ou « DALI dim » avec le chiffre « 3 » en position « Output » du numéro d'article). Les luminaires avec la mention « DALI switchDIM » permettent d'utiliser soit une gestion DALI, soit une gestion switchDIM en installant un pont sur le conducteur neutre. Si vous souhaitez une version avec un allumage ou une gradation séparée, nous vous proposons des solutions sur-mesure en fonction du type de gestion désiré.

Pour toute demande, veuillez contacter notre service clients.



QR-CODES

In dieser Broschüre finden Sie zahlreiche QR-Codes. Sie sind an weiteren Informationen zum Thema interessiert? Dann scannen Sie dementsprechenden Code ganz einfach mit Ihrem Smartphone.

In this brochure, you will find numerous QR codes. Are you interested in further information on the topic? Then simply scan the corresponding code with your smartphone.



Verfügbare Standardkonfiguration, Details zur Artikelnummernlogik finden sie hinten im Katalog. Keine passende Produktvariante gefunden? Treten Sie bitte mit uns in Kontakt!

Available standard configuration, details of the logic behind the item numbers you will find at the end of the catalogue. Unable to find a suitable product version? Then simply get in touch with us!

Neben den Basics an technischen Daten finden Sie alle relevanten Daten, wie Ausschreibungstexte mit und ohne Leitfabrikat, EPREL, Anzahl DALI-Adressen, Info Stk./%-Auslastung je Leistungsschutzautomat, Montage- und Demontageanleitungen u.v.m. zu Standardartikeln und Artikel-Konfigurationen im Online-Webkatalog.

In addition to the basic technical specifications, you will find all relevant data, such as tender texts with and without a leading product, EPREL, number of DALI addresses, info on pieces/% utilisation per circuit breaker, mounting and disassembly instructions and much more for standard items and item configurations in the online web catalogue.

Exemplarischer Artikel - benötigen Sie Hilfe, kontaktieren Sie uns bitte!

Illustrative item - if you need help, please contact us!

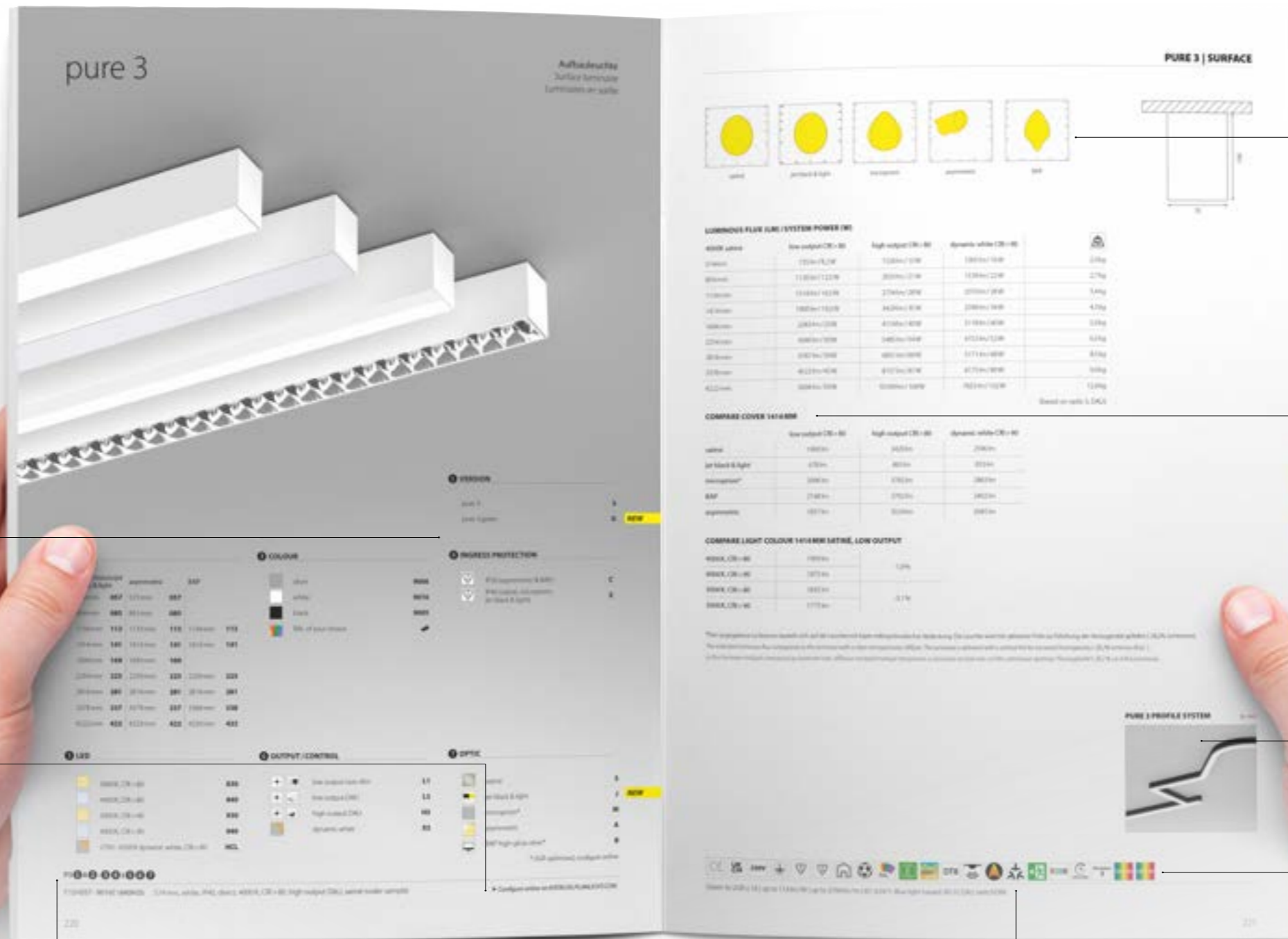

KATALOG | INFORMATIONEN ZUR NUTZUNG
INFORMATION ON USE | INFORMATIONS SUR L'UTILISATION

Lichtverteilungsgraphen je Lichtlenkung, Eulumdats finden Sie im Online-Webkatalog je Artikel, als Familien-Zip oder via DIALux Plugin/Leuchtenkatalog! Direkt/indirekt-Leuchten sind standardmäßig immer ein Schalt- bzw. Dimmkreis, kontaktieren Sie uns gerne bei individuellen Anforderungen.

Light distribution graphs for each light control, EULUMDATs for each item can be found in the online web catalogue, as a family zip or via DIALux plugin/luminaire catalogue. Direct/indirect luminaires always have a switching/dimming circuit as standard, please get in touch with us to discuss individual requirements.

Überblicks-Matrix je Lichtlenkung bzw. Lichtoptik in einer exemplarischen Farbtemperatur bzw. Leuchtenlänge, alle Artikel unterliegen einer kontinuierlichen technischen Verbesserung, exakte Angaben je Artikelausprägung finden Sie im Online-Webkatalog bzw. auf PLANLICHT-Verkaufsbelegen und Datenblättern. Leistung, Lichtstrom und Farbtemperatur unterliegen durch den Einsatz von elektronischen Bauteilen produktionsbedingten Toleranzen. Toleranzen Leistung und Lichtstrom: +/- 10%. Toleranz Farbtemperatur: +/- 150K. Lichtstrom dynamisch weiss bei 2700K.

Overview matrix for each light control or light optic in an illustrative colour temperature or luminaire length, all items are subject to continuous technical improvement, exact details for each item feature can be found in the online web catalogue or in PLANLICHT sales documents and data sheets. The power output, luminous flux and colour temperature can be slightly different due to specific electronic components used in the manufacturing process. The power output and luminous flux can differ by +/- 10%. The colour temperature can differ by +/- 150 K. Luminous flux dynamic white at 2700K.

Seitenverweis auf Leuchtenfamilie, Zubehör oder Systemkomponenten
Page reference to luminaire family, accessories or system components

Piktogrammleiste, angeführte Ausprägungen betreffen zumindest einen aber nicht zwingend alle Artikel der jeweiligen Leuchtenfamilie, Picto-Legende finden sie hinten im Katalog.

Pictogram bar, listed features relate to at least one but not necessarily all items of the respective luminaire family, pictogram key you will find at the end of the catalogue.

Technische Kennzahlen, angeführte Werte betreffen zumindest einen aber nicht zwingend alle Artikel der jeweiligen Leuchtenfamilie, exakte Angaben je Artikel finden Sie im Online-Webkatalog bzw. in PLANLICHT-Verkaufsbelegen und Datenblättern.

Key technical specifications, listed values relate to at least one but not necessarily all items of the respective luminaire family, exact details for each item can be found in the online web catalogue or in PLANLICHT sales documents and data sheets.

GARANTIEBESTIMMUNGEN | "GARANTIE 66"

Die planlicht GmbH & Co KG, Au 25, A-6134 Vomp, gewährt durch ihre jeweiligen Vertriebsniederlassungen folgende Herstellergarantie von 66 Monaten auf

PLANLICHT-Produkte:

Wir garantieren gemäß den nachfolgend näher bezeichneten Bedingungen, dass unter der Marke „PLANLICHT“ vertriebene Produkte bei bestimmungsgemäßem Gebrauch während eines Garantiezeitraums von 66 Monaten (5 ½ Jahre) ab Rechnungsdatum frei von Fabrikations- und/oder Materialfehlern sind.

1. Vorgeführt wird, dass soweit im Folgenden von Kunde gesprochen wird, der Begriff „Kunde“ als gewerblicher Händler bzw. Vertragspartner des Unternehmens PLANLICHT anzusehen ist. Voraussetzung für die Gewährung der Garantie ist die online-Registrierung der jeweiligen Installation (Projekt, Gebäude) bis spätestens 66 Tage nach jeweiligen Rechnungsdatum auf WWW.PLANLICHT.COM unter dem Menüpunkt „Service | Garantie 66“. Mit der jeweiligen Registrierung bestätigt der Kunde, Firmenkunde zu sein; mangelhafte, falsche oder irreführende Angaben können zu einer Aufhebung der Garantie führen. Die für diese Registrierung erforderlichen Mindestangaben von Firmenkunden beinhalten neben den Kontaktdaten des Kunden jedenfalls die Auftragsnummer sowie den Installationsort der Produkte. Wir behalten uns vor, erforderlichenfalls weitere Angaben zu verlangen.
2. Im Garantiefall ist der Kunde verpflichtet, uns innerhalb von 6 Tagen ab Feststellen, dass einzelne oder alle der für die Garantie registrierten Produkte Produktions- und/oder Materialfehler aufweisen, dies schriftlich bekannt zu geben. Sodann ist uns eine angemessene Frist für die Prüfung der Produkte zu gewähren. Sollte dafür die Rücksendung der betreffenden Produkte an uns erforderlich sein, sind die Kosten dafür vom Kunden zu tragen. Treten Bedenken und Bauteilen wie etwa LEDs 0,2%/1000 Betriebsstunden, wenn in den Produkt- und Anwendungsspezifikationen nichts Gegenteiliges festgelegt wurde und soweit nicht ausdrücklich etwas anders angegeben wurde. Außerdem gelten bei LED-Modulen ein Lichtstromrückgang von bis zu 1,0%/1000 Betriebsstunden sowie eine Lichtfarbpunktverschiebung über die Lebensdauer als normal und dies fällt nicht unter die Garantie. Es kann aufgrund des technischen Fortschritts und der nutzungsbedingten Veränderung des Lichtstroms zu Abweichungen in den Lichteigenschaften gegenüber dem ursprünglichen Produkt kommen, wenn LED Module ersetzt werden.
4. Diese Herstellergarantie ist eine Ersatzteilgarantie. Sämtliche Ersatzprodukte oder -teile können neue oder wiederverwertete Materialien enthalten, die im Vergleich zu neuen Produkten oder Teilen hinsichtlich Leistung und Zuverlässigkeit gleichwertig sind. Hinsichtlich Design oder Abmessungen kann das Ersatzprodukt vom ursprünglichen Produkt abweichen. Wir garantieren, dass Ersatzprodukte oder -teile für die restliche Zeit des anwendbaren Garantiezeitraums für das Produkt, das ersetzt wird bzw. in dem sie eingebaut werden, keine Herstellungsmängel oder Materialfehler aufweisen.
5. Die Garantie bezieht sich nur auf Produkte,
 - a) die gemäß den Produkt- und Anwendungsspezifikationen (Produktdatenblätter, Kataloge oder ähnliches) verwendet wurden und fachmännisch gemäß Montageanleitung durch ein konzessioniertes Elekronunternehmen installiert und in Betrieb gesetzt wurden;
 - b) an denen keine Änderungen oder Reparaturen vorgenommen wurden, zu denen wir nicht unsere schriftliche Zustimmung gegeben haben;
 - c) deren Grenzwerte für externe Einflussfaktoren, wie Temperaturen und Spannungen, nicht überschritten wurden und die keinen nicht bestimmungsgemäßen mechanischen Belastungen ausgesetzt wurden;
 - d) die vom Kunden ordnungsgemäß und entsprechend den im Kaufvertrag vereinbarten Zahlungsbedingungen bezahlt wurden;
 - e) die ausschließlich mit Leuchtmittel ausgestattet wurden, die den geltenden IEC-Spezifikationen entsprechen; und
 - f) deren Wartungserfordernissen fachmännisch Genüge getan wurde.
6. Die Garantie bezieht sich nicht auf
 - a) alle im Zusammenhang mit der Mängelbehebung entstehenden Nebenkosten, wie z.B. für Ein- und Ausbau, Transport des fehlerhaften und des reparierten bzw. neuen Produkts, Entsorgung, Fahrt und Wegzeit, Hebevorrichtung, Gerüste, Verdienstausfall, Pönalen, Gutachterkosten, Mängelnachweis bzw. Neuinbetriebnahme;
 - b) normale Abnutzung und Verschleiß sowie Verschleißteile, wie beispielsweise alle Standard-Leuchtmittel und Batterien; ebenso Ventilatoren in Produkten mit LED-Leuchtmitteln, Softwarefehler, Bugs oder Viren;
 - c) Oberflächenbeschichtungen bzw. Kunststoffteile aus z.B. Polycarbonat und PMMA, die sich aufgrund des natürlichen Alterungsprozesses verfärben oder verspröden;
 - d) vorsätzliche oder fahrlässige Beschädigungen;
 - e) Sonderfertigungen, bei denen wir nach vom Kunden vorgelegten Plänen, Zeichnungen und Spezifikationen arbeiten;
 - f) Konstruktionsfehlern;
 - e) Einstellungen bzw. Parametrierungen an Anlagen, die sich aufgrund von Verschleiß, Ermüdung oder Verschmutzungen verändern;
 - f) Abweichungen des Produkts von Abbildungen oder Angaben in unseren Katalogen oder sonstigen Verkaufsunterlagen;
 - g) Mängel, die auf unvorhergesehene und unvorhersehbare Vorkommnisse, wie Zufall und/oder höhere Gewalt (einschließlich elektrische Entladungen, Blitze) zurückzuführen sind und bei denen ein Bezug auf Mängel im Herstellungsprozess des Produkts auszuschließen ist; und
 - h) elektronische Komponenten bzw. Produkte, die PLANLICHT als Handelsware vertreibt.
7. Es steht uns frei, den Mangel zu beheben oder einen von uns gewählten Ersatz in Form gleicher oder gleichwertiger Produkte zu leisten oder den Kaufpreis zu mindern bzw. zu erstatten, wenn sich nach Prüfung eines als Garantiefall gemeldeten Produkts herausstellt, dass es die behaupteten Mängel aufweist und diese durch die Garantieerklärung gedeckt sind. Der Kunde trägt alle mit der Garantieleistung entstehenden Nebenkosten, siehe insbesondere, aber nicht ausschließlich Punkt 6.a). Auch für im Rahmen der Garantieleistung notwendige Neuinbetriebnahmen, Softwareneuinstallationen oder Softwareupdates trägt der Kunde die Kosten.
8. Schlussbestimmungen
 - a) Diese Garantie gilt nur für Produkte mit einem Lieferdatum ab 01.09.2014.
 - b) Wir übernehmen keine über diese Garantie hinausreichende Haftung. Insbesondere haften wir im Rahmen dieser Garantie nicht für etwaige mittelbare Schäden, Sonder- oder Folgeschäden, Vermögensschäden einschließlich dem Verlust tatsächlicher oder erwarteter Gewinne, Zinsen, Erträge, erwarteter Einsparungen oder Geschäfte, Schädigungen des Firmenwerts, und Schäden jeglicher Art, die Dritten entstanden sind. Neben dieser Garantie bleibt unsere vertragliche Gewährleistung jedoch unverändert aufrecht.
 - c) Die Haftung aus dieser Garantie ist auf den Kaufpreis der betroffenen Produkte beschränkt. Sie ist gegenüber einer Haftung aus anderen rechtlichen Gründen subsidiär. Ein Anspruch auf zusätzliche bzw. den tatsächlichen Schadensbetrag erhöhende Leistungen oder Zahlungen kann nicht aus dieser Garantie hergeleitet werden.
 - d) Der Kunde kann die Garantie bzw. seine Rechte daraus nur mit unserer schriftlichen Zustimmung übertragen. Dritte haben kein Recht, eine der in dieser Garantie enthaltenen Bestimmungen durchzusetzen.
 - e) Es gilt das österreichische Recht. Die Bestimmungen des UN-Kaufrechts finden keine Anwendung.
 - f) Gerichtsstand für alle Streitigkeiten, die sich aus dieser Garantieerklärung ergeben, ist je nach Streitwerthöhe Schwaz oder Innsbruck.
 - g) Für den Fall, dass einzelne Bestimmungen dieser Garantieerklärung ganz oder teilweise unwirksam sind oder werden, wird dadurch die Gültigkeit der übrigen Bestimmungen nicht berührt. Die gänzliche oder teilweise unwirksame Bestimmung wird durch eine gültige ersetzt, die dem Parteiwillen möglichst nahe kommt. Mündliche Nebenabsprachen gelten als unwirksam.

























































WARRANTY CONDITIONS

The planlicht GmbH & Co KG, Au 25, A-6134 Vomp grants the following manufacturer's guarantee of 66 months by their respective sales offices on products of PLANLICHT:

In accordance with the following terms and conditions described in more detail below, we warrant that products distributed under the trademark "PLANLICHT" are free of production and/or material defects during the guarantee period of 66 months (5 ½ years) counting from the invoice date in case of proper use.

1. Please note that insofar it is referred to customers in the following, the term "customer" signifies commercial dealer or, respectively, contractual partner of the company PLANLICHT. Prerequisite for the granting of the guarantee is that the respective installation (project, building) has been registered online within 66 days at the latest upon the respective date of invoice under WWW.PLANLICHT.COM under the menu item "Service | Warranty 66". With the respective registration, the customer confirms being a corporate customer; the provision of inadequate, false or misleading information may lead to the withdrawal of the guarantee. Besides the contact details of the customer, the minimum information on the corporate customers required for the registration in any case includes the order number as well as the installation site of the products. We reserve the right to ask for further information, if necessary.
2. In case of the occurrence of the guaranteed event, the customer is obliged to notify us within 6 days upon discovery of the defect in writing of the fact that individual or all of the products registered for the guarantee show production and/or material defects. Thereafter, we shall be granted an adequate period of time to verify the products. Should it therefore be necessary to return the products concerned to us, the costs thereof shall be borne by the customer. Should concerns appear regarding the existence of the alleged defects or regarding the fact that the alleged defect is attributable to a production and/or material defect covered by the guarantee, the customer shall bear the burden of proof regarding the existence of the defect and/or the causality of a production and/or material defect covered by this guarantee; same has to provide the respective evidence and bear the external costs of the verification (e.g. expert's opinions) independent of their outcomes or their result.
3. The guarantee covers persistent malfunctions of products that are attributable to substantial production and/or material defects, in so far as they exceed the nominal failure rate. The nominal failure rate is 0.2%/1000 operating hours with electronic operating devices and components such as LEDs, unless otherwise determined in the product and application specifications and unless specified expressly otherwise. Furthermore, a reduction in luminous flux of up to 1.0%/1000 operational hours as well as a colour point shift over the life span of LED modules shall be deemed normal and this shall not be covered by guarantee. Deviations regarding the properties of the light may occur in relation to the original product, in case that LED modules are replaced, due to the technological progress and the usage-related alterations of the luminous flux.
4. This manufacturer's guarantee is a spare-part guarantee. All substitute products or spare-parts may contain new or recycled materials that are equivalent to new products or parts as regards their performance and reliability. As regards design or dimensions, the substitute product may deviate from the original product. We warrant that the substitute products or spare-parts do not show any production or material defects during the remaining warranty period applicable on the product that is replaced or, respectively, in which they are installed.
 - a) that were used in accordance with the product and application specifications (product data sheets, catalogues or similar) and that were installed and put into operation in a professional manner by a licensed electro-enterprise;
 - b) were not subject to changes or repair in which we did not consent in writing;
 - c) the threshold limit value for external influencing factors of which, such as temperature and tension, were not exceeded and that were not exposed to mechanical stress that does not correspond to their designated use;
 - d) that were duly paid by the customer in accordance with the payment conditions agreed upon in the purchase contract;
 - e) that were exclusively equipped with lamps that correspond the IEC specifications applicable; and
 - f) the servicing requirements of which were satisfied by a professional.
6. The guarantee does not apply to
 - a) all incidental costs in connection with the rectification of defects, such as for example costs for assembly and disassembly, transport of the defective and the repaired or, respectively, the new product, disposal, travel and travel time, lifting device, scaffolds, loss of earnings, penalties, expert's costs, proof of defects or, respectively, new start-up;
 - b) normal wear and tear as well as wear parts, such as for example all standard lamps and batteries; also fans in products with LED lamps, software errors, bugs or viruses;
 - c) surface coatings or, respectively plastic components made of, e.g. polycarbonate and PMMA, which discolour or become brittle due to the natural aging process;
 - d) intentional or negligent damage;
 - e) custom-made devices where we work based on the plans, drawings and specifications presented by the customer;
 - f) construction errors;
 - e) [sic.] adjustments or, respectively parameterization of facilities that change due to wear, fatigue or contamination;
 - f) [sic.] deviations of the product from illustrations or information provided in our catalogues or in other sales documents ;
 - g) defects that are attributable to unforeseen and unforeseeable events, such as hazard and/or force majeure (including electrical discharges, lightning) and where a connection with defects during the production process of the product can be excluded; and
 - h) electronic components or, respectively products that are distributed by PLANLICHT as trade goods.
7. We shall be free to remedy the defect or to replace - in a freely chosen form - the product by the same or similar or to reduce or, respectively, reimburse the purchase price if it turns out after verification of the product which was notified to be subject to guarantee that it is affected by the alleged defects and that these are covered by the declaration of guarantee. The customer bears all incidental costs incurred due to the performance of the guarantee obligation, see in particular, but not exclusively point 6.a). The customer shall also bear the costs for new start-ups, software installations or software updates necessary in the course of the fulfilment of the guarantee obligation.
8. Final provisions
 - a) This guarantee shall only be applicable to products with a delivery date as of 01-09-2014.
 - b) We shall not assume any liability exceeding this guarantee. We are in particular not liable under this guarantee for any indirect damages, special or consequential damages, financial losses, including the loss of actual and expected profits, interests, income, expected savings or deals, damages to goodwill and damages of any kind whatsoever that were inflicted on third parties. Our contractual guarantee obligation shall however be not affected by this guarantee.
 - c) The liability resulting from this guarantee is limited to the purchase price of the products concerned. It is subsidiary to the liability out of any other legal title. An entitlement to claim any additional performance or payment or, respectively, any performance or payment actually increasing the damage sum cannot be deduced from this guarantee
 - d) The customer may only transfer the guarantee or, respectively, his rights thereof with our written consent. Third parties are not entitled to enforce one of the conditions contained in this guarantee.
 - e) Austrian law is applicable. The provisions of the UN Sales Convention are not applicable.
 - f) Place of jurisdiction for all disputes resulting from this guarantee declaration shall be Schwaz or Innsbruck, depending on the value of litigation.
 - g) In case that an individual provision of this guarantee declaration are or become invalid in parts or in whole, the validity of the remaining provisions shall not be affected thereby. The provision which is invalid in parts or in whole shall be replaced by a valid one that comes closest to the intention of the parties. Oral side agreements are invalid.



 CE Prüfzeichen CE marking	 Abstand 0,5m Distance 0.5m
 UKCA Prüfzeichen UKCA marking	 Drehbar Rotatable
 230 Volt 230 volts	 Schwenkbar Pivoting
 Schutzklasse 1 Protection class 1	 Kürzbar Shortenable
 Schutzklasse 2 Protection class 2	 LED LED
 Schutzklasse 3 Protection class 3	 LED-Leuchtmittel Gu5.3 LED bulb Gu5.3
 IP10 IP10	 Ohne Leuchtmittel Without bulb
 IP20 IP20	 UGR < 16 UGR < 16
 IP40 IP40	 UGR < 19 UGR < 19
 IP44 IP44	 3x16A maximal zulässiger Strom 3x16A Maximum permissible current 3x16A
 IP50 IP50	 2x max. 2A 50V maximal zulässiger Strom (2x max. 2A 50V) Maximum permissible current (2x max. 2A 50V)
 IP54 IP54	 Prüfzeichen ENEC ENEC marking
 Innenanwendung Indoor	 RGB RGB
 Standard RAL optional, spezielle RAL auf Anfrage Standard RAL available, special RAL on request	 Human Centric Lighting (HCL) Human Centric Lighting (HCL)
 Elektronischer Transformator / Konverter inklusive Electronic transformer/converter included	 DIM DIM
 Elektronischer Transformator / Konverter nicht enthalten Electronic transformer/converter not included	 DALI DALI
 Tageslichtsensor Daylight sensor	 Bluetooth Bluetooth
 CASAMBI CASAMBI	 Steuerbar über Smartphone/Tablet Controllable via smartphone/tablet
 MATTER MATTER	 Nachtmodus Nightmode
 Lebensdauer Lifetime	 Logo Thread Thread Logo
 MacAdam 3 MacAdam 3	 PHASE CUT Phase cut/Triac Phase cut/Triac
 CRI > 80 CRI > 80	 1-10V 1-10V
 CRI > 90 CRI > 90	 PUSH DIM Push DIM Push DIM
 Dynamisches Weiß (HCL) Dynamic white (HCL)	 SWITCH DIM Switch DIM Switch DIM
 DT8 DT8	 IP68 IP68
 Batteriebetriebenes Notlicht Battery-powered emergency light	 IP67 IP67
 Ballwurfsicher Ballproof	 IP66 IP66
 RGBW RGBW	 Verschiedene Kabel auf Anfrage erhältlich Various cables available on request
 IK07 IK07	

A large grid area for taking notes, consisting of a grid of small squares.

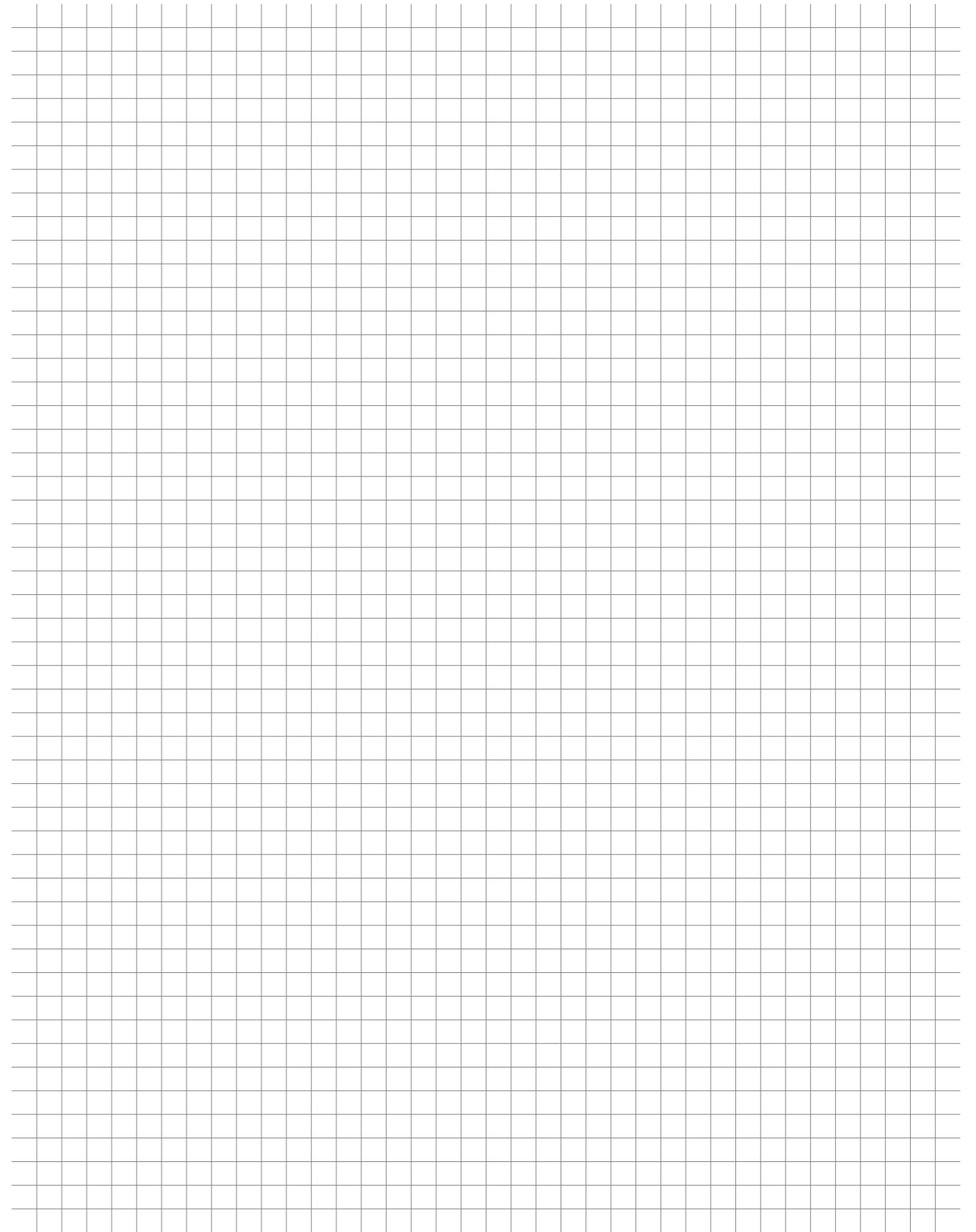
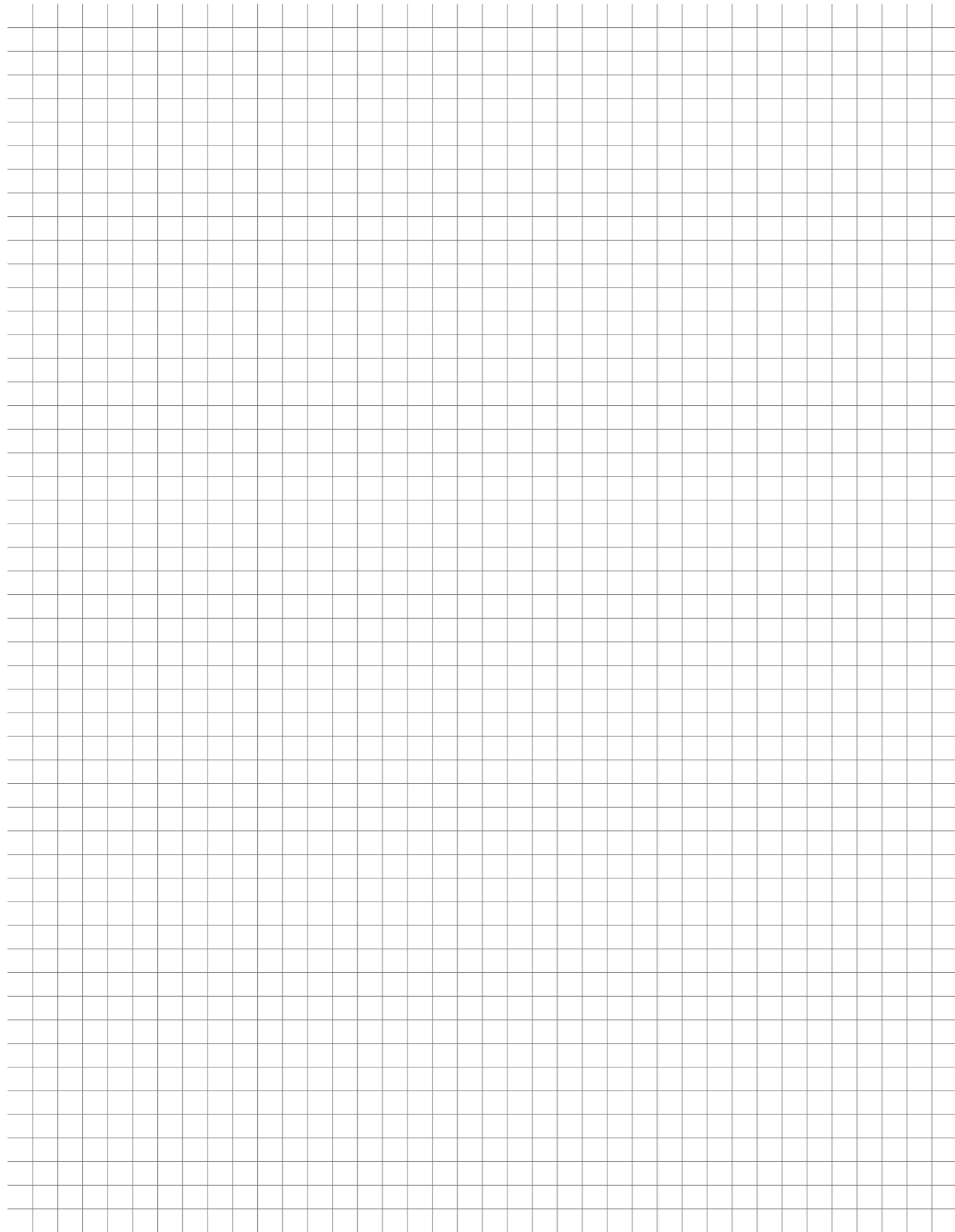

WICHTIGE HINWEISE

Dieser Katalog richtet sich ausschliesslich an gewerbliche Kunden. Die in diesem Katalog angegebenen Werte sind Bemessungswerte und unterliegen produktionsbedingten Toleranzen*. Alle angeführten Angaben – insbesondere Grössen-, Material-, Farb- und technische Angaben – entsprechen dem Stand zum Zeitpunkt des Drucks und dienen ausschliesslich zur Information. Der Herausgeber haftet nicht für Satz- und Druckfehler sowie für Abweichungen der Produkte von Abbildungen und Angaben. PLANLICHT behält sich vor, jederzeit ohne Ankündigung Änderungen an Produkten vor zu nehmen. Es gelten die Allgemeinen Geschäftsbedingungen der planlicht GmbH & Co KG, die unter WWW.PLANLICHT.COM eingesehen werden können.

Technische Kennzahlen, angeführte Werte und die Piktogramme betreffen zumindest einen aber nicht zwingend alle Artikel der jeweiligen Leuchtenfamilie, exakte Angaben je Artikel finden Sie im Online-Katalog bzw. in PLANLICHT-Verkaufsbelegen und Datenblättern.

* Leistung, Lichtstrom und Farbtemperatur unterliegen durch den Einsatz von elektronischen Bauteilen produktionsbedingten Toleranzen.
Toleranzen Leistung und Lichtstrom: +/- 10%. Toleranz Farbtemperatur: +/- 150 K. Lichtstrom dynamisch weiss bei 2700 K.

IMPORTANT REMARKS

This catalogue is reserved for professionals only. The values published in this catalogue are rated values, which can slightly change for reasons related to the production process. The published data such as dimensions, materials, colours and technical data are valid at time of printing, and exclusively provided for informational purposes. The editor takes no responsibility for typographical and print errors, as well as for any differences in the products, pictures and data. PLANLICHT reserves the right to change the products at any time and without any notice. The Terms and Conditions of planlicht GmbH & Co KG (available on WWW.PLANLICHT.COM) shall apply.*

Key technical specifications, listed values as well as the pictogram bar relate to at least one but not necessarily all items of the respective luminaire family, exact details for each item can be found in the online web catalogue or in PLANLICHT sales documents and data sheets.

* The power output, luminous flux and colour temperature can be slightly different due to specific electronic components used in the manufacturing process. The power output and luminous flux can differ by +/- 10%. The colour temperature can differ by +/- 150K. Luminous flux dynamic white at 2700K.

REMARQUES IMPORTANTES

Ce catalogue est exclusivement destiné aux professionnels. Les valeurs publiées dans ce catalogue sont des valeurs calculées, pouvant légèrement changer pour des raisons liées au processus de fabrication. Les données techniques et autres informations (dimensions, matériaux, couleurs...) sont celles applicables au moment de l'impression du catalogue, et uniquement fournies à titre informatif. L'éditeur décline toute responsabilité en cas d'erreur de frappe, d'impression et pour tout autre différence concernant les produits, images et données publiées. PLANLICHT se réserve le droit de modifier les produits à sa discrétion, à tout moment et sans préavis. Les conditions générales de vente de planlicht GmbH & Co KG applicables sont consultables sur WWW.PLANLICHT.COM.*

Les caractéristiques techniques, les valeurs indiquées et la barre de pictogrammes concernent au moins un article de la famille de luminaires concernée, mais pas nécessairement tous. Vous trouverez des informations exactes par article dans le catalogue en ligne ou dans les documents de vente et les fiches techniques de PLANLICHT.

* La puissance, le flux lumineux et la température de couleur peuvent légèrement différer en raison de l'utilisation de composants électroniques spécifiques dans le processus de production. La puissance et le flux lumineux peuvent différer de +/- 10%. La température de couleur peut différer de +/- 150 K. Flux lumineux blanc dynamique à 2700 K.



6134 Vomp, Austria, Au 25
Tel. +43-5242-71608, Fax +43-5242-71283
info@planlicht.com
WWW.PLANLICHT.COM

IMPRINT

Publisher: planlicht GmbH & Co. KG, Vomp
Creative Concept: Katrin Atzinger
Graphic Design: Beatrice Praxmarer, Christoph Höflinger
Print: Himmer GmbH Druckerei & Verlag, Augsburg/DE
© 2024



WWW.PLANLICHT.COM