



p.thirty



p.thirty

SMALL BUT

POWERFUL

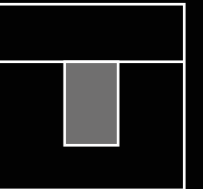

Surface

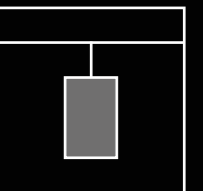

Pendant

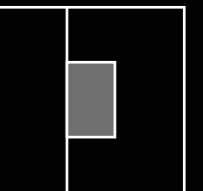

Wall

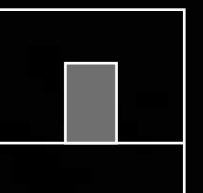

Recessed



Systems



Floor lamp

P.THIRTY FEATURES



MINIMALISTISCHES PROFIL
Eine Profilhöhe von nur 31 mm.

Minimalistic profile



HOHE LICHTLEISTUNG
Grund- und Arbeitsplatzbeleuchtung

High performance



HOHER SEHKOMFORT
Homogene Opal-Diffusoren und blendfreie Mikroprismen.

Eye comfort



INTEGRIERTES VORSCHALTGERÄT
Treiber immer vollständig im Profilgehäuse integriert.

Driver integrated

SPRITZWASSERGESCHÜTZT
Erhältlich in der IP44-Version für Badezimmer.

Splash water proof

MODULARE SYSTEMLÖSUNG
Verbindung von Modulen, um individuelle Beleuchtungslösungen zu schaffen.

Modular system

BELEUCHTETE ENDKAPPEN
U-förmige Diffusoren können mit beleuchteten Endkappen ausgerüstet werden.

Illuminated end caps

RUNDE VARIANTE
Auch als Ringleuchten-Pendant verfügbar: sinus p.thirty.

Round variant



VERSCHIEDENE DIFFUSOREN | DIFFERENT DIFFUSERS

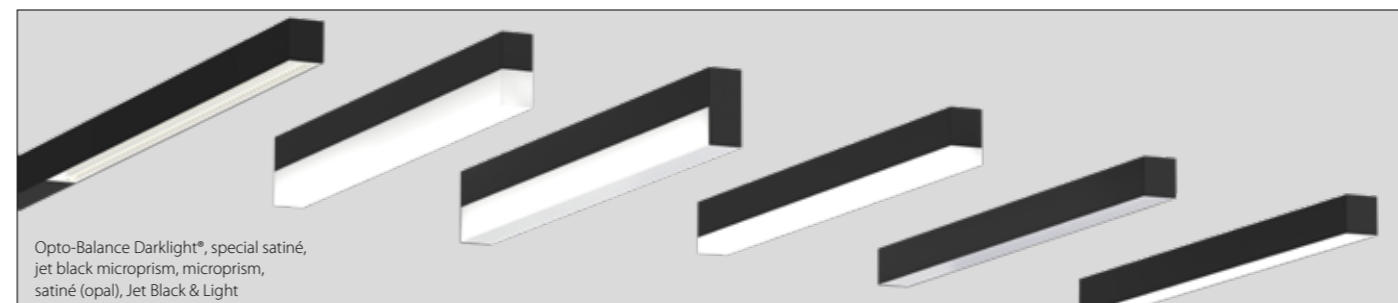

Opto-Balance Darklight®, special satiné, jet black microprism, microprism, satiné (opal), Jet Black & Light

SPEZIELLE ENDKAPPEN | SPECIAL END CAPS

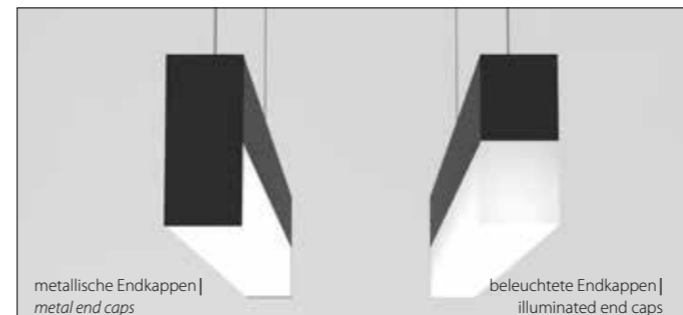

metallische Endkappen | metal end caps

beleuchtete Endkappen | illuminated end caps

OPTO-BALANCE DARKLIGHT® (INCL. OFFICE SPECIAL VARIANTE)



P.THIRTY - SMALL BUT POWERFUL

Projekt: Raiba Straubing | Deutschland
Foto: © Ulrich Buha

Project: Raiba Straubing | Germany
Photo: © Ulrich Buha



P.THIRTY | STEHLEUCHTENSYSTEM

P.THIRTY | FLOOR & TABLE LAMPS

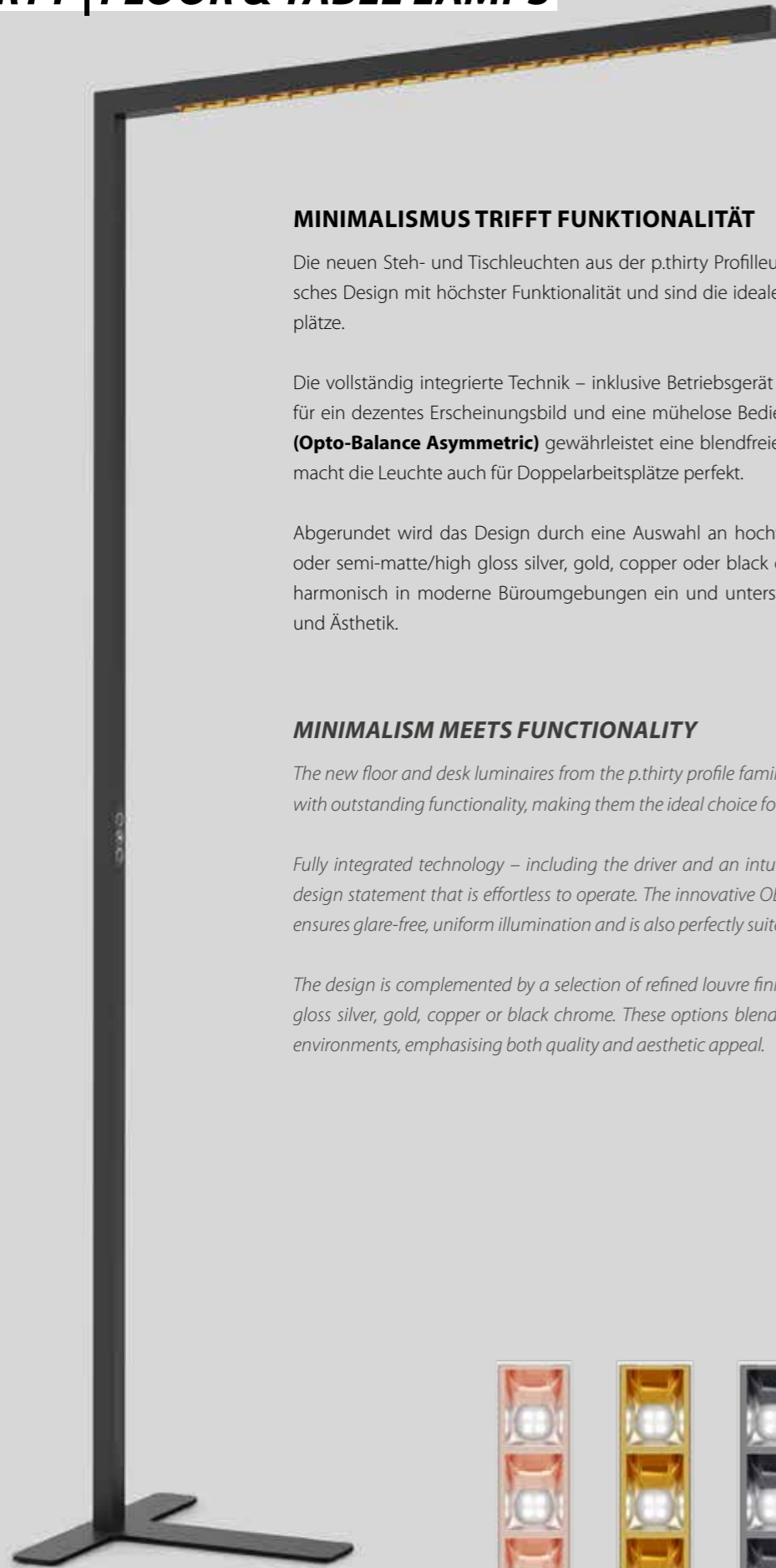

MINIMALISMUS TRIFFT FUNKTIONALITÄT

Die neuen Steh- und Tischleuchten aus der p.thirty Profilleuchten-Familie vereinen minimalistisches Design mit höchster Funktionalität und sind die ideale Lösung für ergonomische Arbeitsplätze.

Die vollständig integrierte Technik – inklusive Betriebsgerät und intuitivem Touchpanel – sorgt für ein dezentes Erscheinungsbild und eine mühelose Bedienung. Der innovative **OBA-Raster (Opto-Balance Asymmetric)** gewährleistet eine blendfreie, normgerechte Ausleuchtung und macht die Leuchte auch für Doppelarbeitsplätze perfekt.

Abgerundet wird das Design durch eine Auswahl an hochwertigen Rasterfarben: silver matte oder semi-matte/high gloss silver, gold, copper oder black chrome. Diese Varianten fügen sich harmonisch in moderne Büroumgebungen ein und unterstreichen den Anspruch an Qualität und Ästhetik.

MINIMALISM MEETS FUNCTIONALITY

The new floor and desk luminaires from the p.thirty profile family combine a clean, minimalist design with outstanding functionality, making them the ideal choice for ergonomic workspaces.

Fully integrated technology – including the driver and an intuitive touch panel – creates a discreet design statement that is effortless to operate. The innovative OBA louvre (Opto-Balance Asymmetric) ensures glare-free, uniform illumination and is also perfectly suited for dual workstations.

The design is complemented by a selection of refined louvre finishes: silver matte or semi-matte/high gloss silver, gold, copper or black chrome. These options blend seamlessly into contemporary office environments, emphasising both quality and aesthetic appeal.

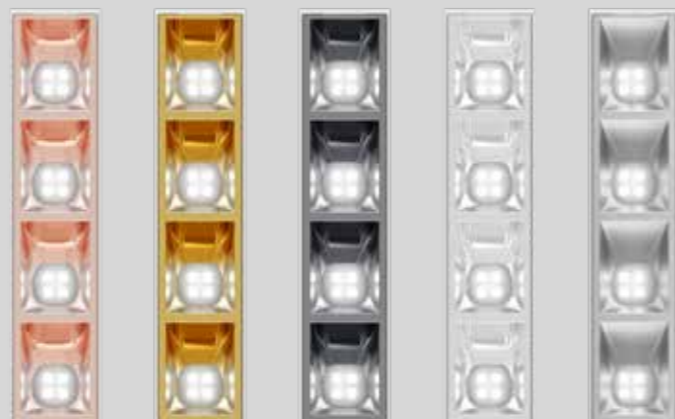

- **Flexibel wie nie:** Das p.thirty Stehleuchtersystem bietet eine Stehleuchte wahlweise mit U- oder T-Bodenplatte sowie eine Tischleuchte mit Klemmmontage oder direkter Integration in den Tisch – für maximale Anpassungsfähigkeit in jeder Arbeitsumgebung.
- **Licht mit Köpfchen:** Die OBA-Technologie (Opto-Balance Asymmetric) kombiniert einen doppelt asymmetrischen Diffusor mit Reflektoren für direkte und Linearlinsen für indirekte Beleuchtung. Die innovative Lichtlenkung sorgt für eine spezielle Abstrahlcharakteristik.
- **Kein Blenden, kein Schattenspiel:** Die asymmetrische Lichtlenkung reduziert Reflexionen auf Monitoren und Tischoberflächen und minimiert störende Schatten für ergonomisches, augenschonendes Arbeiten.
- **Kompakt, aber oho:** Dank cleverer Abstrahlcharakteristik ist der Leuchtenkopf kürzer als die Tischlänge – für ein harmonisches Zusammenspiel von Design und Funktion unter Einhaltung aller Normen.
- **Passt sich an – überall:** Dank symmetrischer Querausstrahlung kann die Leuchte flexibel links, rechts oder direkt auf den oder im Tisch montiert werden. So profitieren sowohl Links- als auch Rechtshänder von einer schattenfreien Ausleuchtung. Zudem bleibt die Beleuchtungsstärke auch bei höhenverstellbaren Schreibtischen konstant.
- **Schlank, aber vollgepackt:** Trotz minimalistischem Profilquerschnitt ist die gesamte Technik – inklusive Betriebsgerät und Touchpanel – vollständig in die Leuchte integriert.
- **Effizient für zwei:** Eine einzige Leuchte kann zwei Arbeitsplätze mit normkonformer, blendfreier Beleuchtung versorgen – für optimale Lichtverhältnisse und produktives Arbeiten.

- **Flexibility redefined:** *The p.thirty floor luminaire system includes a floor model with U- or T-base plates and a desk luminaire with clip-on or in-desk mounting – delivering maximum adaptability in any workspace.*
- **Smart lighting with a twist:** *OBA technology (Opto-Balance Asymmetric) combines a dual-asymmetric diffuser with reflector lenses for direct light and linear lenses for indirect illumination, creating a distinctive light distribution.*
- **No glare, no shadows:** *Asymmetric light control reduces reflections on screens and surfaces while minimising distracting shadows for ergonomic, eye-friendly working conditions.*
- **Compact yet powerful:** *A clever light distribution allows for a shorter luminaire head than the desk length, ensuring a harmonious balance of design and functionality while meeting all standards.*
- **Adaptable everywhere:** *Symmetrical cross-beam emission enables flexible mounting on the left, right or directly on or in the desk, providing shadow-free lighting for both left- and right-handed users. Light levels remain consistent even with height-adjustable desks.*
- **Slim yet fully equipped:** *Despite its minimalist profile, all technology – including driver and touch panel – is fully integrated within the luminaire.*
- **Efficient for two:** *A single luminaire delivers compliant, glare-free lighting for up to two workstations, ensuring optimal conditions for productive work.*



INSPIRATION

Produkt: p.thirty

INSPIRATION

Product: p.thirty

**P.THIRTY
JET BLACK MICROPRISM**



EINE KLEINE PROFILLEUCHE SCHREIBT GROSSE GESCHICHTEN.

KLEIN, ABER KRAFTVOLL

p.thirty ist das kleinste der PLANLICHT Profileuchten und überzeugt mit einem minimalistischen Design und großer Variabilität. Eine herausragende Leistung, hoher Sehkomfort und integrierte Betriebsgeräte sind selbstverständlich.

SMALL PROFILE LUMINAIRE WRITES HUGE STORIES.

SMALL BUT POWERFUL

p.thirty is the smallest of the PLANLICHT profile luminaires and impresses with a minimalistic design and great variability. Great performance, high eye comfort and an integrated driver go without saying.

JET-BLACK-MIKROPRISMATISCH

Der spezielle Diffusor in der Farbe Jet Black Mikroprisma verleiht der Leuchte einen außergewöhnlichen Look.

JET BLACK MICROPRISM

The special diffuser colour Jet Black Mikroprism provides an extraordinary look.

**P.THIRTY
OPTO-BALANCE DARKLIGHT®**



P.THIRTY OPTO-BALANCE DARKLIGHT® | KOMPROMISSLOS PUNKTGENAU

p.thirty Opto-Balance Darklight® besticht durch die zonierte Lichtausgabe, ihre extrem kleinen Abmessungen und mit integriertem Betriebsgerät trotz der ausgeklügelten Lichtlenkungstechnologie. Durch die Bündelung des Raumlichtes wird die zu beleuchtende Fläche optimal erhellt und das Licht landet exakt dort, wo es gewünscht ist. Kompromisslos punktgenau. Zudem weist die neue OBD-Variante in allen Montagearten auch

rein direkt strahlend und in jeglicher Bestromung einen UGR-Wert unter 16 auf und sorgt somit für normkonformen Sehkomfort. In der Variante als Hängeleuchte mit direkt/indirekter Lichtabgabe liegt der Blendwert sogar unter 6 – einem sagenhaft niedrigen Wert, der selbst in den gängigsten Beleuchtungsfibeln nicht abgebildet wird. Die Spezialausführung „office special“ überzeugt zusätzlich durch die Reduktion der Wartungs- und Betriebskosten.

P.THIRTY OPTO-BALANCE DARKLIGHT® | UNCOMPROMISINGLY SPOT-ON

p.thirty Opto-Balance Darklight® (OBD) impresses with its zoned light output, its extremely small dimensions and with an integrated driver despite its sophisticated light focusing technology. By concentrating the light output, the respective workspace surface is optimally illuminated and no light is wasted, as it arrives exactly where it is needed. Uncompromisingly precise and spot-on.

In addition, the new OBD version has an UGR value of less than 16 in all mounting types, all output versions and even with solely direct light distribution, thus ensuring visual comfort according to unified standards. As a pendant luminaire with direct/indirect light output, the glare value is even below 6 – a value so low that it is not even mentioned in most literature about lighting design.

VORTEILE

- Optimal ausbalanciertes Licht
- Innovative Lichttechnologie
- Maximaler Sehkomfort
- Minimalistisches Design & Größe
- Trendige metallische Optikbeschichtungen

BENEFITS

- Optimally balanced light
- Innovative lighting technology
- Maximum visual comfort
- Minimalist design & size
- Trendy metallic reflector coatings

P.THIRTY PROJEKTE
P.THIRTY PROJECTS



INSPIRATION

Produkt: p.thirty

INSPIRATION

Produkt: p.thirty



RAIBA STRAUBING | DEUTSCHLAND

Produkt: p.thirty
Foto: © Ulrich Buha

RAIBA STRAUBING | GERMANY

Product: p.thirty
Photo: © Ulrich Buha

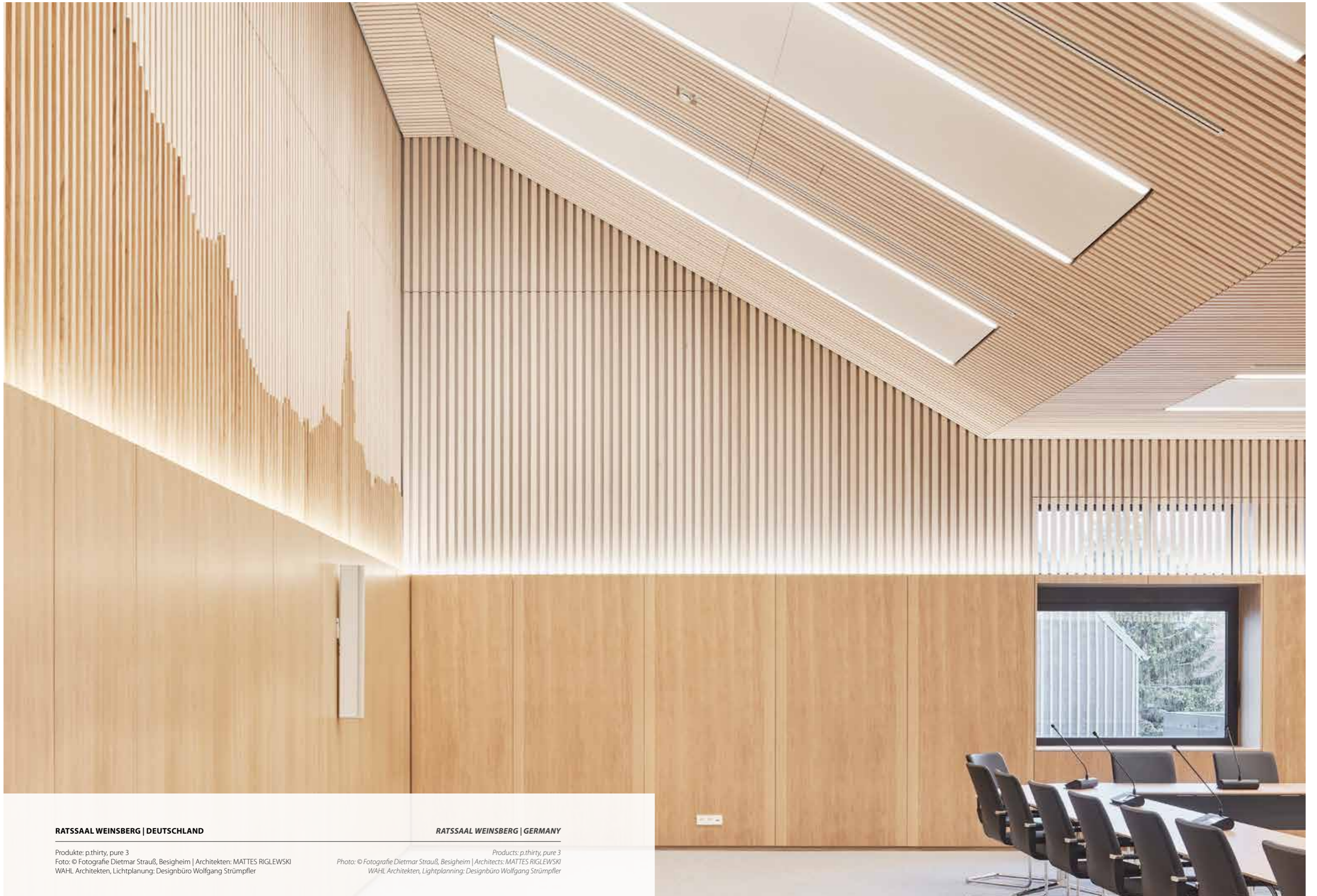

RATSSAAL WEINSBERG | DEUTSCHLAND

Produkte: p.thirty, pure 3
Foto: © Fotografie Dietmar Strauß, Besigheim | Architekten: MATTES RIGLEWSKI
WAHL Architekten, Lichtplanung: Designbüro Wolfgang Strümpfler

RATSSAAL WEINSBERG | GERMANY

Products: p.thirty, pure 3
Photo: © Fotografie Dietmar Strauß, Besigheim | Architects: MATTES RIGLEWSKI
WAHL Architekten, Lightplanning: Designbüro Wolfgang Strümpfler

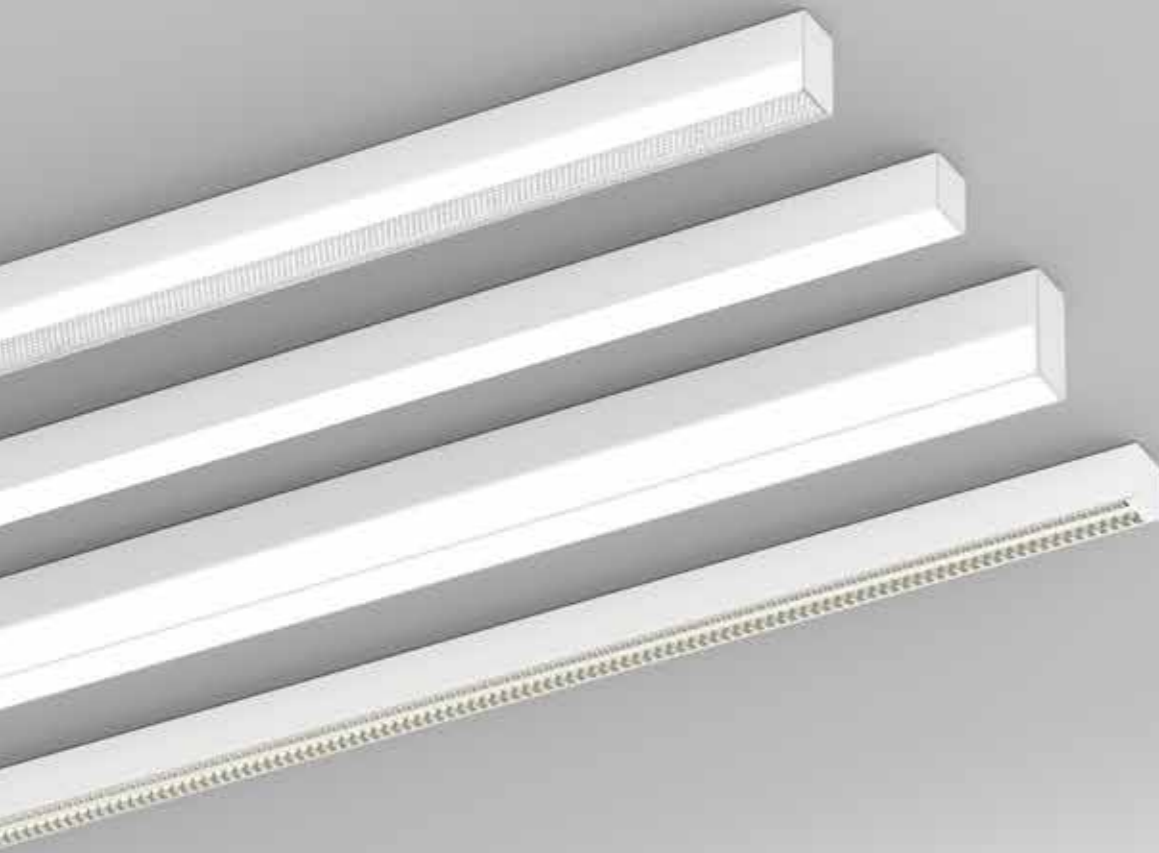

1 SIZE

557 mm (non-dim)	055
827 mm	082
1187 mm	118
1457 mm	145
2899 mm	289
3531 mm	353
4341 mm	434

2 COLOUR

	silver	9006
	white	9016
	black	9005
	RAL of your choice	

3 LED

	2700 K, CRI > 90
	3000 K, CRI > 90
	4000 K, CRI > 90
	4000 K, CRI > 80

4 OUTPUT / CONTROL

927	DIFFUSER		
930		low output non-dim	L1
940		low output DALI	L3
840		high output non dim (557 mm)	H1
		high output DALI	H3
	OBD (Opto-Balance Darklight®)		
H1		high output non dim	H1
H3		high output DALI	H3
V1		very high output non-dim (not 827mm)	V1
V3		very high output DALI (not 827mm)	V3

5 OPTIC

	satiné	S
	jet black & light	J
	microprism*	M
	U-shaped satiné, 15 mm	U
	U-shaped satiné, 34 mm	Q
	U-shaped jet black microprism, 15 mm*	V
	Opto-Balance Darklight® BAP high-gloss black chrome*	Z
	Opto-Balance Darklight® BAP high-gloss copper*	K
	Opto-Balance Darklight® BAP high-gloss gold*	G
	Opto-Balance Darklight® BAP high-gloss silver*	B

* UGR-optimised, configure online

P30A 1-2 C1 3 4 5

P30A082-9016C1930H35 Surface, 827 mm, white, IP20, direct, 3000 K, CRI > 90, high output DALI, satiné (order sample)

► Configure online on KATALOG.PLANLICHT.COM

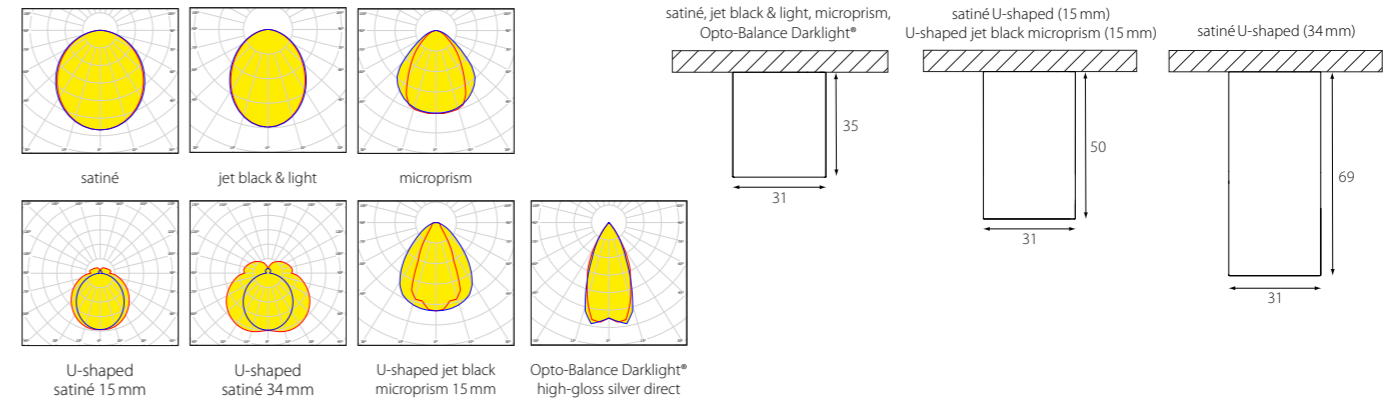

LUMINOUS FLUX (LM) / SYSTEM POWER (W), 4000 K, CRI > 80

4000 K satiné CRI > 80	low output	high output	
557 mm	930 lm / 8 W	1324 lm / 11,5 W	0,6 kg
827 mm	1388 lm / 10,5 W	1981 lm / 15,5 W	0,8 kg
1187 mm	1999 lm / 14,5 W	2855 lm / 21 W	1,1 kg
1457 mm	2457 lm / 17 W	3512 lm / 25 W	1,3 kg
2899 mm	4895 lm / 34 W	7008 lm / 50 W	2,5 kg
3531 mm	5961 lm / 43 W	8537 lm / 62 W	3,0 kg
4341 mm	7331 lm / 51 W	10503 lm / 74 W	3,7 kg

(based on optic Q)

COMPARE COVER 1457 MM, 4000 K, CRI > 80

	low output	high output	very high output
satiné	2457 lm	3512 lm	
jet black & light	506 lm	723 lm	
microprism*	2534 lm	3624 lm	
U-shaped satiné (15 mm)	2588 lm	3710 lm	
U-shaped satiné (34 mm)	2724 lm	3903 lm	
U-shaped jet black microprism (15 mm)	1419 lm	2020 lm	
Opto-Balance Darklight® high-gloss silver		1941 lm	3836 lm

COMPARE LIGHT COLOUR 1457 MM, SATINÉ, LOW OUTPUT

	3512 lm	2457 lm
4000 K, CRI > 80		
2700 K, CRI > 90	2637 lm	1845 lm
3000 K, CRI > 90	2769 lm	1937 lm
4000 K, CRI > 90	2862 lm	2002 lm

*Der angegebene Lichtstrom bezieht sich auf die Leuchte mit klarer mikroprismatischer Abdeckung. Die Leuchte wird mit satinierter Folie zur Erhöhung der Homogenität geliefert (Direkt strahlend: -13,9%, direkt/indirekt strahlend: -6,9% Lichtstrom). Die angegebenen Lichtstromwerte (lm) beziehen sich auf Leuchten mit einem weißen Gehäuse (RAL 9016). Je nach Gehäusefarbe und Länge reduzieren sich diese entsprechend (bezieht sich nur auf U-förmige Abdeckungen).

The indicated luminous flux corresponds to the luminaire with a clear microprismatic diffuser. The luminaire is delivered with a satinized-foil for increased homogeneity (direct: -13,9%, direct-indirect: -6,9% luminous flux). All figures of luminous flux (lm) are for fixtures with white housing (RAL 9016). Depending on the housing colour and length, the luminous flux is reduced accordingly. This only applies to U-shaped optics.

P.THIRTY PROFILE SYSTEM



Down to UGR ≤ 16 | up to 160 lm/W | up to 3013 lm/m | IEC 62471: Blue light hazard: RG 0 | DALI push switchDIM

p.thirty IP44

Aufbauleuchte
Surface luminaire

P.THIRTY | SURFACE

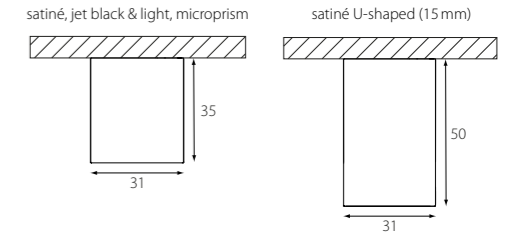
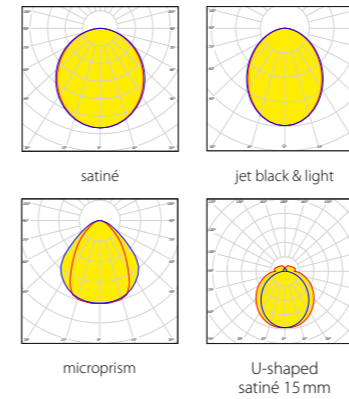
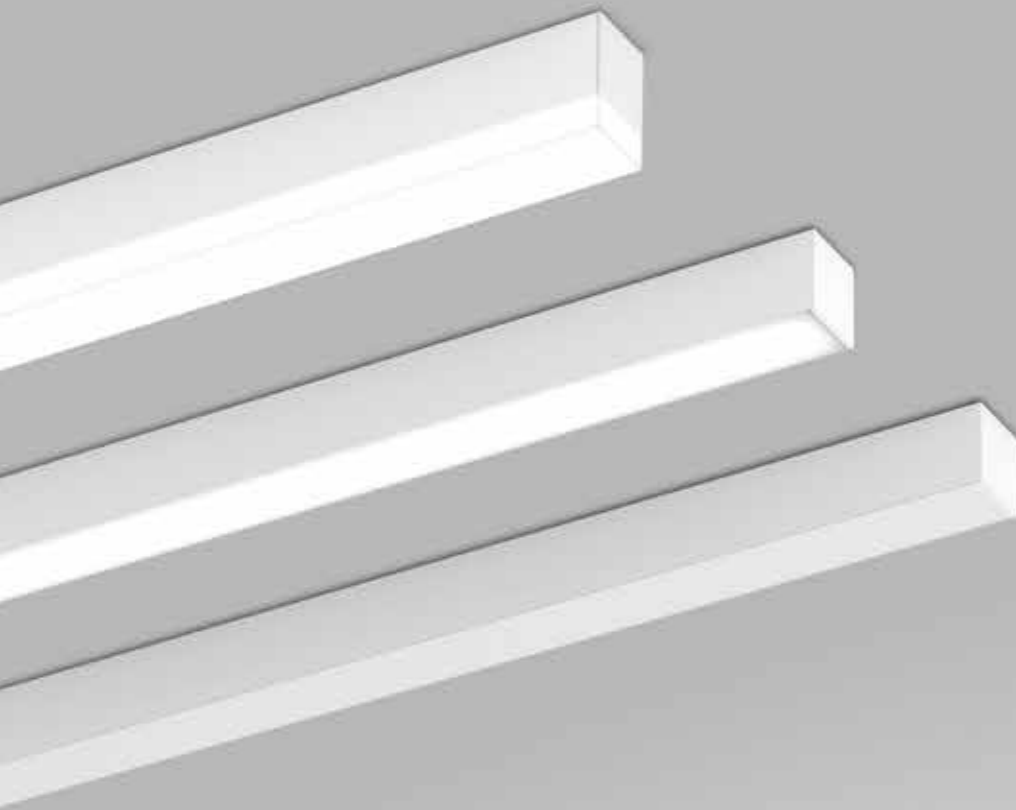

LUMINOUS FLUX (LM) / SYSTEM POWER (W), 4000 K, CRI > 80

4000K satiné CRI > 80	low output	high output	
557 mm	930 lm / 8 W	1324 lm / 11,5 W	0,6 kg
827 mm	1388 lm / 10,5 W	1981 lm / 15,5 W	0,8 kg
1187 mm	1999 lm / 14,5 W	2855 lm / 21 W	1,1 kg
1457 mm	2457 lm / 17 W	3512 lm / 25 W	1,3 kg

(based on optic Q)

COMPARE COVER 1457 MM, 4000 K, CRI > 80

	low output	high output
satiné	2457 lm	3512 lm
jet black & light	506 lm	723 lm
microprism*	2534 lm	3624 lm
U-shaped satiné (15 mm)	2588 lm	3710 lm

COMPARE LIGHT COLOUR 1457 MM, SATINÉ, LOW OUTPUT

4000 K, CRI > 80	3512 lm	2457 lm
2700 K, CRI > 90	2637 lm	1845 lm
3000 K, CRI > 90	2769 lm	1937 lm
4000 K, CRI > 90	2862 lm	2002 lm

*Der angegebene Lichtstrom bezieht sich auf die Leuchte mit klarer mikroprismatischer Abdeckung. Die Leuchte wird mit satinierter Folie zur Erhöhung der Homogenität geliefert (Direkt strahlend: -13,9% , direkt/indirekt strahlend: -6,9% Lichtstrom). Die angegebenen Lichtstromwerte (lm) beziehen sich auf Leuchten mit einem weißen Gehäuse (RAL 9016). Je nach Gehäusefarbe und Länge reduzieren sich diese entsprechend (bezieht sich nur auf U-förmige Abdeckungen). The indicated luminous flux corresponds to the luminaire with a clear microprismatic diffuser. The luminaire is delivered with a satinized-foil for increased homogeneity (direct: -13,9%, direct-indirect: -6,9% luminous flux). All figures of luminous flux (lm) are for fixtures with white housing (RAL 9016). Depending on the housing colour and length, the luminous flux is reduced accordingly. This only applies to U-shaped optics.

1 SIZE

557 mm (non-dim)	055
827 mm	082
1187 mm	118
1457 mm	145

2 COLOUR

silver	9006
white	9016
black	9005
RAL of your choice	

3 LED

2700 K, CRI > 90	927
3000 K, CRI > 90	930
4000 K, CRI > 90	940
4000 K, CRI > 80	840

4 OUTPUT / CONTROL

low output non-dim	L1
low output DALI	L3
high output DALI	H3
high output non dim (557 mm)	H1

5 OPTIC

satiné	S
jet black & light	J
microprism (some versions UGR < 19)	M
U-shaped satiné, 15 mm	U

P30A 1-2 P1 3 4 5

P30A082-9016P1930H3S 827 mm, white, IP44, direct, 3000 K, CRI > 90, high output DALI, satiné (order sample)

► [Configure online on KATALOG.PLANLICHT.COM](#)



Down to UGR ≤ 19 | up to 160 lm/W | up to 2722 lm/m | IEC 62471: Blue light hazard: RG 0 | DALI push switchDIM

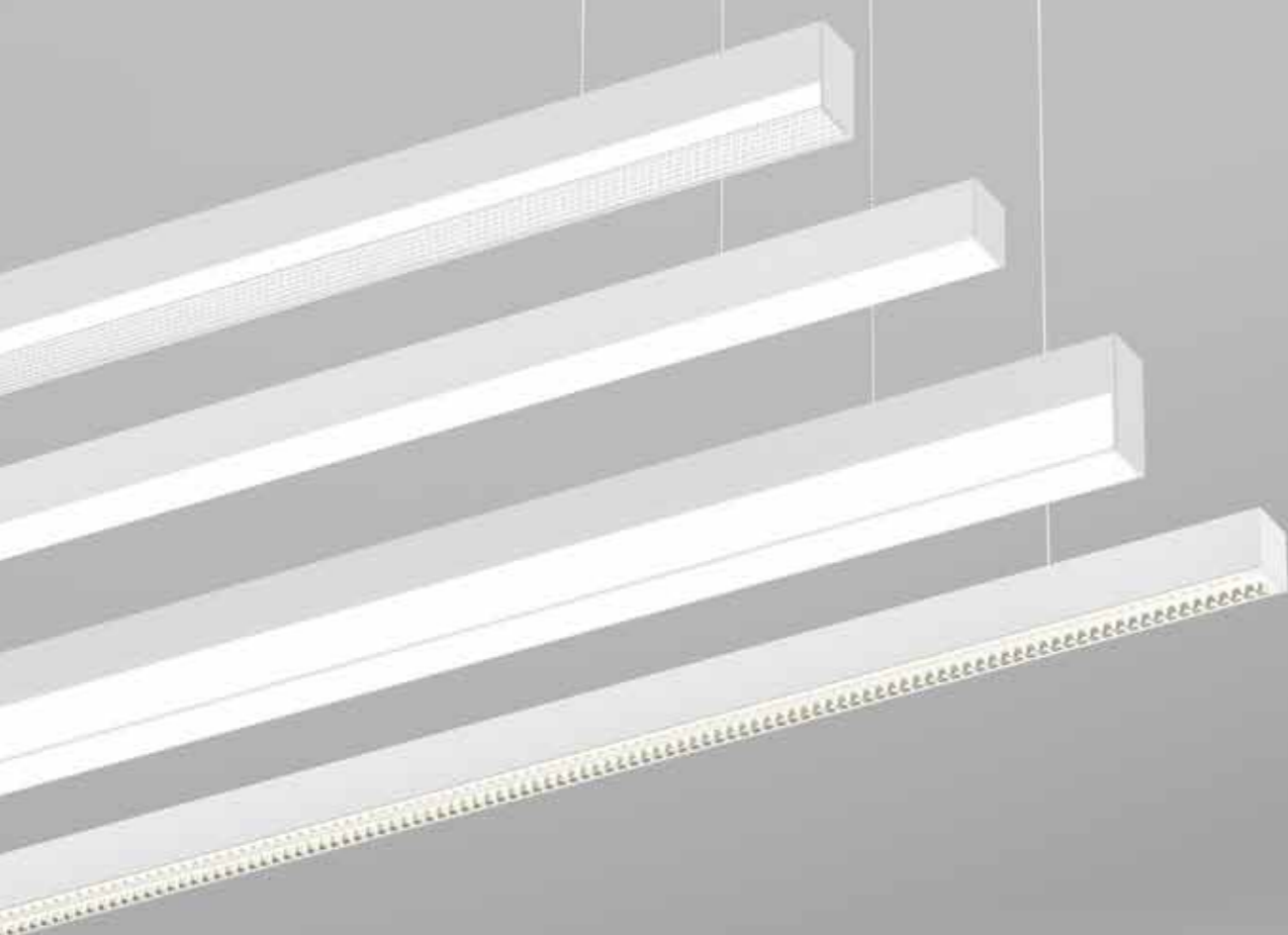

1 SIZE	2 COLOUR	3 DIRECT / INDIRECT
1187 mm	118 black	9005 direct
1457 mm	145 silver	9006 direct/indirect
2899 mm	289 white	9016 RAL of your choice
3531 mm	353 RAL of your choice	
4341 mm	434	
4 LED	5 OUTPUT / CONTROL	6 OPTIC
2700 K, CRI > 90	927 DIFFUSER	satiné
3000 K, CRI > 90	930 low output non-dim	jet black & light
4000 K, CRI > 90	940 low output DALI	microprism*
4000 K, CRI > 80	840 high output DALI	U-shaped satiné, 15 mm
	OBD (Opto-Balance Darklight®)	U-shaped satiné, 34 mm
	high output non dim	U-shaped jet black microprism, 15 mm*
	high output DALI	Opto-Balance Darklight* BAP high-gloss black chrome*
	very high output non-dim (not direct/indirect)	Opto-Balance Darklight* BAP high-gloss copper*
	very high output DALI (not direct/indirect)	Opto-Balance Darklight* BAP high-gloss gold*
		Opto-Balance Darklight* BAP high-gloss silver*
		Opto-Balance Darklight* BAP high-gloss silver*

P30H 1-2 C 3 4 5 6
P30H118-9016C1930H3S pendant, 1187 mm, white, IP20, direct, CRI > 90, 3000K, high output DALI, satiné (order sample) [Configure online on KATALOG.PLANLICHT.COM](#)

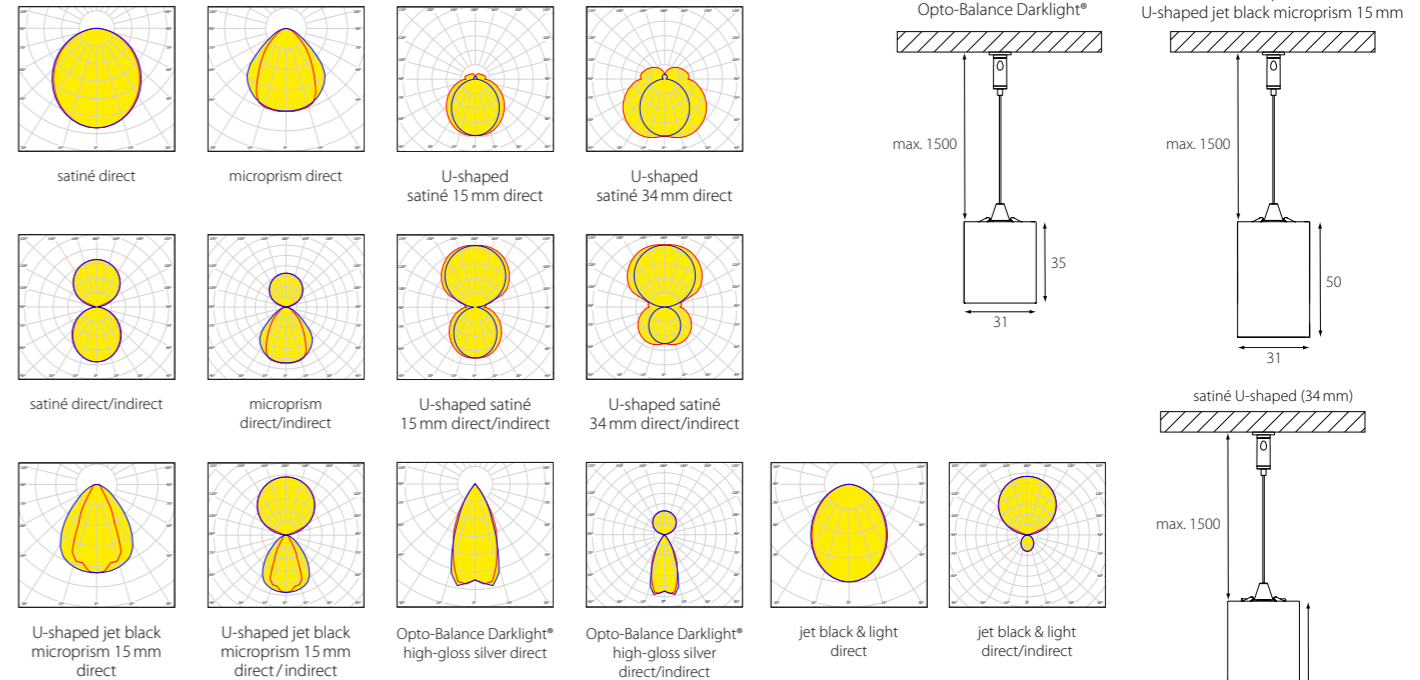

LUMINOUS FLUX (LM) / SYSTEM POWER (W), 4000 K, CRI > 80

4000 K satiné	direct			direct / indirect		weight
	low output	high output	very high output	low output	high output	
1187 mm	1999 lm / 14,5 W	2855 lm / 21 W		3755 lm / 25 W	5329 lm / 36 W	1,1 kg
1457 mm	2457 lm / 17 W	3512 lm / 25 W		4802 lm / 31 W	6818 lm / 44 W	1,3 kg
2899 mm	4895 lm / 34 W	7008 lm / 50 W		9992 lm / 63 W	14200 lm / 91 W	2,5 kg
3531 mm	5961 lm / 43 W	8537 lm / 62 W		12242 lm / 77 W	17398 lm / 112 W	3,0 kg
4341 mm	7331 lm / 51 W	10503 lm / 74 W		14992 lm / 95 W	21315 lm / 137 W	3,7 kg

(based on optic Q)

COMPARE COVER 1457 MM, 4000 K, CRI > 80

cover	direct	indirect
satiné	2457 lm	3512 lm
jet black & light	506 lm	723 lm
microprism*	2534 lm	3624 lm
U-shaped satiné (15 mm)	2588 lm	3710 lm
U-shaped satiné (34 mm)	2724 lm	3903 lm
U-shaped jet black microprism	1419 lm	2020 lm
Opto-Balance Darklight* high-gloss silver	1941 lm	3836 lm
		5102 lm

COMPARE LIGHT COLOUR 1457 MM, SATINÉ, DIRECT, LOW OUTPUT

4000 K, CRI > 80	2457 lm
2700 K, CRI > 90	1845 lm
3000 K, CRI > 90	1937 lm
4000 K, CRI > 90	2002 lm

OPTIONAL ACCESSORY
PROTECTIVE COVER (INDIRECT)
P30-DIF-ID
LED-board cover, optional, reduces lumen output (max. 3,95%), sold by the metre

P.THIRTY PROFILE SYSTEM

*Der angegebene Lichtstrom bezieht sich auf die Leuchte mit klarer mikroprismatischer Abdeckung. Die Leuchte wird mit satinierter Folie zur Erhöhung der Homogenität geliefert (Direkt strahlend: -13,9%, direkt/indirekt strahlend: -6,9% Lichtstrom). Die angegebenen Lichtstromwerte (lm) beziehen sich auf Leuchten mit einem weißen Gehäuse (RAL 9016). Je nach Gehäusefarbe und Länge reduzieren sich diese entsprechend (bezieht sich nur auf U-förmige Abdeckungen). The indicated luminous flux corresponds to the luminaire with a clear microprismatic diffuser. The luminaire is delivered with a satinized foil for increased homogeneity (direct -13,9%, direct/indirect: -6,9% luminous flux). All figures of luminous flux (lm) are for fixtures with white housing (RAL 9016). Depending on the housing colour and length, the luminous flux is reduced accordingly. This only applies to U-shaped optics.

CE UK CA 230V IP20 DALI IEC 62471: Blue light hazard: RG 0 | DALI push switchDIM

p.thirty office special

Hängeleuchte
Pendant luminaire

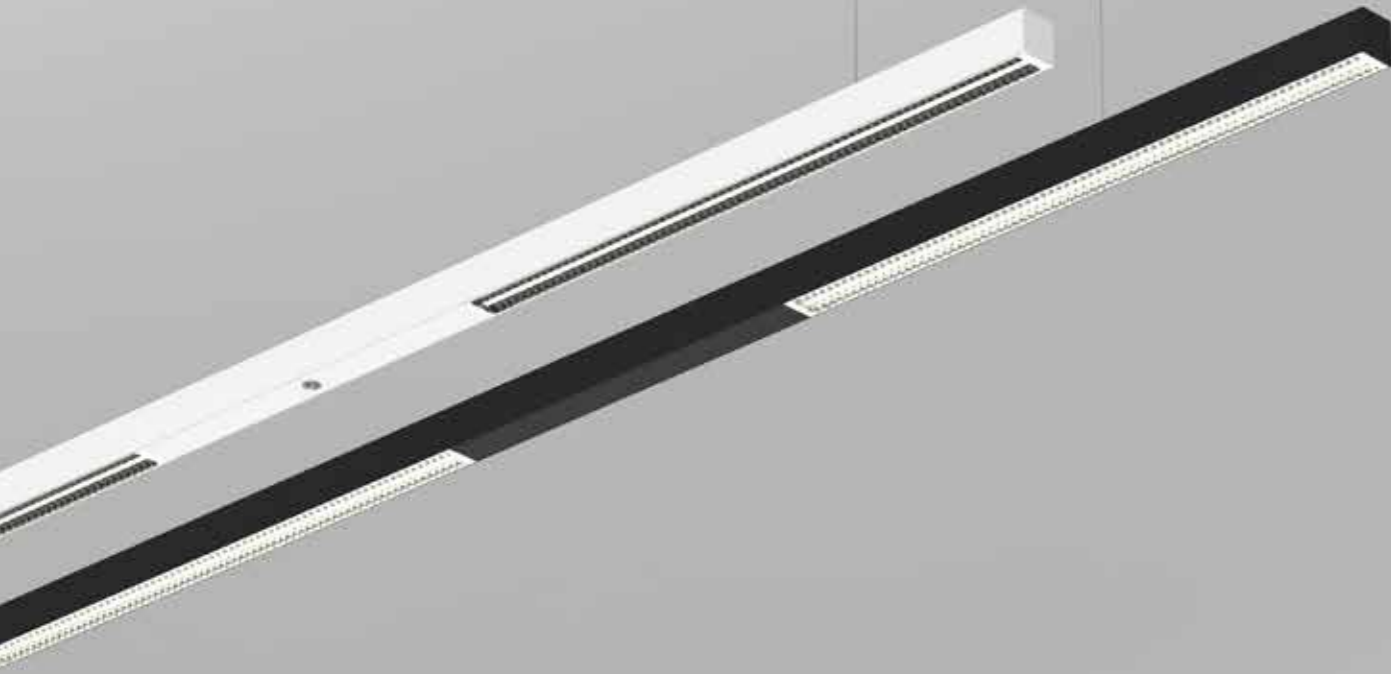

P.THIRTY OFFICE SPECIAL | PENDANT

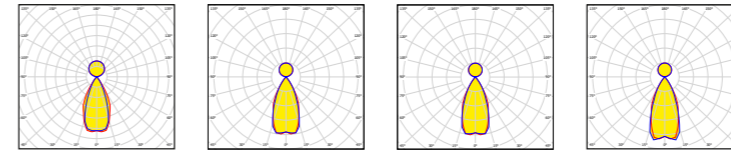

Opto-Balance Darklight® BAP high-gloss black chrome
Opto-Balance Darklight® BAP high-gloss copper
Opto-Balance Darklight® BAP high-gloss gold
Opto-Balance Darklight® BAP high-gloss silver

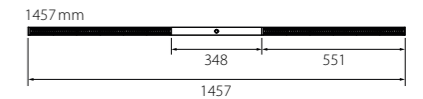
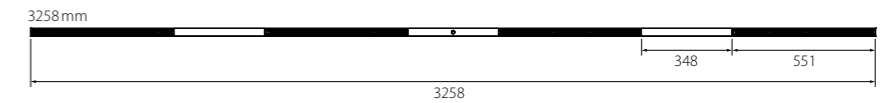
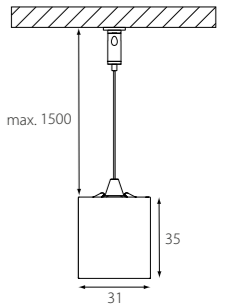

LUMINOUS FLUX (LM) / SYSTEM POWER (W), 4000 K, CRI > 80, HIGH-GLOSS SILVER

Length	very high output	Weight
1457 mm	5565 lm / 52 W	1,7 kg
3258 mm	11130 lm / 104 W	3,4 kg

COMPARE LIGHT COLOUR 1457 MM, 4000 K, CRI > 80, HIGH GLOSS SILVER

4000 K, CRI > 80	5565 lm
2700 K, CRI > 90	4372 lm
3000 K, CRI > 90	4590 lm
4000 K, CRI > 90	4744 lm

COMPARE LOUVRES 1457 MM

Opto-Balance Darklight® BAP high-gloss black chrome	4817 lm
Opto-Balance Darklight® BAP high-gloss copper	5371 lm
Opto-Balance Darklight® BAP high-gloss gold	5407 lm
Opto-Balance Darklight® BAP high-gloss silver	5565 lm

P.THIRTY OFFICE SPECIAL 3258 MM

ideal for table size 3600x900 mm

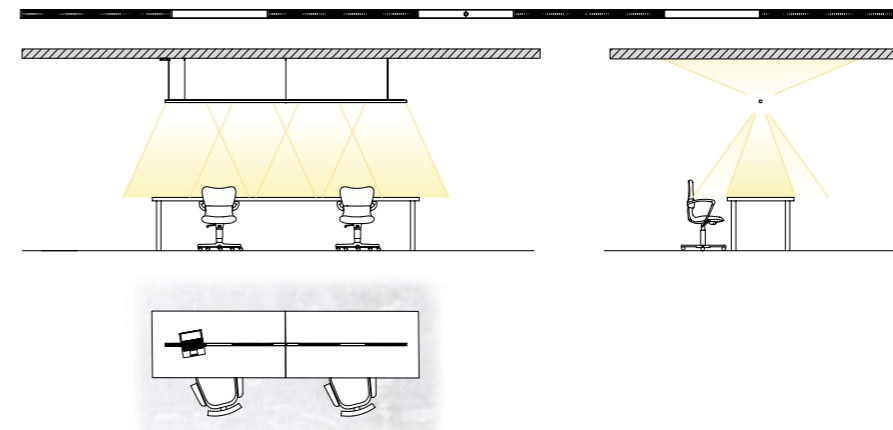

P.THIRTY OFFICE SPECIAL 1457 MM

ideal for table size 1800x900 mm

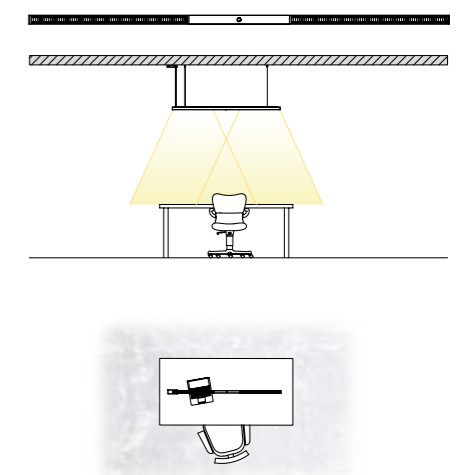

1 SIZE

1457 mm	14X
3258 mm	32X

2 COLOUR

black	9005
silver	9006
white	9016
RAL of your choice	

3 LED

2700 K, CRI > 90	927
3000 K, CRI > 90	930
4000 K, CRI > 90	940
4000 K, CRI > 80	840

4 CONTROL

non-dim	1
DALI	3
Sensor DALI	7

5 OPTIC

Opto-Balance Darklight® BAP high-gloss black chrome*	Z
Opto-Balance Darklight® BAP high-gloss copper*	K
Opto-Balance Darklight® BAP high-gloss gold*	G
Opto-Balance Darklight® BAP high-gloss silver*	B

* UGR-optimised, configure online

P30H 1-2 C2 3 V 4 5

P30H14X-9016C2930V3B 1457 mm, white, IP20, direct & indirect, 3000 K, CRI > 90, very high output, DALI, Opto-Balance Darklight® high-gloss silver (order sample)

► Configure online on KATALOG.PLANLICHT.COM



Down to UGR ≤ 16 | up to 107 lm/m | IEC 62471: Blue light hazard: RG 0 | DALI push switchDIM

sinus p.thirty

Hängeleuchte
Pendant luminaire



SINUS P.THIRTY | PENDANT

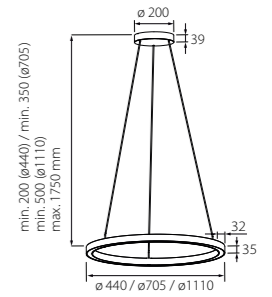
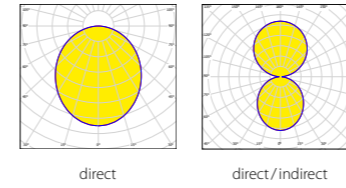

LUMINOUS FLUX (LM) / SYSTEM POWER (W)

4000K satiné	direct		direct/indirect		
	low output	high output	low output	high output	
ø 440 mm	1720lm / 13,5W	2552lm / 21 W	3760 lm / 25W	5584lm / 38W	2,0 kg
ø 705 mm	2772lm / 21 W	4116lm / 32W	6144 lm / 42W	9132lm / 63W	2,7 kg
ø 1110 mm	4464lm / 34W	6624lm / 51 W	9728 lm / 66W	14464 lm / 99W	3,4 kg

COMPARE LIGHT COLOUR Ø 440 MM, 4000 K, CRI > 80, DIRECT, LOW OUTPUT

4000 K, CRI > 80	1720lm
2700 K, CRI > 90	1584lm
3000 K, CRI > 90	1616lm
4000 K, CRI > 90	1704lm

1 SIZE

ø 440 mm	044
ø 705 mm	070
ø 1110 mm	111

2 COLOUR

	silver	9006
	white	9016
	black	9005
	RAL of your choice	

3 DIRECT / INDIRECT

	direct	1
	direct/indirect	2

4 LED

	2700 K, CRI > 90	927
	3000 K, CRI > 90	930
	4000 K, CRI > 90	940
	4000 K, CRI > 80	840

5 OUTPUT / CONTROL

	low output non-dim	L1
	low output DALI	L3
	high output DALI	H3

R30Z 1-2C345S

R30Z070-9016C1927L1S pendant, rope centrally merging, ø 705 mm, white, IP20, direct, 2700 K, CRI > 90, low output, non-dim, satiné (order sample)

► [Configure online on KATALOG.PLANLICHT.COM](#)



Down to UGR ≤ 19 | up to 150lm/W | IEC 62471: Blue light hazard: RG 0 | DALI switchDIM

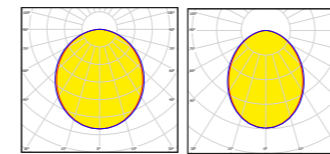
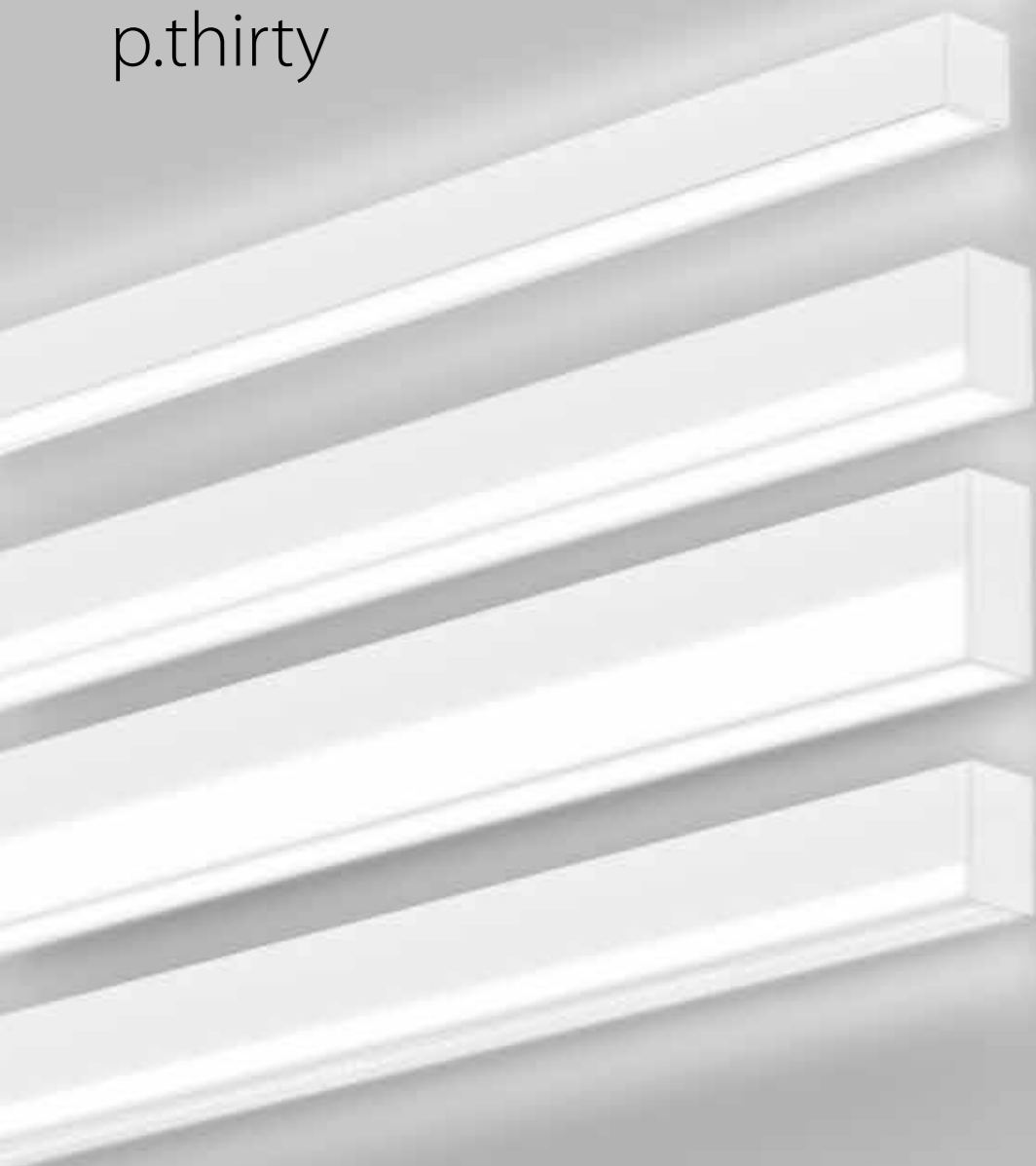

satiné direct jet black & light

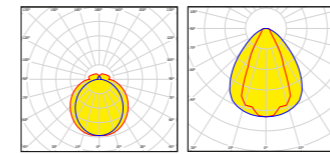

U-shaped satiné 15 mm direct U-shaped jet black microprism (15 mm) direct

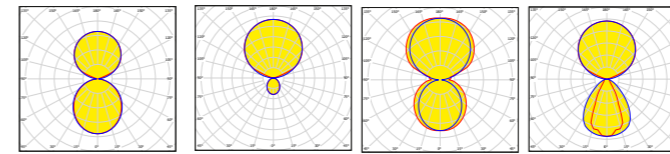

satiné direct/indirect jet black & light direct/indirect U-shaped satiné 15 mm direct/indirect U-shaped jet black microprism (15 mm) direct/indirect

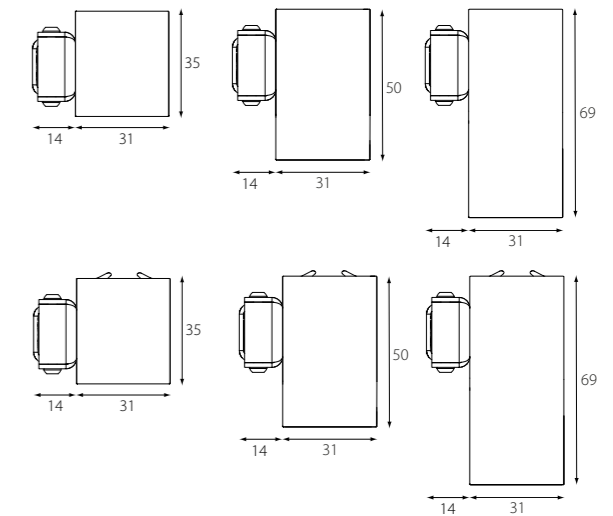

LUMINOUS FLUX (LM)/SYSTEM POWER (W), CRI > 80

4000 K satiné	direct		direct/indirect		KG
	low output	high output	low output	high output	
557 mm	930lm/8W	1324lm/11,5W	1313lm/9,8W	1862lm/14W	0,6 kg
827 mm	1388lm/10,5W	1981lm/15,5W	2359lm/15,5W	3348lm/22W	0,8 kg
1187 mm	1999lm/14,5W	2855lm/21W	3755lm/25W	5329lm/36W	1,1 kg
1457 mm	2457lm/17W	3512lm/25W	4802lm/31W	6818lm/44W	1,3 kg
2899 mm	4895lm/34W	7008lm/50W	9992lm/63W	14200lm/91W	2,5 kg
3531 mm	5961lm/43W	8537lm/62W	12242lm/77W	17398lm/112W	3,0 kg
4341 mm	7331lm/51W	10503lm/74W	14992lm/95W	21315lm/137W	3,7 kg

(based on optic Q)

COMPARE COVER 1457 MM, 4000 K, CRI > 80

satiné	direct		direct/indirect	
	low output	high output	low output	high output
satiné	2457lm	3512lm	4802lm	6818lm
jet black & light	506lm	723lm	3173lm	4483lm
U-shaped satiné (15 mm)	2588lm	3710lm	4933lm	7015lm
U-shaped satiné (34 mm)	2724lm	3903lm	5069lm	7209lm
U-shaped jet black microprism	1419lm	723lm	3764lm	5326lm

COMPARE LIGHT COLOUR 1457 MM, SATINÉ, DIRECT, LOW OUTPUT

4000 K, CRI > 80	2457lm
2700 K, CRI > 90	1845lm
3000 K, CRI > 90	1937lm
4000 K, CRI > 90	2002lm

OPTIONAL ACCESSORY | PROTECTIVE COVER (INDIRECT)

P30-DIF-ID

LED-board cover, optional, reduces lumen output (max. 3,95%), sold by the metre

1 SIZE

- 557 mm (only non-dim)
- 827 mm
- 1187 mm
- 1457 mm
- 2899 mm
- 3531 mm
- 4341 mm

2 COLOUR

- 055** silver
- 082** white
- 118** black
- 145** RAL of your choice
- 289**
- 353**
- 434**

3 DIRECT/INDIRECT

- 1** direct
- 2** direct/indirect

4 LED

- 2700 K, CRI > 90
- 3000 K, CRI > 90
- 4000 K, CRI > 90
- 4000 K, CRI > 80

5 OUTPUT / CONTROL

- 927** low output non-dim
- 930** low output DALI
- 940** high output DALI
- 840** high output non dim (only 057)

6 OPTIC

- S** satiné
- U** U-shaped satiné, 15 mm
- J** jet black & light
- V** U-shaped jet black microprism, 15 mm*

* UGR-optimised, configure online

P30W 1-2-3-4-5-6

P30W082-9016C1930H3S wall, 827 mm, white, IP20, CRI > 90, direct, 3000 K, high output DALI, satiné (order sample)

► Configure online on KATALOG.PLANLICHT.COM



Down to UGR ≤ 16 | up to 167 lm/W | up to 5226 lm/m | IEC 62471: Blue light hazard: RG ≤ 0 | DALI push switchDIM

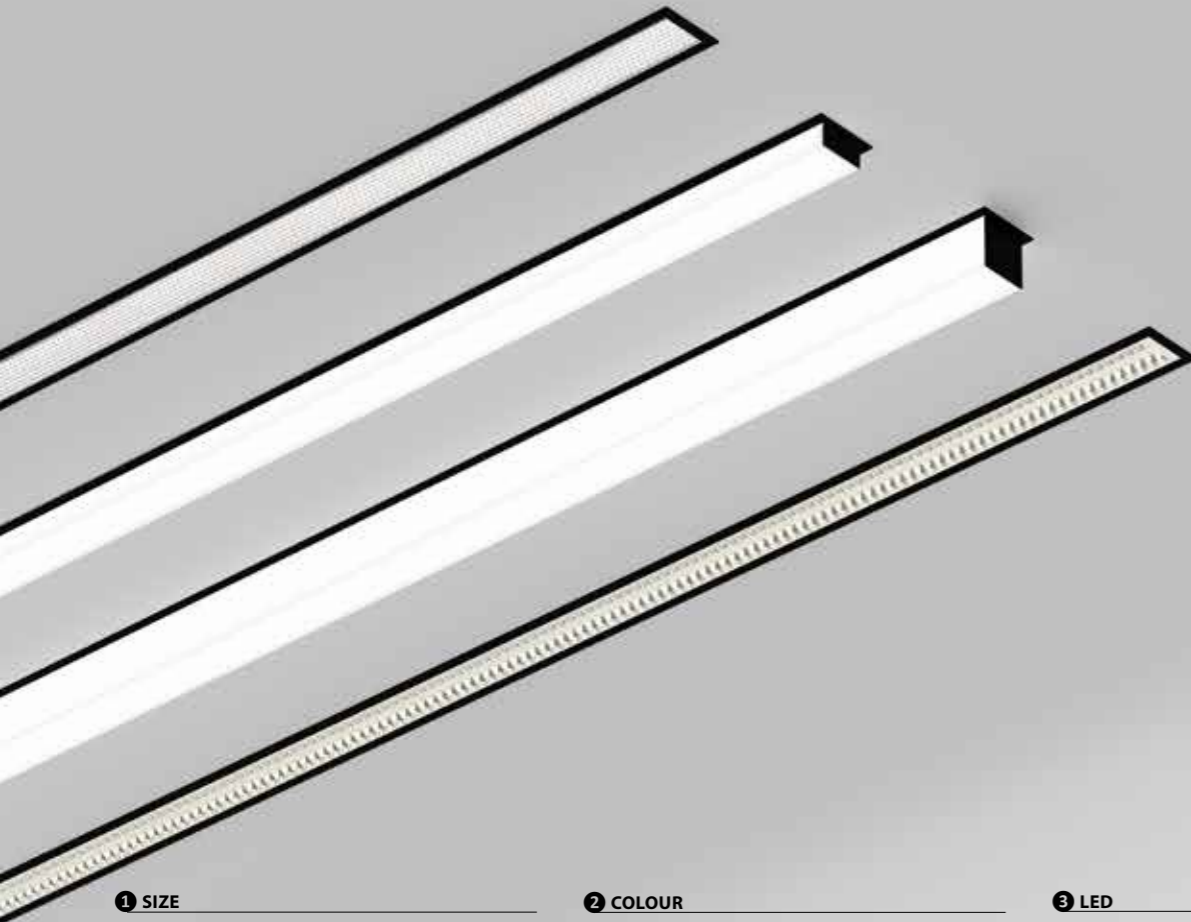

1 SIZE

565 mm (non dim only)	056
835 mm	083
1195 mm	119
1465 mm	146
2907 mm	290
3539 mm	353
4349 mm	434

2 COLOUR

056	silver	9006
083	white	9016
119	black	9005
146	RAL of your choice	9005
290		
353		
434		

3 LED

9006	2700 K, CRI > 90	927
9016	3000 K, CRI > 90	930
9005	4000 K, CRI > 90	940
9005	4000 K, CRI > 80	840

4 OUTPUT / CONTROL

DIFFUSER

low output non-dim	L1
low output DALI	L3
high output non dim (565 mm)	H1
high output DALI	H3

OBD

high output non dim	H1
high output DALI	H3
very high output non-dim (not 835 mm)	V1
very high output DALI (not 835 mm)	V3

5 OPTIC

S	satiné
J	jet black & light
M	microprism*
U	U-shaped satiné, 15 mm
Q	U-shaped satiné, 34 mm
V	U-shaped jet black microprism, 15 mm*
Z	Opto-Balance Darklight® BAP high-gloss black chrome*
K	Opto-Balance Darklight® BAP high-gloss copper*
G	Opto-Balance Darklight® BAP high-gloss gold*
B	Opto-Balance Darklight® BAP high-gloss silver*

* UGR-optimised, configure online

P30E 1-2 C1 3 4 5
P30E353-9016C1930H35 recessed frame, 3539 mm, white, IP20, direct, 3000 K, CRI > 90, high output DALI, satiné (order sample) [Configure online on KATALOG.PLANLICHT.COM](#)

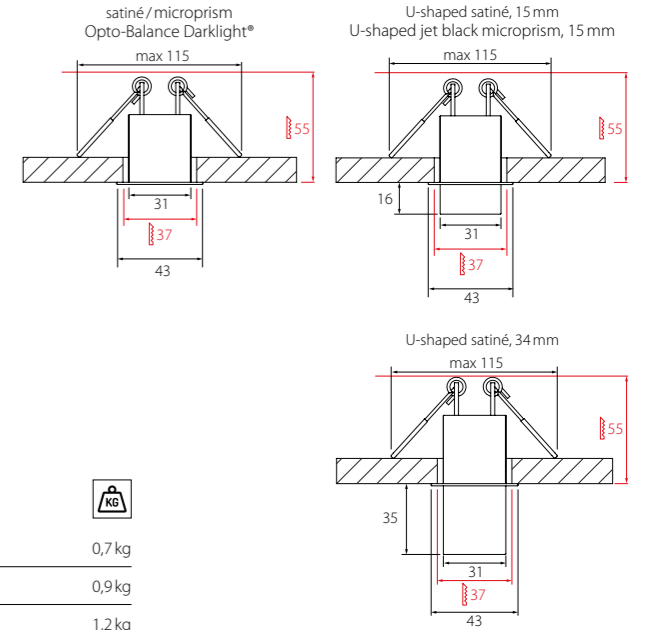
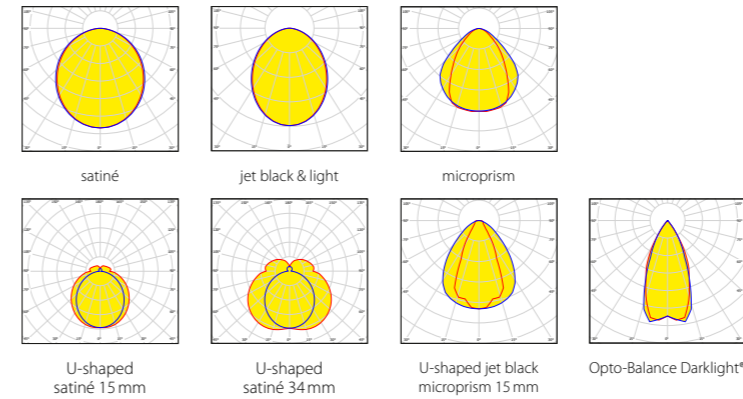

LUMINOUS FLUX (LM) / SYSTEM POWER (W)

4000 K satiné CRI > 80	low output	high output	
557 mm	930 lm / 8W	1324 lm / 11,5W	0,7 kg
827 mm	1388 lm / 10,5W	1981 lm / 15,5W	0,9 kg
1187 mm	1999 lm / 14,5W	2855 lm / 21 W	1,2 kg
1457 mm	2457 lm / 17W	3512 lm / 25W	1,4 kg
2899 mm	4895 lm / 34W	7008 lm / 50W	2,7 kg
3531 mm	5961 lm / 43W	8537 lm / 62W	3,3 kg
4341 mm	7331 lm / 51 W	10503 lm / 74W	4,0 kg

(based on optic Q)

COMPARE COVER 1465 MM, 4000 K, CRI > 80

	low output	high output	very high output
satiné	2457 lm	3512 lm	
jet black & light	506 lm	723 lm	
microprism*	2534 lm	3624 lm	
U-shaped satiné (15 mm)	2588 lm	3710 lm	
U-shaped satiné (34 mm)	2724 lm	3903 lm	
U-shaped jet black microprism (15 mm)	1419 lm	2020 lm	
Opto-Balance Darklight® high-gloss silver		1941 lm	3836 lm

COMPARE LIGHT COLOUR 1465 MM, SATINÉ, LOW OUTPUT

4000 K, CRI > 80	2457 lm
2700 K, CRI > 90	1845 lm
3000 K, CRI > 90	1937 lm
4000 K, CRI > 90	2002 lm

*Der angegebene Lichtstrom bezieht sich auf die Leuchte mit klarer mikrop Prismatischer Abdeckung. Die Leuchte wird mit satinierter Folie zur Erhöhung der Homogenität geliefert (Direkt strahlend: -13,9% , direkt/indirekt strahlend: -6,9% Lichtstrom). Die angegebenen Lichtstromwerte (lm) beziehen sich auf Leuchten mit einem weißen Gehäuse (RAL 9016). Je nach Gehäusefarbe und Länge reduzieren sich diese entsprechend (bezieht sich nur auf U-förmige Abdeckungen).
The indicated luminous flux corresponds to the luminaire with a clear microp rismatic diffuser. The luminaire is delivered with a satinized foil for increased homogeneity (direct: -13,9%, direct-indirect: -6,9% luminous flux). All figures of luminous flux (lm) are for fixtures with white housing (RAL 9016). Depending on the housing colour and length, the luminous flux is reduced accordingly. This only applies to U-shaped optics.

P.THIRTY PROFILE SYSTEM



Down to UGR ≤ 16 | up to 160 lm/W | up to 3013 lm/m | IEC 62471: Blue light hazard: RG 0 | push switchDIM

p.thirty IP 44

Einbauleuchte
Recessed luminaire

P.THIRTY IP 44 | RECESSED

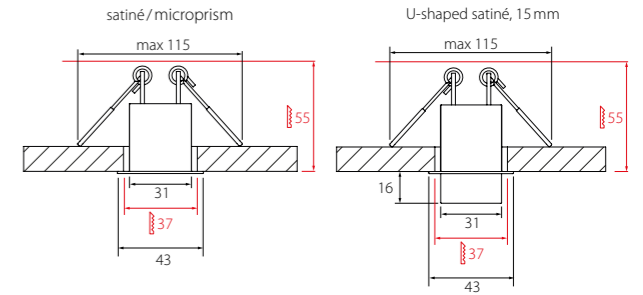
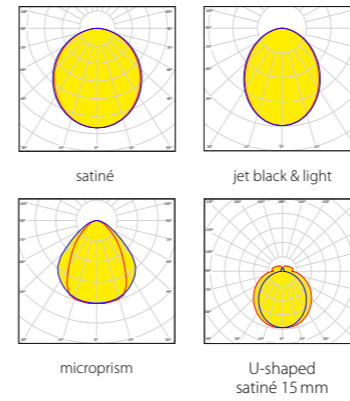
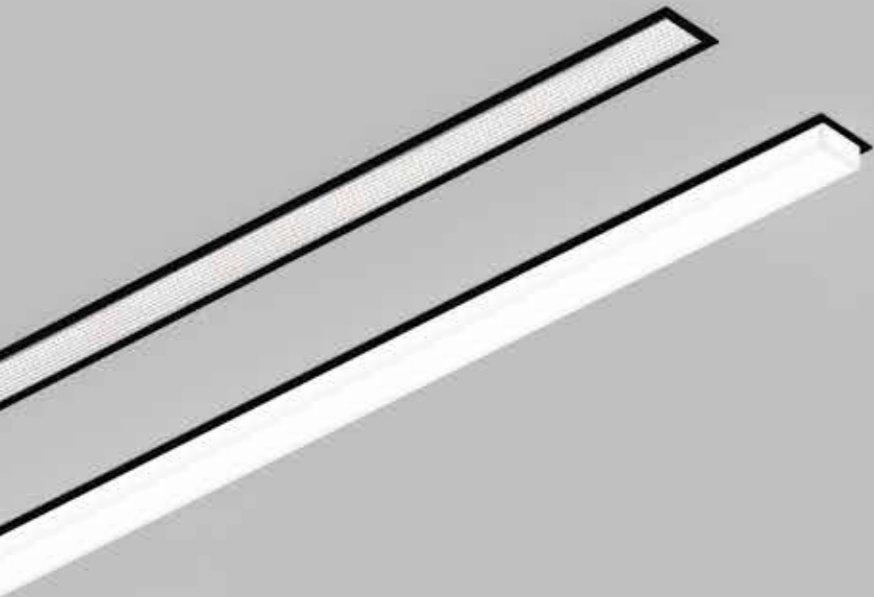

LUMINOUS FLUX (LM) / SYSTEM POWER (W)

4000 K satiné CRI > 80	low output	high output	
557 mm	930lm/8W	1324lm/11,5W	0,7kg
827 mm	1388lm/10,5W	1981lm/15,5W	0,9kg
1187 mm	1999lm/14,5W	2855lm/21W	1,2kg
1457 mm	2457lm/17W	3512lm/25W	1,4kg

(based on optic Q)

COMPARE COVER 1465 MM, 4000 K, CRI > 80

	low output	high output
satiné	2457lm	3512lm
jet black & light	506lm	723lm
microprism*	2534lm	3624lm
U-shaped satined (15 mm)	2588lm	3710lm

COMPARE LIGHT COLOUR 1465 MM, SATINÉ, LOW OUTPUT

4000 K, CRI > 80	2457lm
2700 K, CRI > 90	1845lm
3000 K, CRI > 90	1937lm
4000 K, CRI > 90	2002lm

*Der angegebene Lichtstrom bezieht sich auf die Leuchte mit klarer mikroprismatischer Abdeckung. Die Leuchte wird mit satiniertes Folie zur Erhöhung der Homogenität geliefert (Direkt strahlend: -13,9%, direkt/indirekt strahlend: -6,9% Lichtstrom). Die angegebenen Lichtstromwerte (lm) beziehen sich auf Leuchten mit einem weißen Gehäuse (RAL 9016). Je nach Gehäusefarbe und Länge reduzieren sich diese entsprechend (bezieht sich nur auf U-förmige Abdeckungen).

The indicated luminous flux corresponds to the luminaire with a clear microprismatic diffuser. The luminaire is delivered with a satined-foil for increased homogeneity (direct: -13,9%, direct-indirect: -6,9% luminous flux). All figures of luminous flux (lm) are for fixtures with white housing (RAL 9016). Depending on the housing colour and length, the luminous flux is reduced accordingly. This only applies to U-shaped optics.

1 SIZE

565 mm (non dim only)	056
835 mm	083
1195 mm	119
1465 mm	146

2 COLOUR

	silver	9006
	white	9016
	black	9005
	RAL of your choice	

3 LED

	2700 K, CRI > 90	927
	3000 K, CRI > 90	930
	4000 K, CRI > 90	940
	4000 K, CRI > 80	840

4 OUTPUT / CONTROL

DIFFUSER

	low output non-dim	L1
	low output DALI	L3
	high output non dim (565 mm)	H1
	high output DALI	H3

5 OPTIC

	satiné	S
	jet black & light	J
	microprism*	M
	U-shaped satiné, 15 mm	U

* UGR-optimised, configure online

P30E1-2P1345

P30E146-9016P1930H3S recessed frame, 1465 mm, white, IP44, direct, 3000 K, CRI > 90, high output DALI, satiné (order sample)

► Configure online on KATALOG.PLANLICHT.COM



Down to UGR ≤ 19 | up to 160lm/W | up to 2722lm/m | IEC 62471: Blue light hazard: RG 0 | push switchDIM



1 TYPE

- Floor lamp **T**
- Table lamp **D**

2 BASE & MOUNTING TYPE

- FLOOR LAMP**
- U form **U**
- T form **T**
- TABLE LAMP**
- Table clamp **K**
- Direct connection (through table) **A**

3 COLOUR

- silver
- white
- black
- RAL of your choice

4 CONNECTION TYPE

- SI** Schuko plug-Type F (EU) **E**
- WS** Swiss plug-Type J (CH) **C**
- SW** British plug-Type G (UK) **U**
- Cable transparent without plug **D**

5 CONTROL ELEMENT

- Touch panel **P**
- No integrated control (only cable without plug) **X**

6 DIRECT / INDIRECT

- direct **P**
- direct/indirect **X**

7 LED

- 1** 3000 K, CRI > 90 **930**
- 2** 4000 K, CRI > 90 **940**
- 2700 - 6500 K, dynamic white, CRI > 90 **HCL**

8 OUTPUT

- low output
- high output
- dynamic white

9 CONTROL

- L** DALI dim (1 Ckt.)
- H** DALI dim (2 Ckt.)
- X** Sensor DALI (2 Ckt.)
- Sensor DALI (1 Ckt.)

10 OPTIC

- 3** **OBA (Opto-Balance Asymmetric)**
- 4** silver matte **P**
- 5** silver semi-matte / high gloss **3**
- 7** gold semi-matte / high gloss **2**
- copper semi-matte / high gloss **4**
- black chrome semi-matte / high gloss **1**

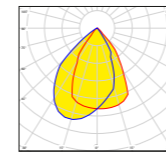

direct

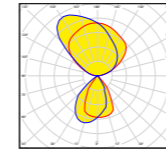

direct/indirect

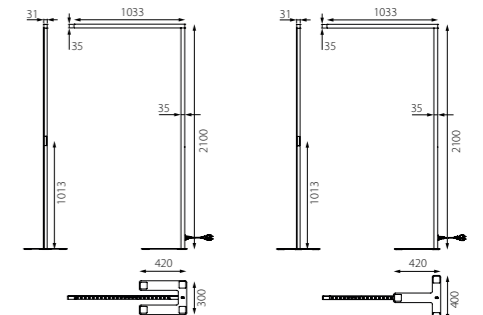

FLOOR LAMP
U form
7,4 kg

FLOOR LAMP
T form
6,5 kg

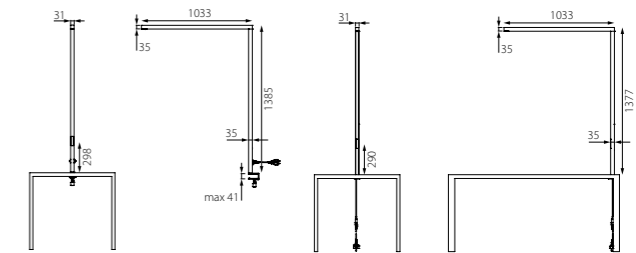

TABLE LAMP
Table clamp
3,5 kg

TABLE LAMP
Direct connection
3,4 kg

LUMINOUS FLUX (LM) / SYSTEM POWER (W), 4000 K, CRI > 90

	direct			direct / indirect		
	low output	high output	dynamic white	low output	high output	dynamic white
silver matte	2215 lm / 17W	3159 lm / 25W	2976 lm / 25W	8580 lm / 57W	12025 lm / 84W	11330 lm / 85W
silver semi-matte	2594 lm / 17W	3699 lm / 25W	3485 lm / 25W	8959 lm / 57W	12565 lm / 84W	11839 lm / 85W
gold semi-matte	2406 lm / 17W	3430 lm / 25W	3232 lm / 25W	8771 lm / 57W	12296 lm / 84W	11586 lm / 85W
copper semi-matte	2364 lm / 17W	3372 lm / 25W	3177 lm / 25W	8729 lm / 57W	12238 lm / 84W	11531 lm / 85W
black chrome semi-matte	2016 lm / 17W	2875 lm / 25W	2709 lm / 25W	8381 lm / 57W	11741 lm / 84W	11063 lm / 85W

COMPARE LIGHT COLOUR SILVER MATTE, CRI > 90

LF940 4000 K	3159 lm
LF930 3000 K	3015 lm
LF927 2700 K	2976 lm

LOUVRE COLOURS



T30 1 1M 2 - 3 4 5 C 6 7 8 9 10

T30T1MU-SIEPC2930H4P Floor lamp, U-base, silver, Schuko plug-Type F (EU), Touch panel, direct/indirect, 3000 K, CRI > 90, high output, DALI dim (2 Ckt.), silver matte (order sample)

► [Configure online on KATALOG.PLANLICHT.COM](https://www.katalog.planlicht.com)



up to 156lm/W | IEC 62471: Blue light hazard: RG 0 | DALI DIM

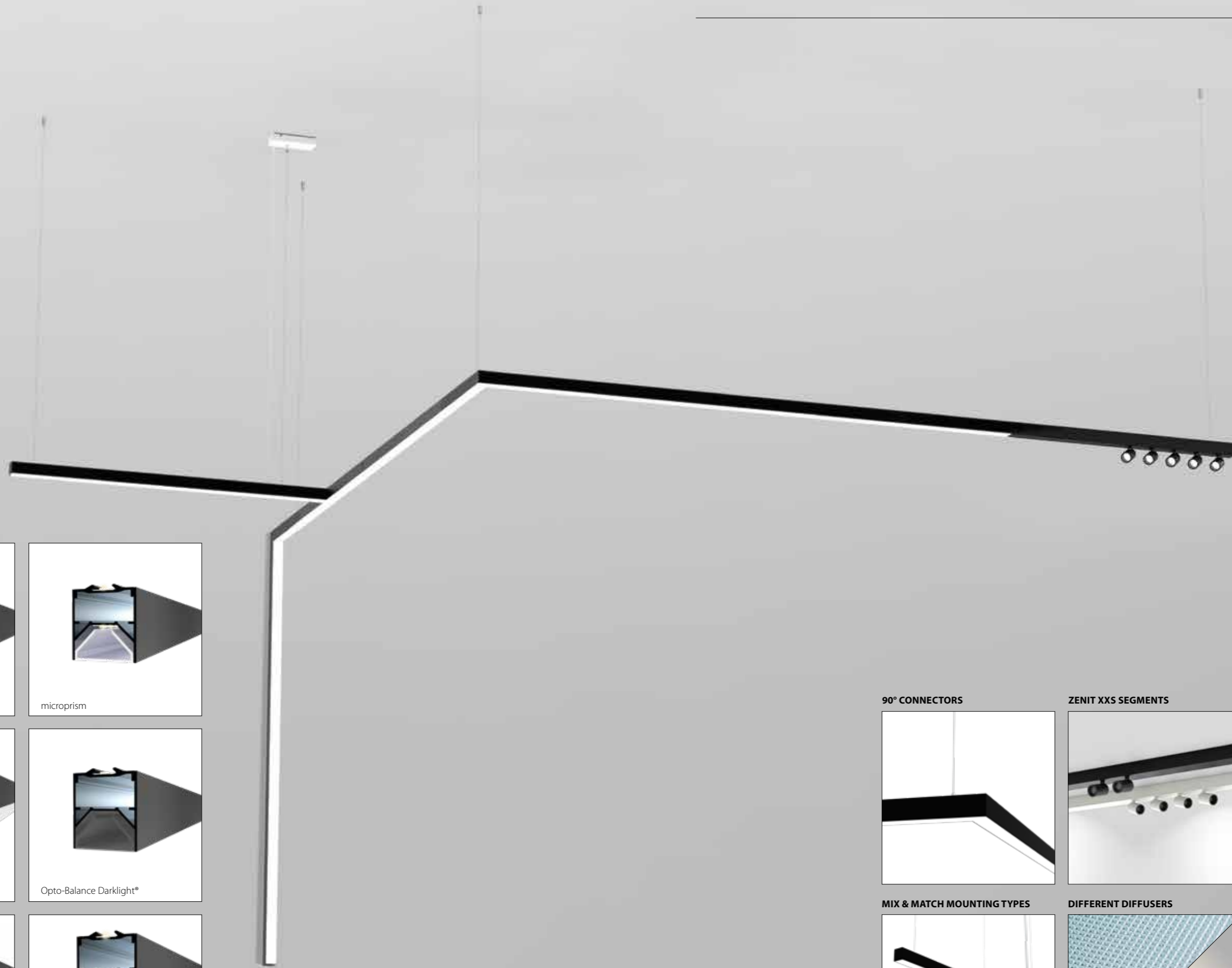

DIFFERENT SHAPES / DIFFUSERS



satiné

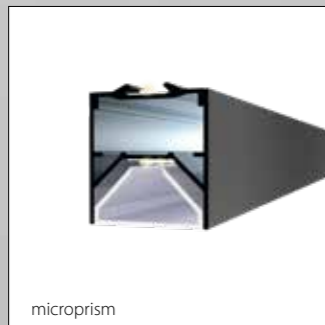

microprism

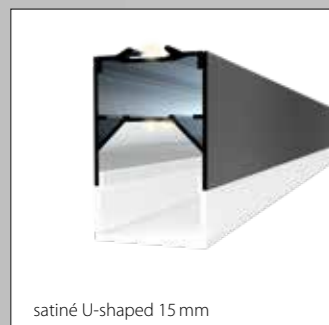

satiné U-shaped 15 mm



Opto-Balance Darklight®

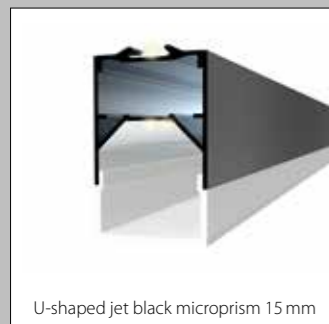

U-shaped jet black microprism 15 mm

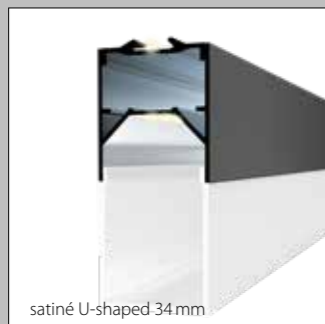

satiné U-shaped 34 mm

90° CONNECTORS

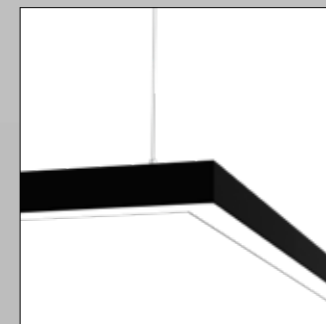

ZENIT XXS SEGMENTS



DIFFERENT HOUSING COLOURS

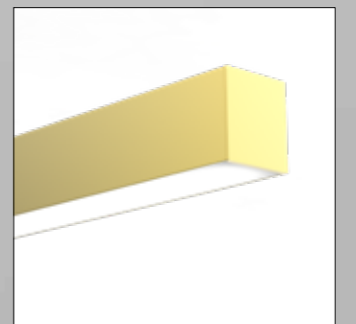

MIX & MATCH MOUNTING TYPES

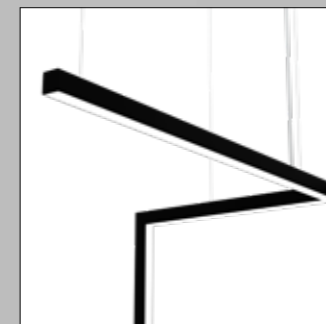

DIFFERENT DIFFUSERS

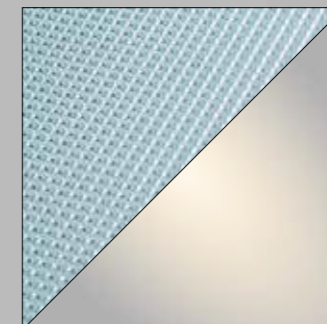

DIFFERENT COLOUR CABLES

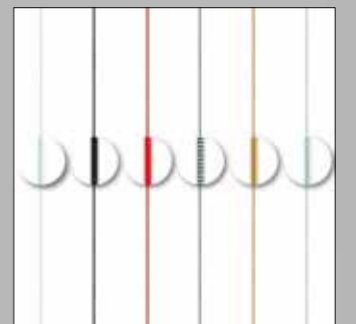

1 MOUNTING

- Surface mounted
- Pendant
- Wall mounted
- Recessed

4 DIRECT/INDIRECT

- direct
- direct/indirect

5 LED

- LF927 2700K, CRI > 90
- LF930 3000K, CRI > 90
- LF940 4000K, CRI > 90
- LF840 4000K, CRI > 80

6 OUTPUT/CONTROL

- low output non-dim (not OBD)
- low output DALI (not OBD)
- high output non-dim (recessed with diffuser 054 & 063 only)
- high output DALI
- very high output non-dim (direct/OBD only)
- very high output DALI (direct/OBD only)

7 OPTIC

- satiné
- jet black & light
- microprism*
- U-shaped satiné, 15 mm
- U-shaped satiné, 34 mm
- U-shaped jet black microprism, 15 mm*
- Opto-Balance Darklight® BAP high-gloss black chrome*
- Opto-Balance Darklight® BAP high-gloss copper*
- Opto-Balance Darklight® BAP high-gloss gold*
- Opto-Balance Darklight® BAP high-gloss silver*

* UGR-optimised, configure online

A
H
W
E

3 COLOUR

- silver **9006**
- white **9016**
- black **9005**
- RAL of your choice

2 FORM/SIZE

927	Segment L-Form, horizontal 643 x 293 mm	LFH	Linear segment 2254 mm	225
930	Segment L-Form, vertical (not H, OBD) 560 x 199 mm	LFV	Linear segment 2344 mm	234
940	Segment T-Form, horizontal (not W) 722 x 213 mm	TFH	Linear segment 2434 mm	243
840	Segment X-Form, horizontal (not W) 722 x 215 mm	XFH	Linear segment 2524 mm	252
L1	Linear segment 542 mm (only L1, direct, recessed H1)	054	Linear segment 2614 mm	261
L3	Linear segment 632 mm (only L1, direct, recessed H1)	063	Linear segment 2704 mm	270
H1	Linear segment 722 mm	072	Linear segment 2794 mm	279
H3	Linear segment 812 mm (not very high output)	081	Linear segment 2884 mm	288
V1	Linear segment 902 mm (not very high output)	090	Linear segment 2974 mm	297
V3	Linear segment 992 mm (not di/id, very high output)	099	Linear segment 3064 mm	306
S	Linear segment 1082 mm (not di/id, very high output)	108	Linear segment 3156 mm	315
J	Linear segment 1172 mm (not di/id, very high output)	117	Linear segment 3246 mm	324
M	Linear segment 1262 mm	126	Linear segment 3336 mm	333
U	Linear segment 1352 mm	135	Linear segment 3426 mm	342
Q	Linear segment 1442 mm	144	Linear segment 3516 mm	351
V	Linear segment 1532 mm	153	Linear segment 3606 mm	360
Z	Linear segment 1624 mm	162	Linear segment 3696 mm	369
K	Linear segment 1714 mm	171	Linear segment 3786 mm	378
G	Linear segment 1804 mm	180	Linear segment 3876 mm	387
B	Linear segment 1894 mm	189	Linear segment 3966 mm	396
	Linear segment 1984 mm	198	Linear segment 4056 mm	405
	Linear segment 2074 mm	207	Linear segment 4146 mm	414
	Linear segment 2164 mm	216	Linear segment 4236 mm	423
			Linear segment 4326 mm	432

LUMINOUS FLUX (LM) / SYSTEM POWER (W), CRI > 80

4000 K satiné	low output	direct		direct/indirect	
		high output	very high output	low output	high output
542 mm	930 lm / 8W	-	-	-	-
632 mm	1082 lm / 8,9W	-	-	-	-
722 mm	1236 lm / 9,8W	1762 lm / 14W		2010 lm / 13,5W	2853 lm / 19,5W
812 mm	1388 lm / 10,5W	1981 lm / 15,5W		2359 lm / 15,5W	3348 lm / 22W
902 mm	1541 lm / 11,5W	2199 lm / 16,5W		2708 lm / 17W	3843 lm / 25W
1262 mm	2151 lm / 15,5W	3074 lm / 22W		4103 lm / 27W	5825 lm / 39W
1442 mm	2457 lm / 17W	3512 lm / 25W		4802 lm / 31W	6818 lm / 44W
1714 mm	2914 lm / 22W	4167 lm / 32W		5848 lm / 36W	8304 lm / 52W
2254 mm	3829 lm / 28W	5479 lm / 40W		7352 lm / 49W	10449 lm / 71W
3064 mm	5201 lm / 36W	7445 lm / 52W		10692 lm / 67W	15193 lm / 97W
3606 mm	6113 lm / 44W	8755 lm / 64W		12788 lm / 80W	18174 lm / 116W
4326 mm	7331 lm / 51W	10503 lm / 74W		14992 lm / 95W	21315 lm / 137W
LFH	1541 lm / 11,5W	2199 lm / 16,5W		2708 lm / 17W	3843 lm / 25W
LFV	1236 lm / 9,8W	1762 lm / 14W		2206 lm / 14,5W	3129 lm / 21W
TFH	1541 lm / 11,5W	2199 lm / 16,5W		2708 lm / 17W	3843 lm / 25W
XFH	1541 lm / 11,5W	2199 lm / 16,5W		2905 lm / 17W	4119 lm / 26W

COMPARE COVER 1442 MM, 4000 K, CRI > 80

cover type	low output	high output	very high output	low output	high output
satiné	2457 lm	3512 lm		4802 lm	6818 lm
microprism	2533 lm	3625 lm		4879 lm	6927 lm
U-shaped satiné (15 mm)	2587 lm	3708 lm		4932 lm	7015 lm
U-shaped satiné (34 mm)	2724 lm	3902 lm		5070 lm	7207 lm
U-shaped jet black microprism	1417 lm	2020 lm		3765 lm	5324 lm
jet black & light	506 lm	723 lm		2851 lm	4029 lm
Opto-Balance Darklight® high-gloss silver	-	1941 lm	3836 lm		5102 lm

COMPARE LIGHT COLOUR, SATINÉ, LOW OUTPUT

light colour	low output
4000 K, CRI > 80	2457 lm
2700 K, CRI > 90	1846 lm
3000 K, CRI > 90	1936 lm
4000 K, CRI > 90	2002 lm

OPTIONAL ACCESSORY

PROTECTIVE COVER (INDIRECT)

P30-DIF-ID

LED-board cover, optional, reduces lumen output (max. 3,95%), sold by the metre



Down to UGR ≤ 16 | up to 171 lm/W | up to 5262 lm/m | IEC 62471: Blue light hazard: RG 0 | DALI push switchDIM

PENDANT | WALL | SURFACE

01 PROFILE HOUSING

- P30-PRO1-9006
- P30-PRO1-9016
- P30-PRO1-9005

PENDANT | WALL | SURFACE

02 END CAP

- P30-END-B-9006
- P30-END-B-9016
- P30-END-B-9005

RECESSED

27 END CAP

- P30-ENDE-B-9006
- P30-ENDE-B-9016
- P30-ENDE-B-9005

30 PROFILE HOUSING

- P30-PROE-9006
- P30-PROE-9016
- P30-PROE-9005

03 END CAP

- P30-END-BU-9006
- P30-END-BU-9016
- P30-END-BU-9005

28 END CAP

- P30-ENDE-BU-9006
- P30-ENDE-BU-9016
- P30-ENDE-BU-9005

04 END CAP

- P30-END-BQ-9006
- P30-END-BQ-9016
- P30-END-BQ-9005

29 END CAP

- P30-ENDE-BQ-9006
- P30-ENDE-BQ-9016
- P30-ENDE-BQ-9005

OPTIC

- P30-DIF-S (satiné)
- P30-DIF-J jet black & light
- P30-DIF-M (microprism)
- P30-DIF-SU U-shaped satiné (15 mm)
- P30-DIF-SQ U-shaped satiné (34 mm)
- P30-DIF-JU jet black microprism (15 mm)
- P30-OBD-Z Opto-Balance Darklight® BAP high-gloss black chrome
- P30-OBD-K Opto-Balance Darklight® BAP high-gloss copper
- P30-OBD-G Opto-Balance Darklight® BAP high-gloss gold
- P30-OBD-B Opto-Balance Darklight® BAP high-gloss silver

Meterware; Maximale Länge: 4500 mm
Sold by the metre; maximum length: 4500 m

09 BLANK COVER (DIRECT)

- P30-BLI-9006
- P30-BLI-9016
- P30-BLI-9005

Meterware
Sold by the metre

10 BLANK COVER (INDIRECT)

- P30-BLI2-9006
- P30-BLI2-9016
- P30-BLI2-9005
- P30-BLI2-ALU

Meterware
Sold by the metre

11 BLANK COVER U-SHAPED (15 MM)

- P30-BLU-9006
- P30-BLU-9016
- P30-BLU-9005

Meterware
Sold by the metre

12 BLANK COVER U-SHAPED (34 MM)

- P30-BLQ-9006
- P30-BLQ-9016
- P30-BLQ-9005

Meterware
Sold by the metre

14 WALL MOUNTING BRACKET

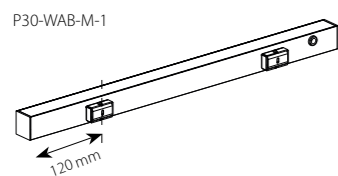

15 POWER SUPPLY WITH CANOPY

- P30-EIN-3 0,75 mm² 3-pole
- P30-EIN-5 0,75 mm² 5-pole

1750mm

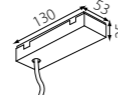

16 SUSPENSION CABLE WITH RAPID TENSIONER

- P30-SEI-150 1500 mm
- P30-SEI-600 6000 mm

17 SEGMENT CONNECTOR

P30-LIN

18 FEED-THROUGH WIRING FOR BLANK COVER

P30-DV-BLI
Meterware
Sold by the metre

19 CABLE SET

P30-DVS
5-polig für Dimmung
5-pole for dimming

20 POWER SUPPLY WITH CANOPY

- P30-EIN-BLACK 0,75 mm² 5-pole
 - P30-EIN-GOLD 0,75 mm² 5-pole
 - P30-EIN-IRON 0,75 mm² 5-pole
 - P30-EIN-RED 0,75 mm² 5-pole
 - P30-EIN-SILVER 0,75 mm² 5-pole
 - P30-EIN-WHITE 0,75 mm² 5-pole
- 1750 mm
- P30-EIN-BLACK-6M 0,75 mm² 5-pole
 - P30-EIN-GOLD-6M 0,75 mm² 5-pole
 - P30-EIN-RED-6M 0,75 mm² 5-pole
 - P30-EIN-SILVER-6M 0,75 mm² 5-pole
 - P30-EIN-WHITE-6M 0,75 mm² 5-pole
- 6000 mm

21 L-CONNECTOR HORIZONTAL

Configure on page 34

22 L-CONNECTOR VERTICAL

Configure on page 34

23 T-CONNECTOR

Configure on page 34

24 X-CONNECTOR

Configure on page 34

31 ID-LED-COVER

- P30-DIF-ID
- LED-Panelabdeckung, optional, reduziert Lichtleistung, Meterware
LED-board cover, optional, reduces lumen output, sold by the metre

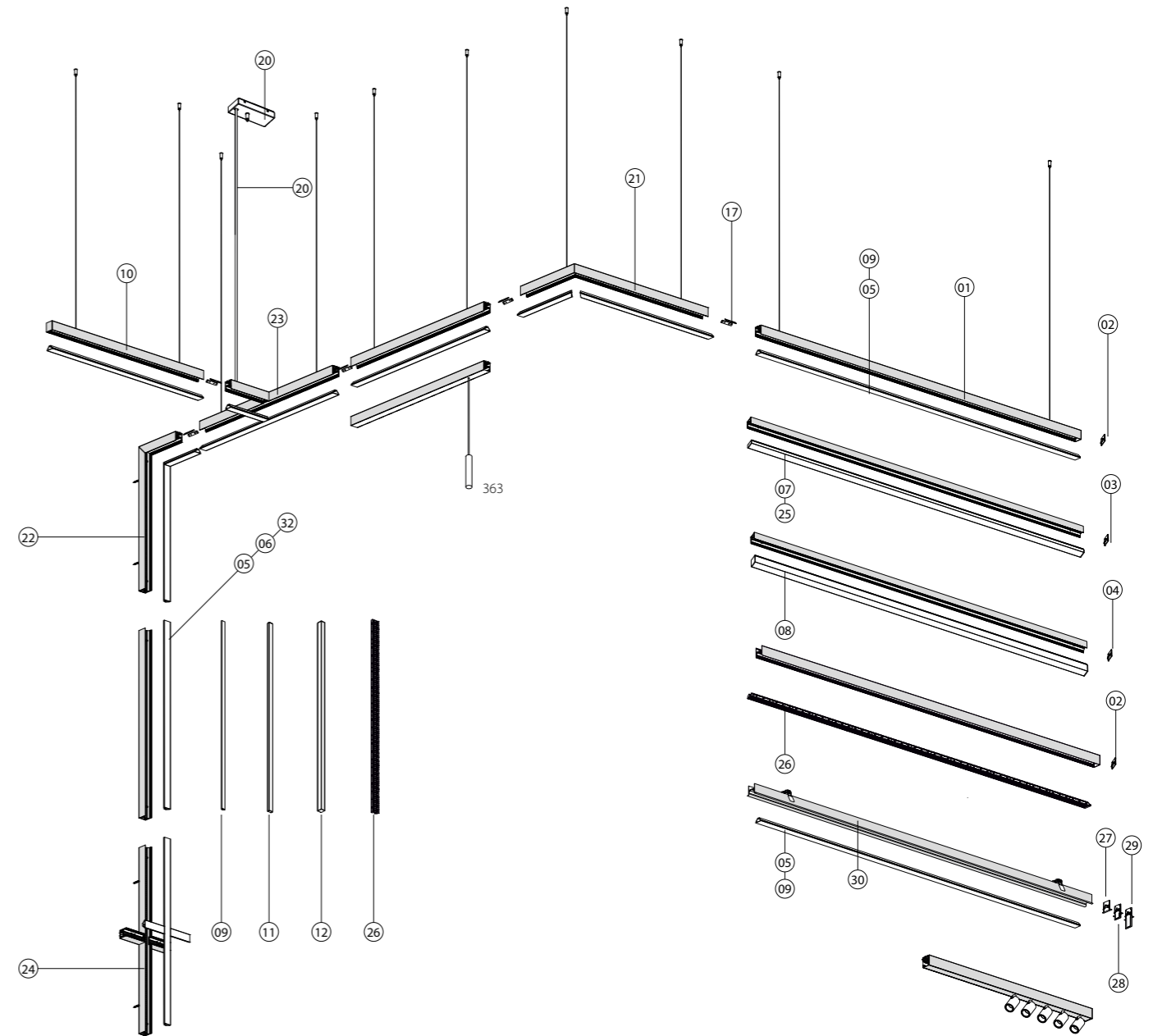

zenit XXS segment spots for p.thirty

Systeme | Segmente
Systems | Segments

ZENIT XXS | SYSTEMS

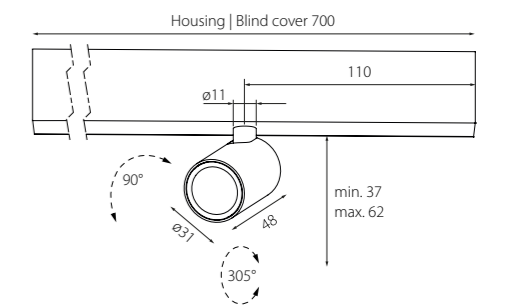
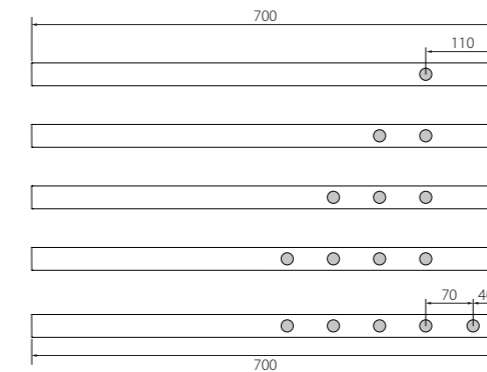
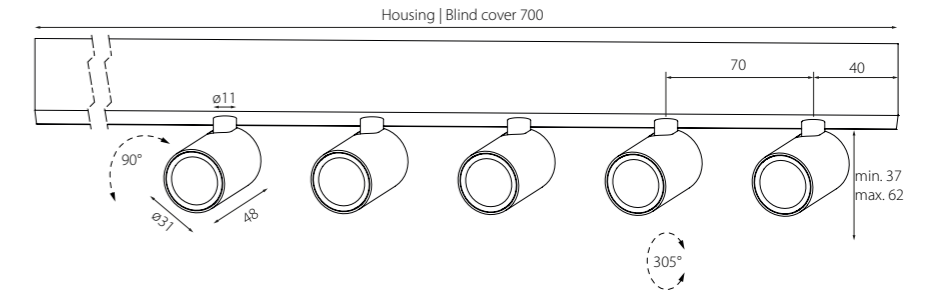
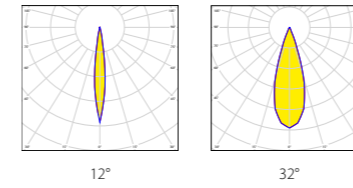

LUMINOUS FLUX (LM) / SYSTEM POWER (W)

	12°					32°				
	1 spot (7W)	2 spots (11,5W)	3 spots (16,5W)	4 spots (21W)	5 spots (26W)	1 spot (7W)	2 spots (11,5W)	3 spots (16,5W)	4 spots (21W)	5 spots (26W)
LF927 2700 K	183 lm	366 lm	549 lm	732 lm	915 lm	272 lm	544 lm	816 lm	1088 lm	1360 lm
LF930 3000 K	189 lm	378 lm	567 lm	756 lm	945 lm	280 lm	560 lm	840 lm	1120 lm	1400 lm
LF940 4000 K	197 lm	394 lm	591 lm	788 lm	985 lm	292 lm	584 lm	876 lm	1168 lm	1460 lm

WEIGHT

1 spot	0,7 kg
2 spots	0,8 kg
3 spots	0,9 kg
4 spots	0,9 kg
5 spots	1,0 kg

Basierend auf der Einbauversion | based on recessed mounted version

1 PROFILE MOUNTING

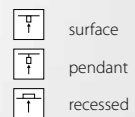

surface
pendant
recessed

2 SPOTS

A 1 spot
H 2 spots
E 3 spots
4 spots
5 spots

3 COLOUR (SPOT, HOUSING & COVER)

1 silver **SISI**
2 white **WSWS**
3 black **SWSW**
4 RAL of your choice
5

4 LED

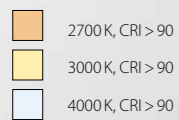

2700 K, CRI > 90
3000 K, CRI > 90
4000 K, CRI > 90

5 CONTROL

927 non-dim
930 DALI
940

6 BEAM ANGLE

X1 12° **1**
X3 32° **3**

P30-1 ZBS 2 N 3 4 5 6

P30-AZBS1NSWSW927X11 surface mounted p.thirty segment, zenit XXS surface variable, single spot, black tube, black spot, black housing & blank cover, 2700 K, CRI > 90, non-dim, 12°, IP20 (order sample)

► [Configure online on KATALOG.PLANLICHT.COM](https://www.planlicht.com)

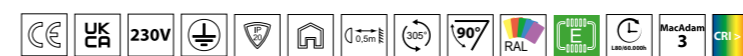

Down to UGR ≤ 16 | up to 56 lm/W | IEC 62471: Blue light hazard: RG ≤ 1 | DALI push switchDIM

zenit XXS segment for p.thirty

Systeme | Segmente
Systems | Segments

ZENIT XXS | SYSTEMS

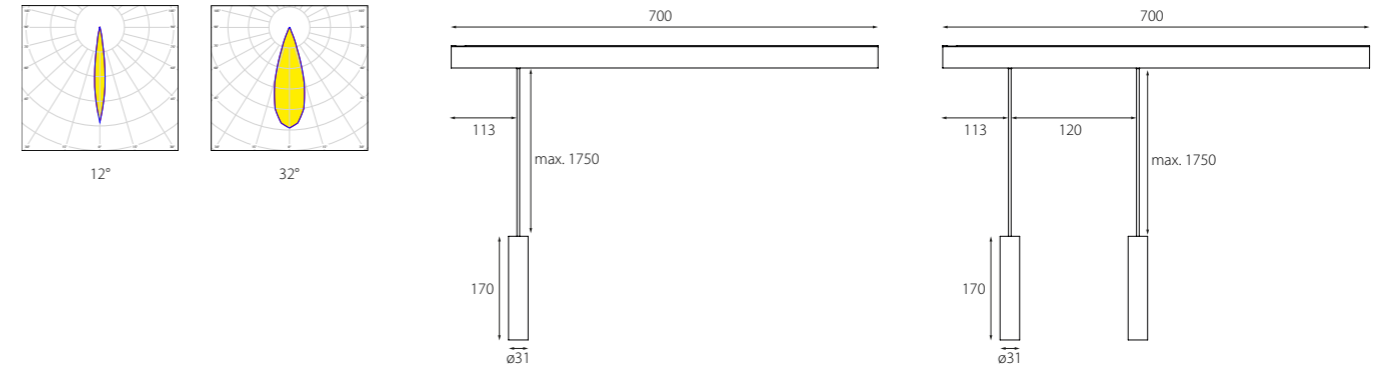
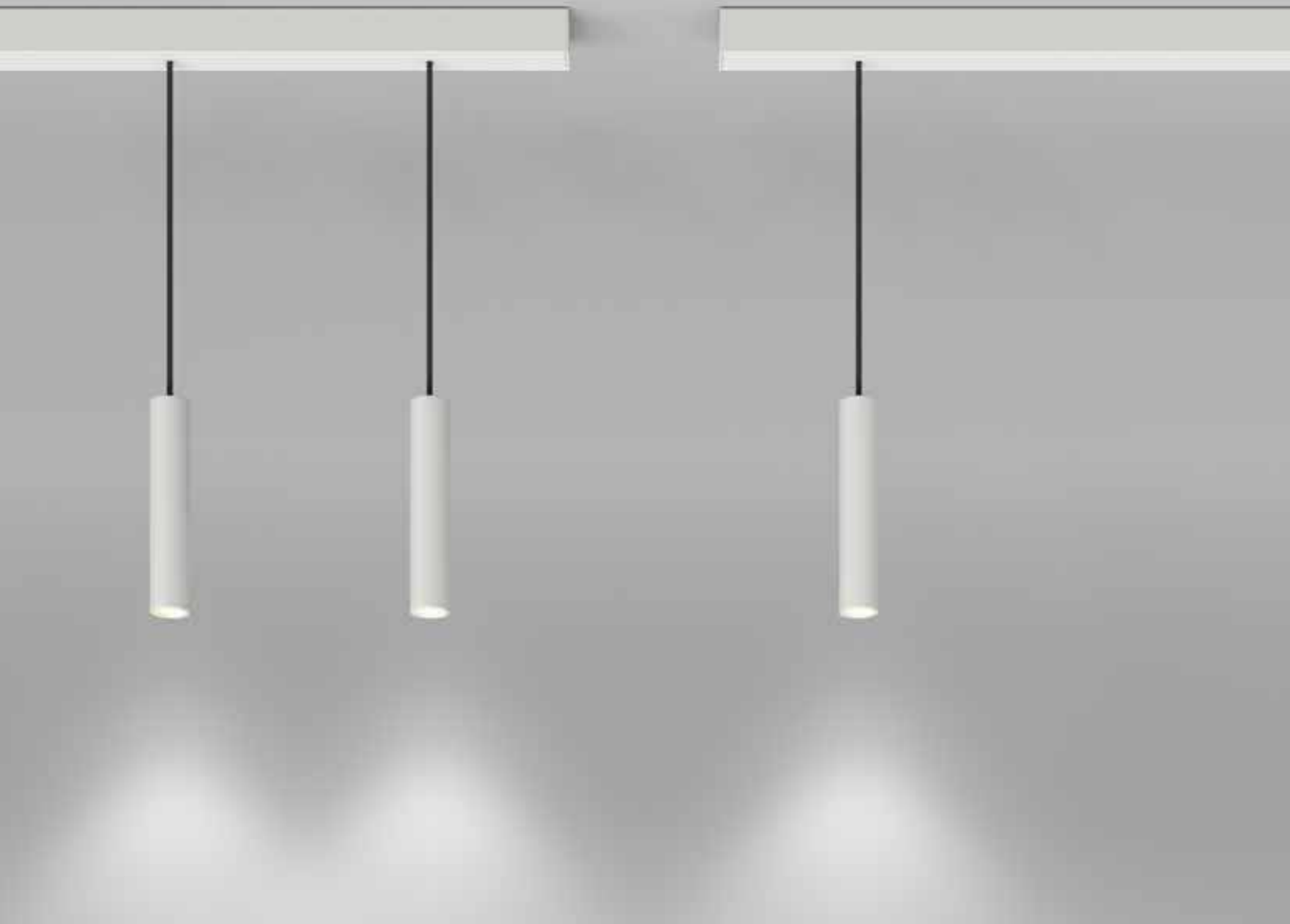

LUMINOUS FLUX (LM) / SYSTEM POWER (W)

	12°		32°	
	1 pendant (7W)	2 pendants (11,5W)	1 pendant (7W)	2 pendants (11,5W)
LF927 2700 K	183lm	366lm	272lm	544lm
LF930 3000 K	189lm	378lm	280lm	560lm
LF940 4000 K	197lm	394lm	292lm	584lm

WEIGHT

1 pendant	1,0kg
2 pendants	1,3kg

Basierend auf der Einbauversion | based on recessed mounted version

1 PROFILE MOUNTING

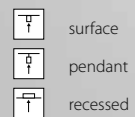

surface
pendant
recessed

2 PENDANTS

A 1 pendant
H 2 pendants
E

3 COLOUR (SPOT, HOUSING & COVER)

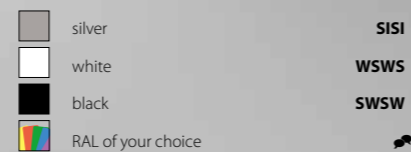

4 LED

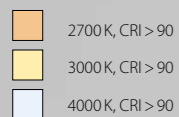

2700 K, CRI > 90
3000 K, CRI > 90
4000 K, CRI > 90

5 CONTROL



927 non-dim
930 DALI
940

6 BEAM ANGLE



P30-1 ZHS 2 N 3 4 5 6

P30-AZHS2NSWSW927X11 surface mounted p.thirty segment, 2 zenit XXS pendants, black tube, black spot, black housing & blank cover, 2700K, CRI > 90, non-dim, 12°, IP20 (order sample)

► [Configure online on KATALOG.PLANLICHT.COM](#)



Down to UGR ≤ 16 | up to 51 lm/W | IEC 62471: Blue light hazard: RG ≤ 1 | DALI push switchDIM

FARBKARTEN | GEHÄUSE & KABEL

COLOUR CHARTS | HOUSING & CABLES



Optionale Ausführung | *Optional version*

Einspeiskabel
Suspension cable

1750 mm
5x0,75 mm²

▷ white	*-EIN-WHITE	
▷ black	*-EIN-BLACK	
▷ red	*-EIN-RED	
▷ iron	*-EIN-IRON	
▷ gold	*-EIN-GOLD	
▷ silver	*-EIN-SILVER	

Transparentes Kabel inkl. (Standard Version) | *Transparent cable included (standard version)*

für besondere Anfragen | *for special requests*

RAL NACH WAHL | OPTIONALE GEHÄUSEFARBEN

RAL OF YOUR CHOICE | OPTIONAL HOUSING COLOURS



FARBKARTEN | DIFFUSOREN & OPTIKEN
COLOUR CHARTS | DIFFUSERS & OPTICS

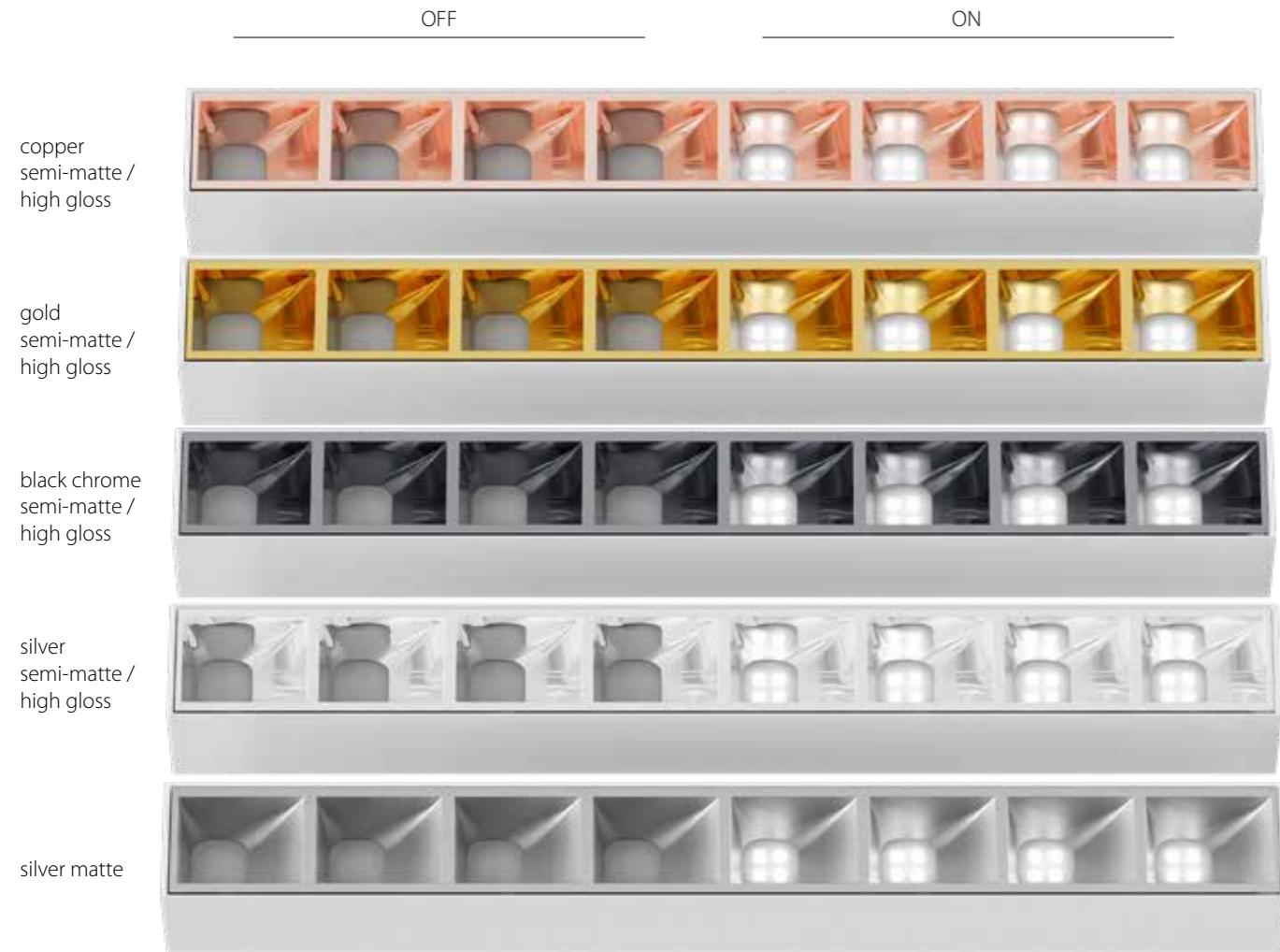

WICHTIGE HINWEISE

Dieser Katalog richtet sich ausschliesslich an gewerbliche Kunden. Die in diesem Katalog angegebenen Werte sind Bemessungswerte und unterliegen produktionsbedingten Toleranzen*. Alle angeführten Angaben – insbesondere Grössen-, Material-, Farb- und technische Angaben – entsprechen dem Stand zum Zeitpunkt des Drucks und dienen ausschliesslich zur Information. Der Herausgeber haftet nicht für Satz- und Druckfehler sowie für Abweichungen der Produkte von Abbildungen und Angaben. PLANLICHT behält sich vor, jederzeit ohne Ankündigung Änderungen an Produkten vor zu nehmen. Es gelten die Allgemeinen Geschäftsbedingungen der planlicht GmbH & Co KG, die unter WWW.PLANLICHT.COM/AGB-LANDING/ eingesehen werden können.

Technische Kennzahlen, angeführte Werte und die Piktogramme betreffen zumindest einen aber nicht zwingend alle Artikel der jeweiligen Leuchtenfamilie, exakte Angaben je Artikel finden Sie im Online-Katalog bzw. in PLANLICHT-Verkaufsbelegen und Datenblättern.

WEEE-Reg.-Nr. DE 54728470

* Leistung, Lichtstrom und Farbtemperatur unterliegen durch den Einsatz von elektronischen Bauteilen produktionsbedingten Toleranzen. Toleranzen Leistung und Lichtstrom: +/- 10%. Toleranz Farbtemperatur: +/- 150 K. Lichtstrom dynamisch weiss bei 2700 K.

IMPORTANT REMARKS

This catalogue is reserved for professionals only. The values published in this catalogue are rated values, which can slightly change for reasons related to the production process. The published data such as dimensions, materials, colours and technical data are valid at time of printing, and exclusively provided for informational purposes. The editor takes no responsibility for typographical and print errors, as well as for any differences in the products, pictures and data. PLANLICHT reserves the right to change the products at any time and without any notice. The Terms and Conditions of planlicht GmbH & Co KG (available on WWW.PLANLICHT.COM/AGB-LANDING/) shall apply.*

Key technical specifications, listed values as well as the pictogram bar relate to at least one but not necessarily all items of the respective luminaire family, exact details for each item can be found in the online web catalogue or in PLANLICHT sales documents and data sheets.

** The power output, luminous flux and colour temperature can be slightly different due to specific electronic components used in the manufacturing process. The power output and luminous flux can differ by +/- 10%. The colour temperature can differ by +/- 150 K. Luminous flux dynamic white at 2700 K.*

RELEVANTE INFORMATIONEN AUF EINEN BLICK

- Allgemeine Geschäfts- & Lieferbedingungen – Die Grundlage unserer Zusammenarbeit
- Garantie 66 – Das Qualitätsversprechen im Detail
- Technische Hinweise – Wichtige Informationen zur Planung
- Produktseiten – So lesen Sie unsere Übersichten
- Artikelnummer – Die Logik hinter dem Code
- Piktogramme – Die Symbole und ihre Bedeutung



RELEVANT INFORMATION AT A GLANCE

- *Terms & Conditions – The Basis of Our Cooperation*
- *Guarantee 66 – Our Commitment to Quality*
- *Technical Notes – Essential Guidance for Planning*
- *Product Pages – How to Read Our Overviews*
- *Article Number – The Logic Behind the Code*
- *Pictograms – The Meaning Behind the Symbols*

SENSORS

Stand alone, ambient light & motion detection
BLINDADECKUNG | BLANK COVER



P. THIRTY

Length luminaire
+190 mm

IMPRINT

Publisher: planlicht GmbH & Co. KG, Vomp
Creative Concept: Katrin Atzinger
Graphic Design: Beatrice Praxmarer, Christoph Höflinger
Print: Kraler Druck, Vahrn (BZ)
© 2026



6134 Vomp, Austria, Au 25
Tel. +43-5242-71608, Fax +43-5242-71283
info@planlicht.com
WWW.PLANLICHT.COM



WWW.PLANLICHT.COM