

3-PHASEN-LEUCHTEN

3-PHASE TRACK LIGHTS

 planlicht



3-PHASEN-LEUCHTEN |

3-PHASE TRACK LIGHTS

DIE PLANLICHT 3-PHASEN-LEUCHTEN IM ÜBERBLICK

PLANLICHT 3-PHASE TRACK LIGHTS AT A GLANCE



P.FORTY
LIGHTING TECHNOLOGY
MEETS EYE COMFORT



LILIBET
THAT CERTAIN
SOMETHING



PURE 3
SHAPELY FLEXIBILITY



OLMO
SQUARE SHAPED
EFFICIENCY

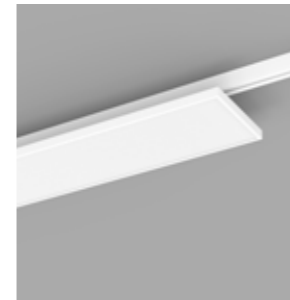

P.BRIGHT
BRILLIANT. EFFICIENT.
VERSATILE.



METEOR
ACCENTS WITH
PURPOSE



OPHELIA
SIMPLICITY



ZENIT
DESIGNER'S SPOTLIGHT
FAMILY



ODELIA
PURE ELEGANCE

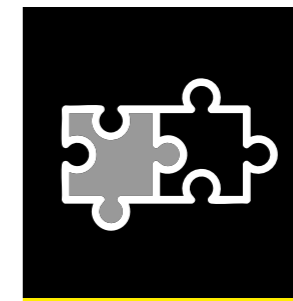

COMPONENTS

P.FORTY | LIGHTING TECHNOLOGY MEETS EYE COMFORT

p.forty ist die Meisterin der Montagearten: kaum eine Anbringungsart ist ihr fremd und so sind ihre Einsatzgebiete vielfältig. Die dezente Profileuchte mit hohem Sehkomfort ist zudem mit einer Vielzahl an unterschiedlichen Diffusoren erhältlich.

p.forty is the master of mounting types: hardly any mounting method isn't applicable and so its areas of application are diverse. The discreet profile luminaire with high visual comfort is also available with a variety of different diffusers.



3-PHASE-TRACK LIGHT

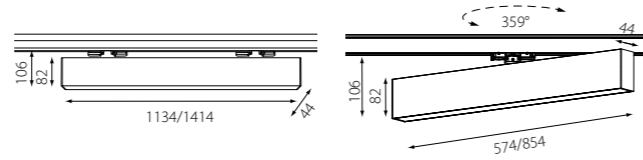
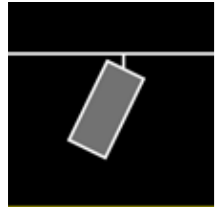

LICHT NL | NIEDERLANDE

Produkte: p.forty & zenit S 3-Phasen-Leuchten

LICHT NL | NETHERLANDS

Products: p.forty & zenit S 3-Phase Track Lights



RAIBA STRAUBING | DEUTSCHLAND

Produkte: p.forty & zenit M 3-Phasen-Leuchten, sinus
Foto: © Ulrich Buha

RAIBA STRAUBING | GERMANY

Products: p.forty & zenit M 3-Phase Track Lights, sinus
Photo: © Ulrich Buha

PURE 3 | SHAPELY FLEXIBILITY

pure 3 steht für maximale Flexibilität: unterschiedliche Montagearten, vielfältige Diffusoroptionen und eine breite Auswahl an Gehäusefarben machen die Leuchte zu einem vielseitigen Werkzeug für architektonische Lichtlösungen. Dabei bleiben Homogenität, Effizienz und höchste Lichtqualität stets im Fokus.

pure 3 embodies maximum flexibility: a variety of mounting options, a broad selection of diffusers and a wide range of housing colours make this luminaire a versatile tool for architectural lighting solutions. Homogeneity, efficiency and outstanding light quality always remain at the forefront.

3-PHASE TRACK LIGHT

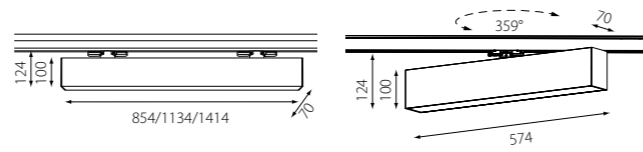
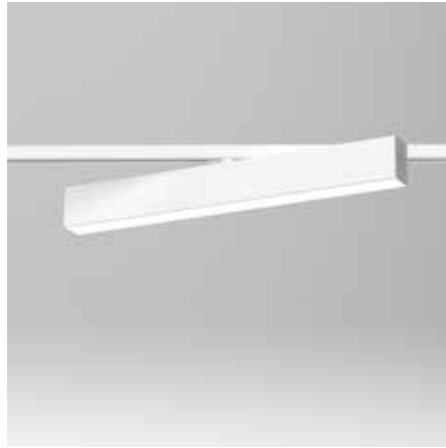
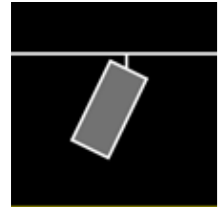

OPHELIA | SIMPLICITY

opelia mit ihrem flachen, runden Design und dem nahtlosen Gehäuse, welches in unzähligen Farben verfügbar ist, sorgt nicht nur für perfekte Beleuchtung sondern ist schon für sich ein Hingucker.

opelia with its flat, round design and seamless housing, which is available in countless colours, not only provides perfect lighting but is an eye-catcher in itself.

3-PHASE TRACK LIGHT

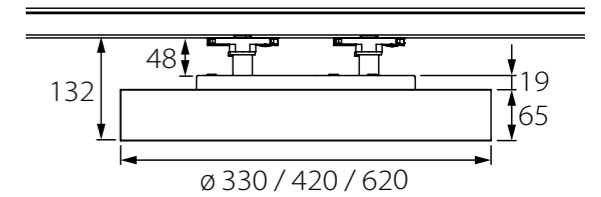
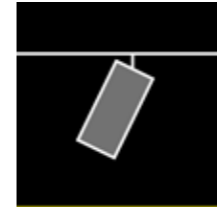

P.BRIGHT | BRILLIANT. EFFICIENT. VERSATILE.

p.bright – die flachste Profileuchte von PLANLICHT – begeistert mit großzügigem, homogenem Licht und einem dezenten, reduzierten Design. Sie fügt sich in anspruchsvolle Architektur ein und bietet gleichzeitig die Flexibilität, Projekte individuell und effizient zu beleuchten.

p.bright – the slimmest profile luminaire from PLANLICHT – impresses with generous, uniform illumination and a discreet, minimalist design. It integrates seamlessly into sophisticated architectural environments while offering the flexibility needed to illuminate projects individually and efficiently.

3-PHASE TRACK LIGHT

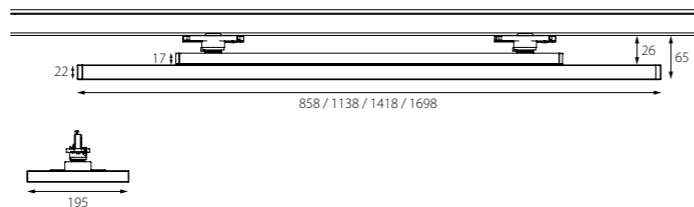
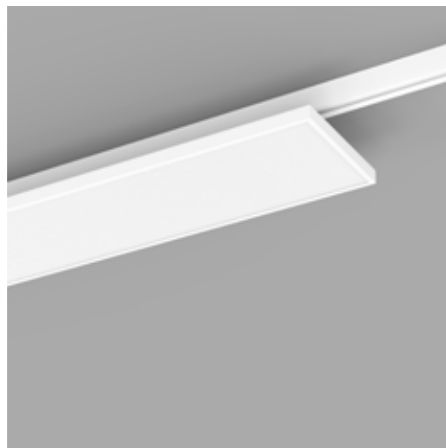
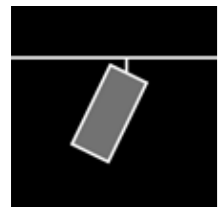

ODELIA | PURE ELEGANCE

odelia besticht immer durch ihre pure Eleganz. Zudem kann odelia mit ihrem geschmackvollen Designrahmen und einem simplen Gehäuse tausende Farbkombinationen zum Leben erwecken und auch durch die Bi-Colour-Option besondere Akzente im Raum setzen.

odelia always impresses with its pure elegance. With its tasteful design frame and simple housing odelia can bring thousands of colour combinations to life and set special accents with the bi-colour option.

3-PHASE TRACK LIGHT

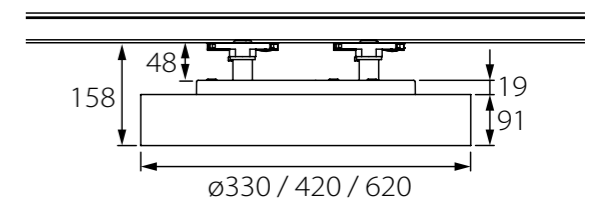

LILIBET | THAT CERTAIN SOMETHING

Beim Designen von lilibet standen die Eigenschaften hohe Energieeffizienz, Homogenität der Ausleuchtung und ein zeitloses Äußeres an erster Stelle. lilibet macht mit ihrem herausragenden Diffusor, dem dezenten Gehäuserahmen und den frei wählbaren Gehäuse- und Kabelfarben immer eine gute Figur.

When designing lilibet, the characteristics of high energy efficiency, homogeneity of illumination and a timeless appearance were paramount. lilibet always cuts a fine figure with its outstanding diffuser, discreet housing frame and freely selectable housing and cable colours.

3-PHASE TRACK LIGHT

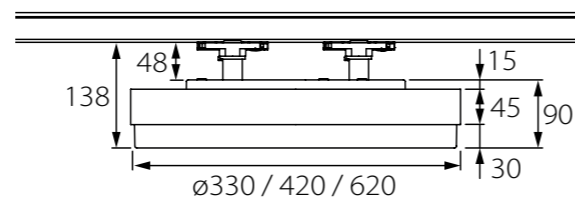

OLMO | SQUARE SHAPED EFFICIENCY

olmo quadratische Flächenleuchte im minimalistischen Design mit hoher Energieeffizienz. Die klaren Linien und die viereckige Ausprägung lassen sich wunderbar mit den unzähligen Farbvarianten des Gehäuses kombinieren und sorgen für ein individuelles Erhellung jeden Raums.

olmo square surface area luminaire with a minimalist design and high energy efficiency. The clear lines and the square design can be wonderfully combined with the million colour variations of the housing, which ensures the individual illumination of any room.

3-PHASE TRACK LIGHT

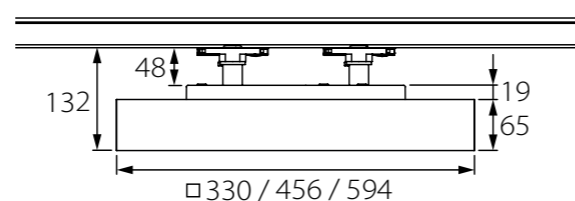

METEOR | ACCENTS WITH PURPOSE

meteor bringt präzise Lichtakzente dorthin, wo sie gebraucht werden: kompakt, fokussiert und mit leistungsstarker LED-Technologie ausgestattet. Der Strahler setzt gezielte Highlights und unterstützt Projekte, die klare, definierte Lichtpunkte verlangen.

meteor delivers precise lighting accents exactly where they are needed: compact, focused and equipped with powerful LED technology. This spotlight creates targeted highlights and supports projects that require clear, defined points of light.

3-PHASE TRACK LIGHT

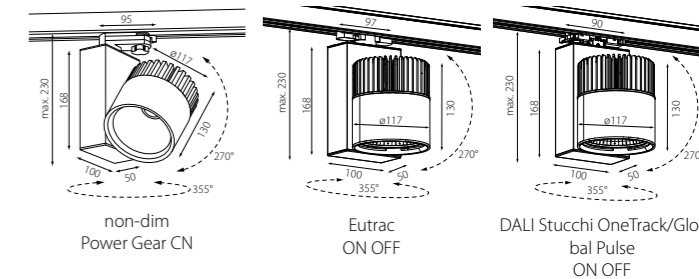

TELIAN KUVAT | FINLAND

Produkt: meteor 3-Phasen-Leuchte
Foto: © Timo Pyykonen Photography

TELIAN KUVAT | FINLAND

Product: meteor 3-Phase Track Light
Photo: © Timo Pyykonen Photography

ZENIT | DESIGNER'S SPOTLIGHT FAMILY

Ein optisch ansprechender Strahler, der die richtigen Highlights setzt? Das kann nur zenit sein. Spezielle Lichtfarben sorgen dafür, dass das in Szene zu setzende Objekt bestmöglich präsentiert wird – und das bei hoher Energieeffizienz.

A visually appealing spotlight that sets the right highlights? That can only be zenit. Special light colours ensure that the object to be staged is presented in the best possible way – and with high energy efficiency.

3-PHASE TRACK ZENIT S

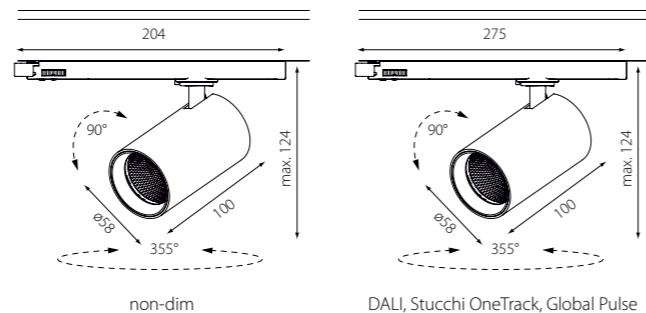
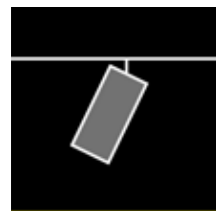

non-dim

DALI, Stucchi OneTrack, Global Pulse



HOLIDAY INN MESSUKESKUS | FINLAND

HOLIDAY INN MESSUKESKUS | FINLAND

Produkt: zenit M 3-Phasen-Leuchte
Foto: © Sampsa Pärnänen

Product: zenit M 3-Phase Track Lights
Photo: © Sampsa Pärnänen

ZENIT N+

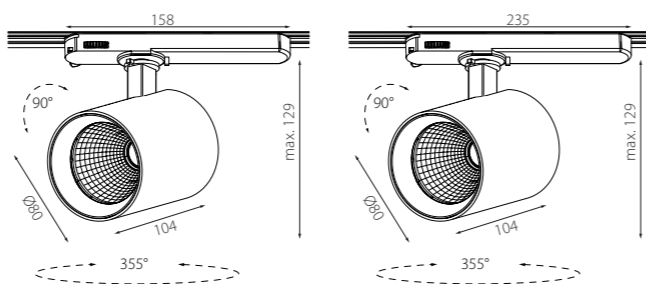

non-dim

DALI, Stucchi OneTrack, Global Pulse

ZENIT M

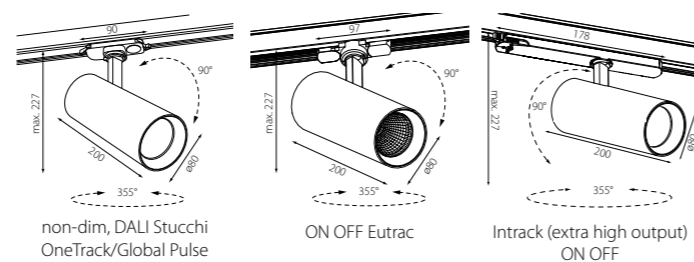

non-dim, DALI Stucchi OneTrack/Global Pulse

ON OFF Eutrac

Intrack (extra high output) ON OFF

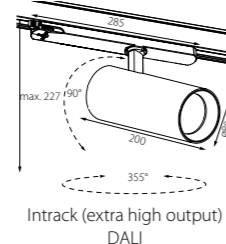

Intrack (extra high output) DALI



SCHLAFTRÄUME GRAZ | ÖSTERREICH

SCHLAFTRÄUME GRAZ | AUSTRIA

Produkt: zenit M 3-Phasen-Leuchte
Foto: © Alexander Künzel

Product: zenit M 3-Phase Track Lights
Photo: © Alexander Künzel

COMPONENTS

COMPONENTS NON-DIM

01 SURFACE-MOUNT TRACK

	1000 mm	676001AL
	1000 mm	676001SW
	1000 mm	676001WS
	2000 mm	676002AL
	2000 mm	676002SW
	2000 mm	676002WS
	3000 mm	676003AL
	3000 mm	676003SW
	3000 mm	676003WS
	4000 mm	676004AL
	4000 mm	676004SW
	4000 mm	676004WS

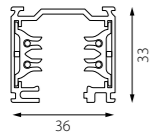

02 END CAP

	676011SI
	676011SW
	676011WS

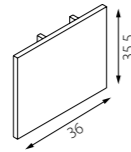

03 LINEAR CONDUCTIVE CONNECTOR

	676006SW
	676006WS

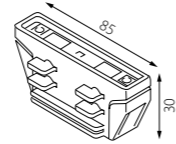

leitend
conductive

04 CLAMP

	676013
--	--------

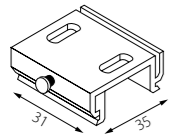

05 LINEAR NON-CONDUCTIVE CONNECTOR

	676023
--	--------

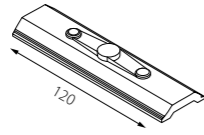

06 CENTRAL POWER FEED

	676007SI
	676007SW
	676007WS

07 POWER END FEED

	676004LSI
	676004LSW
	676004LWS

08 POWER END FEED

	676004RSI
	676004RSW
	676004RWS

10 X-CONNECTOR

	676022SI
	676022SW
	676022WS

11 FLEXIBLE CONNECTOR

	676010SI
	676010SW
	676010WS

09 COVER

	1000 mm	676019SW
	1000 mm	676019WS

12 T-CONNECTOR

	676012LSI
	676012LSW
	676012LWS
	676012RSI
	676012RSW
	676012RWS

13 L-CONNECTOR

	676008LSI
	676008LSW
	676008LWS
	676008RSI
	676008RSW
	676008RWS

14 CLIP CADDY T-RAIL

	SB0760
--	--------

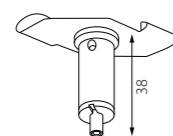

26 mm mit Schnellspanner,
für Stahlseil 1 mm.
26 mm with quick release,
for steel cable 1 mm.

15 CEILING ATTACHMENT WITH QUICK RELEASE

	26 mm, with quick release for steel rope 1 mm	B57100
--	--	--------

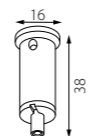

für Stahlseil 1 mm
for steel rope 1 mm

16 SUSPENSION ROPE

	2000 mm	676014SW
	2000 mm	676014WS
	6000 mm	676016SW
	6000 mm	676016WS

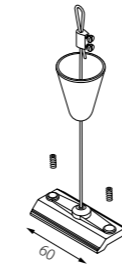

für Deckenhaken
for ceiling hooks

17 WITH CEILING MOUNTS

	2000 mm	676026WS
	6000 mm	676026WS-6

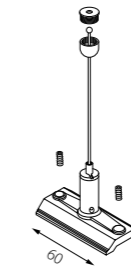

Inklusive Schnellspanner unten.
Include the quick release below.

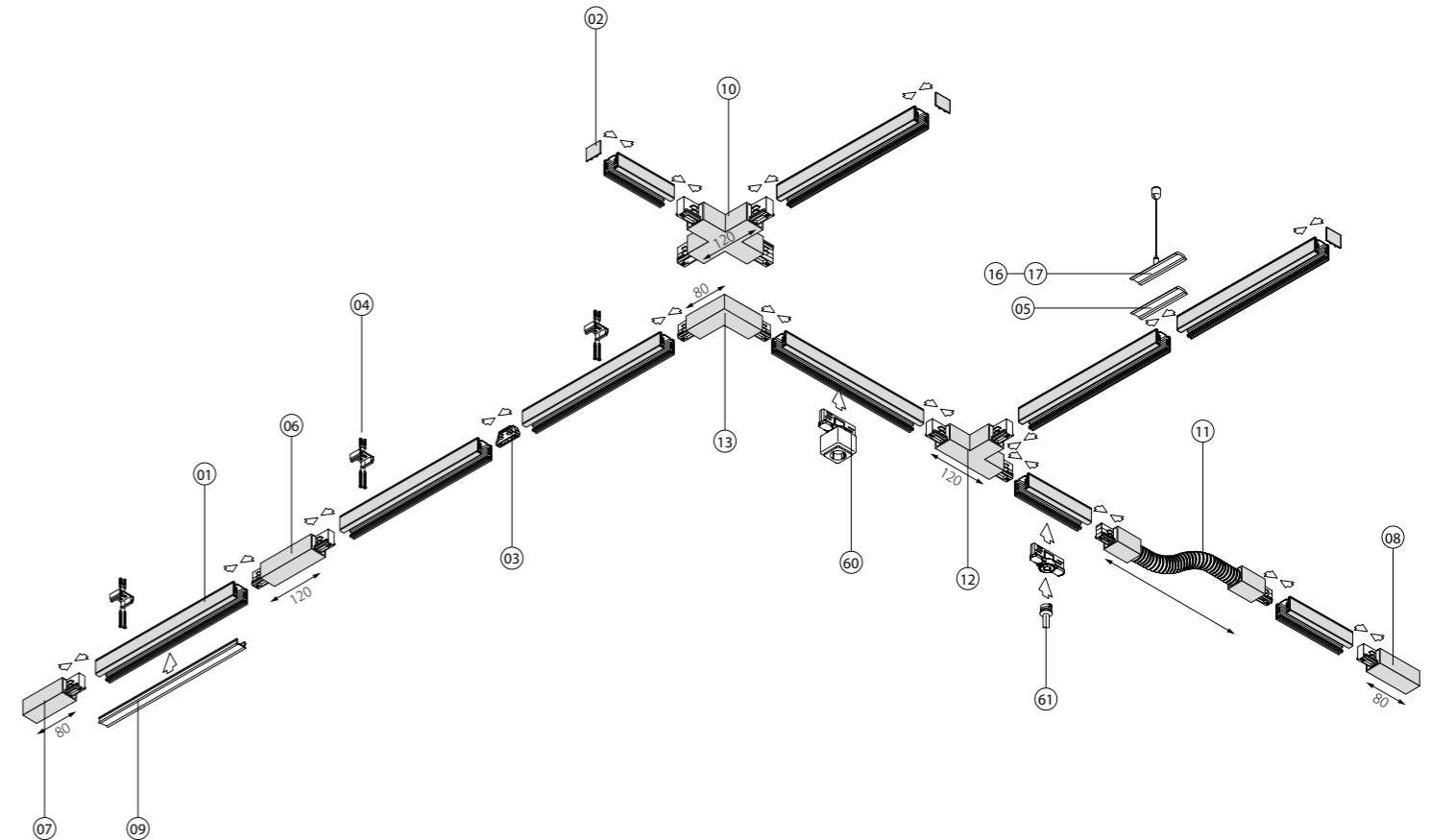

	left
	right
	inside
	outside
	silver
	black
	white
	chrome



21 RECESSED TRACK

	1000mm	679001AL
	1000mm	679001SW
	1000mm	679001WS
	2000mm	679002AL
	2000mm	679002SW
	2000mm	679002WS
	3000mm	679003AL
	3000mm	679003SW
	3000mm	679003WS
	4000mm	679004AL
	4000mm	679004SW
	4000mm	679004WS

22 END CAP

	677659I00W20
	677659I00W30
	677659I00W31

23 CENTRAL POWER FEED

	679007SI
	679007SW
	679007WS

24 POWER END FEED

	679004LSI
	679004LSW
	679004LWS
	679004RSI
	679004RSW
	679004RWS

03 LINEAR CONDUCTIVE CONNECTOR

	676006SW
	676006WS

leitend
conductive

05 LINEAR NON-CONDUCTIVE CONNECTOR

	676023
--	--------

09 COVER

	1000mm	676019SW
	1000mm	676019WS

10 RECESSED HOUSING FOR MONOPOINT

	424-9000-BRU-B
	424-9000-BRU-W

Adapter für Basis 9000-BPU
Adapter for base 9000-BPU

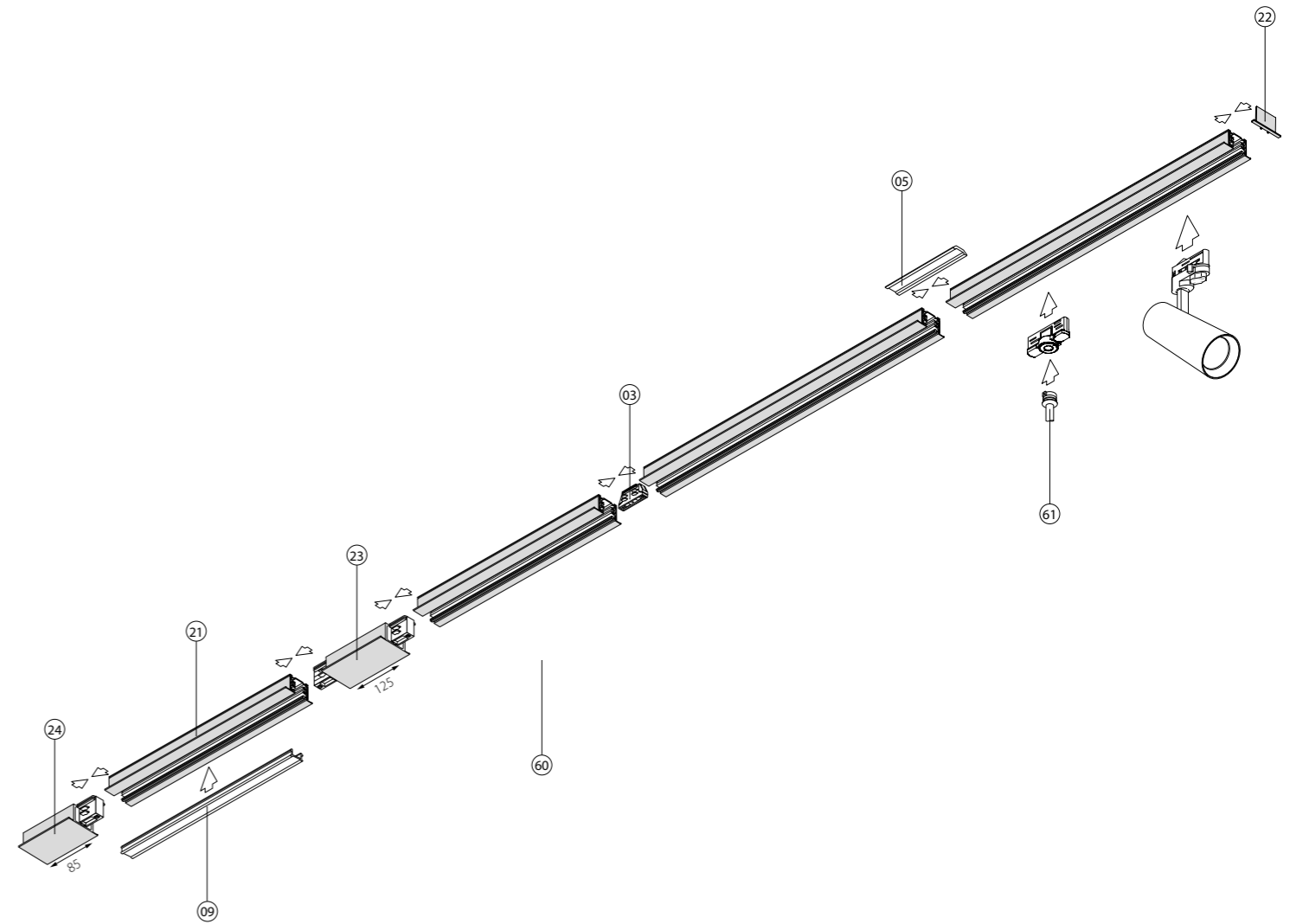
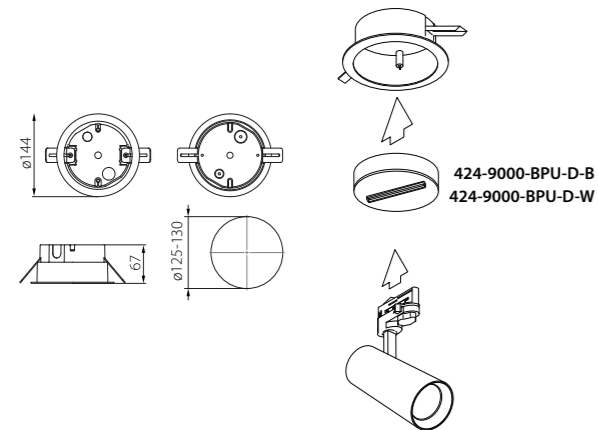
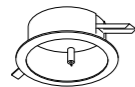

- left
- right
- silver
- white
- black



01 SURFACE-MOUNT TRACK

- 1000mm 6775401030
- 1000mm 6775401031
- 2000mm 6775402030
- 2000mm 6775402031
- 3000mm 6775403030
- 3000mm 6775403031

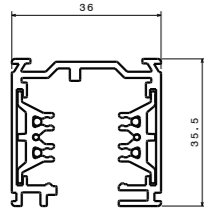

02 END CAP

- 677659D00W30
- 677659D00W31

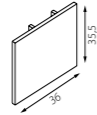

03 LINEAR CONDUCTIVE CONNECTOR

- 677548Q10W30
- 677548Q10W31



leitend
conductive

04 CLAMP

- 676013

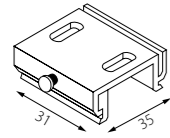

05 RAIL CONNECTOR

- 676023

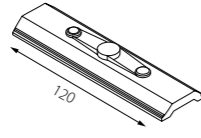

06 CENTRAL POWER FEED

- 67754210W30
- 67754210W31

07 POWER END FEED

- 67754111W30
- 67754111W31

08 POWER END FEED

- 67754110W30
- 67754110W31

09 COVER

- 1000mm 676019SW
- 1000mm 676019WS

10 X-CONNECTOR

- 67754510W30
- 67754510W31

11 FLEXIBLE CONNECTOR

- 67754610W30
- 67754610W31

12 T-CONNECTOR

- 67754411W30
- 67754411W31
- 67754410W30
- 67754410W31

13 L-CONNECTOR

- 67754310W30
- 67754310W31
- 67754311W30
- 67754311W31

14 CLIP CADDY T-RAIL

- SB0760

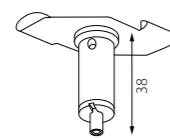

26 mm mit Schnellspanner,
für Stahlseil 1 mm.
26 mm with quick release,
for steel cable 1 mm.

15 CEILING ATTACHMENT WITH QUICK RELEASE

- 26 mm, with quick release
for steel rope 1 mm B57100

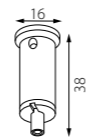

für Stahlseil 1 mm
for steel rope 1 mm

16 SUSPENSION ROPE

- 2000mm 676014SW
- 2000mm 676014WS
- 6000mm 676016SW
- 6000mm 676016WS

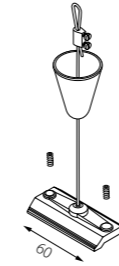

für Deckenhaken
for ceiling hooks

17 WITH CEILING MOUNTS

- 2000mm 676026WS
- 6000mm 676026WS-6

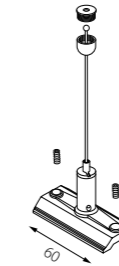

Inklusive Schnellspanner unten.
Include the quick release below.

18 MONOPOINT

- 424-9000-BPU-D-B
- 424-9000-BPU-D-W

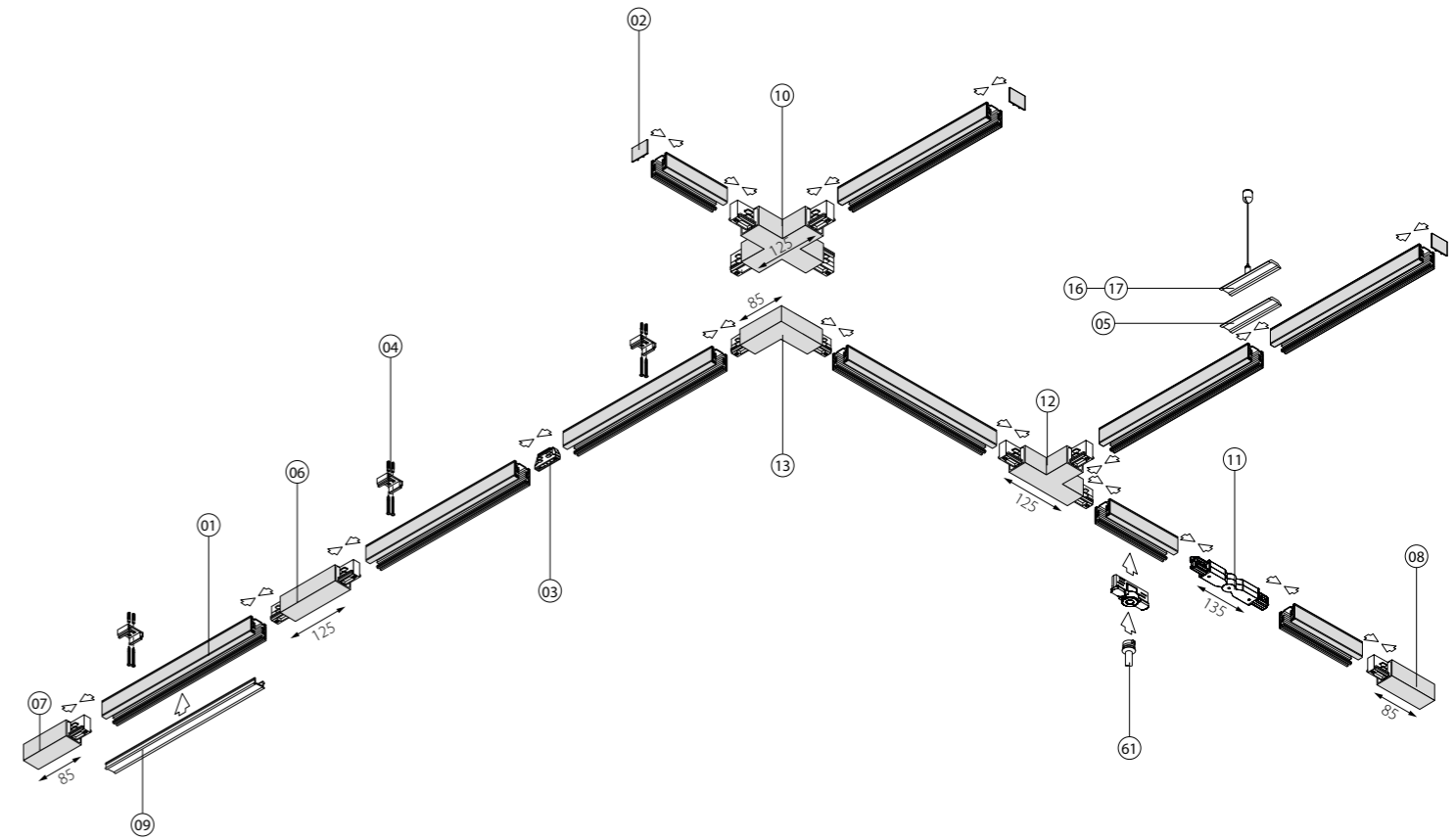
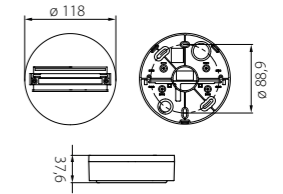
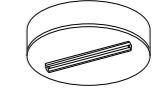

- left
- right
- inside
- outside
- silver
- black
- white
- chrome



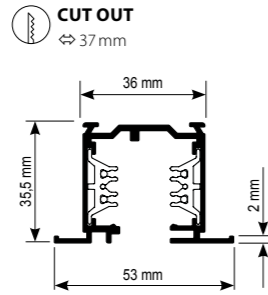

21 RECESSED TRACK

	1000 mm	6775601030
	1000 mm	6775601031
	2000 mm	6775602030
	2000 mm	6775602031
	3000 mm	6775603030
	3000 mm	6775603031
	4000 mm	6775604030
	4000 mm	6775604031



22 END CAP

	677659ID00W30
	677659ID00W31



23 CENTRAL POWER FEED

	67756210W30
	67756210W31

24 POWER END FEED

	67756111W30
	67756111W31
	67756110W30
	67756110W30

03 LINEAR CONDUCTIVE CONNECTOR

	677548Q10W30
	677548Q10W31

leitend
conductive





05 RAIL CONNECTOR

	676023
---	--------







09 COVER

	1000 mm	676019SW
	1000 mm	676019WS







06 X-CONNECTOR + COVER

	X-Connector	67754510W30
	X-Connector	67754510W31
	Cover	678404842A30
	Cover	678404842A31

07 T-CONNECTOR + COVER



	T-Connector	67754411W30
	T-Connector	67754411W31
	T-Connector	67754410W30
	T-Connector	67754410W31
	Cover	678404840A30
	Cover	678404840A31

08 L-CONNECTOR + COVER

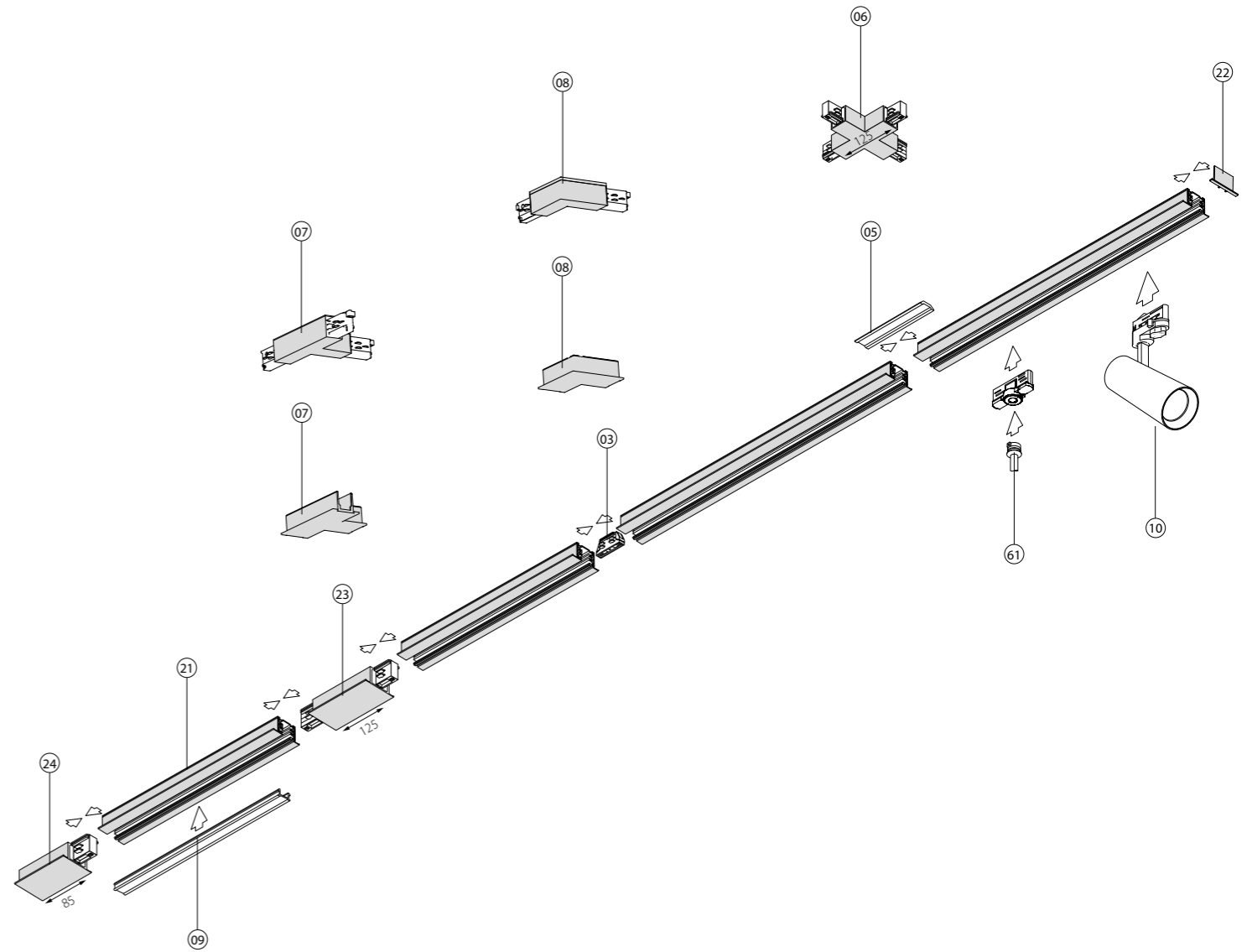
	L-Connector	67754310W30
	L-Connector	67754310W31
	L-Connector	67754311W30
	L-Connector	67754311W31
	Cover	678404841A30
	Cover	678404841A31



10 RECESSED HOUSING FOR MONOPOINT

	424-9000-BRU-B
	424-9000-BRU-W

Adapter für Basis 9000-BPU
Adapter for base 9000-BPU

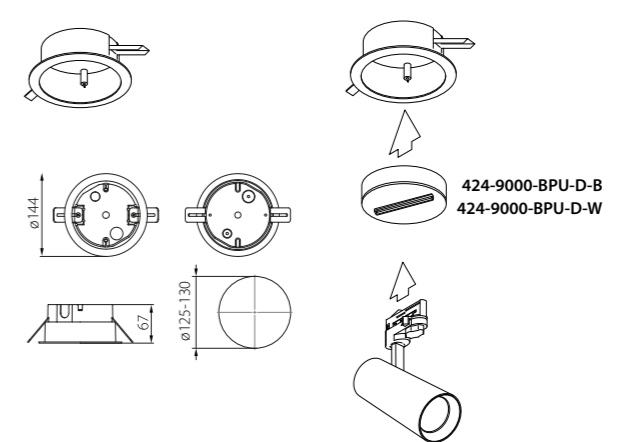

-  left
-  right
-  silver
-  white
-  black



COMPONENTS - ADAPTERS

03 STUCCHI INSTALLATION TOOL



 **424-S-9009-T-INS**
Einbauwerkzeug-Einsatz für Adapterverdrahtung.
Installation tool insert for adapter wiring.

STUCCHI SUSPENSION HOOK

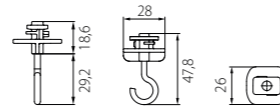
 **424-S-9000-H-B**
 **424-S-9000-H-W**



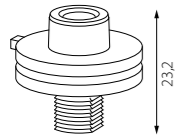

04 STUCCHI MOUNTING NIPPLE

 **424-S-9009-M10**
 **424-S-9009-M13**
M10 und M13 aus Aluminium, zur Aufnahme von Spots.
M10 and M13 made of aluminum, for holding spots.



05 STUCCHI MOUNTING NIPPLE FOR CABLE

 **424-S-9009-BC-B**
 **424-S-9009-BC-W**
Für Mantelleitung, DALI-Mantelleitung, inkl. Zugentlastung aus Aluminium.
For sheathed cable, DALI sheathed cable, incl. strain relief made of aluminium.

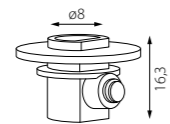

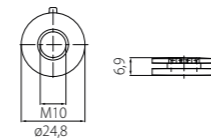

61 STUCCHI MOUNTING NIPPLE M10

 **424-S-9009-M10-FI**
Nippel mit M10 Innengewinde für Adapter 9009, 9209, 9409.
Nipples with M10 internal thread for adapters 9009, 9209, 9409.



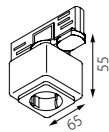

60 EUTRAC SCHUKO-ADAPTER NON-DIM

 **71990952**
 **71990956**
Für den Anschluss von Geräten der Schutzklasse I (System Schuko) bzw. universell einsetzbar für Geräteflachstecker Schutzklasse II, für Netzspannung 220-240V mit Sicherung 6,3 A, träge.
For the connection of devices of protection class I (System Schuko) or universally applicable for flat plugs of protection class II, for mains voltage 220-240V with fuse 6,3 A, slow.



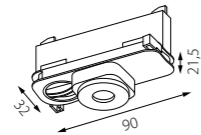

01 STUCCHI MULTI-DALI ADAPTER

 **424-9009-B**
 **424-9009-W**
Für Datenbusschiene, kompatibel mit: LKM DALI, AAG-Stucchi mit Datenbus und Nordic/Global Track Pulse.
For data bus rail, compatible with: LKM DALI, AAG-Stucchi with data bus and Nordic / Global Track Pulse.



02 STUCCHI NON-DIM ADAPTER

 **424-9009-4-B**
 **424-9009-4-W**
Universal-Adapter für nicht dimmbare 3-Phasen Schiene.
Universal adapter for non-dimmable 3-phase rail.

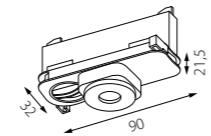

3 PHASE ADAPTER COMPATIBILITY

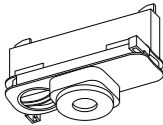
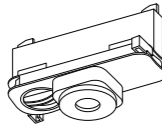
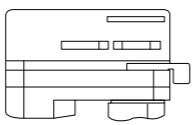
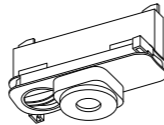
zenit M		meteor	
1	G	1	G
non-dim	Stucchi OneTrack	non-dim	Stucchi OneTrack
			
STUCCHI	STUCCHI	Powergear	STUCCHI

Einsetzbar in folgenden Schienen. Es handelt sich hier nur um eine Empfehlung, es wird weder von planlicht, noch vom Hersteller Garantie übernommen.
Can be used on the following tracks. This is only for information, planlicht nor the manufacturer will warranty any claim when not used in an approved track.

Ivela, Eutrac, Stucchi, Global, Unipro	LKM DALI, Stucchi DALI, DALI Global Track Pulse Control, Unipro	Ivela, Eutrac, Stucchi, Global, Unipro	LKM DALI, Stucchi DALI, DALI Global Track Pulse Control, Unipro
--	---	--	---



 black
 white
 aluminium

WICHTIGE HINWEISE

Dieser Katalog richtet sich ausschliesslich an gewerbliche Kunden. Die in diesem Katalog angegebenen Werte sind Bemessungswerte und unterliegen produktionsbedingten Toleranzen*. Alle angeführten Angaben – insbesondere Grössen-, Material-, Farb- und technische Angaben – entsprechen dem Stand zum Zeitpunkt des Drucks und dienen ausschliesslich zur Information. Der Herausgeber haftet nicht für Satz- und Druckfehler sowie für Abweichungen der Produkte von Abbildungen und Angaben. PLANLICHT behält sich vor, jederzeit ohne Ankündigung Änderungen an Produkten vor zu nehmen. Es gelten die Allgemeinen Geschäftsbedingungen der planlicht GmbH & Co KG, die unter WWW.PLANLICHT.COM/AGB-LANDING/ eingesehen werden können.

Technische Kennzahlen, angeführte Werte und die Piktogramme betreffen zumindest einen aber nicht zwingend alle Artikel der jeweiligen Leuchtenfamilie, exakte Angaben je Artikel finden Sie im Online-Katalog bzw. in PLANLICHT-Verkaufsbelegen und Datenblättern.

WEEE-Reg.-Nr. DE 54728470

* Leistung, Lichtstrom und Farbtemperatur unterliegen durch den Einsatz von elektronischen Bauteilen produktionsbedingten Toleranzen. Toleranzen Leistung und Lichtstrom: +/- 10%. Toleranz Farbtemperatur: +/- 150 K. Lichtstrom dynamisch weiss bei 2700 K.

IMPORTANT REMARKS

This catalogue is reserved for professionals only. The values published in this catalogue are rated values, which can slightly change for reasons related to the production process. The published data such as dimensions, materials, colours and technical data are valid at time of printing, and exclusively provided for informational purposes. The editor takes no responsibility for typographical and print errors, as well as for any differences in the products, pictures and data. PLANLICHT reserves the right to change the products at any time and without any notice. The Terms and Conditions of planlicht GmbH & Co KG (available on WWW.PLANLICHT.COM/AGB-LANDING/) shall apply.*

Key technical specifications, listed values as well as the pictogram bar relate to at least one but not necessarily all items of the respective luminaire family, exact details for each item can be found in the online web catalogue or in PLANLICHT sales documents and data sheets.

** The power output, luminous flux and colour temperature can be slightly different due to specific electronic components used in the manufacturing process. The power output and luminous flux can differ by +/- 10%. The colour temperature can differ by +/- 150 K. Luminous flux dynamic white at 2700 K.*

RELEVANTE INFORMATIONEN AUF EINEN BLICK

- Allgemeine Geschäfts- & Lieferbedingungen – Die Grundlage unserer Zusammenarbeit
- Garantie 66 – Das Qualitätsversprechen im Detail
- Technische Hinweise – Wichtige Informationen zur Planung
- Produktseiten – So lesen Sie unsere Übersichten
- Artikelnummer – Die Logik hinter dem Code
- Piktogramme – Die Symbole und ihre Bedeutung



RELEVANT INFORMATION AT A GLANCE

- *Terms & Conditions – The Basis of Our Cooperation*
- *Guarantee 66 – Our Commitment to Quality*
- *Technical Notes – Essential Guidance for Planning*
- *Product Pages – How to Read Our Overviews*
- *Article Number – The Logic Behind the Code*
- *Pictograms – The Meaning Behind the Symbols*

IMPRINT

Publisher: planlicht GmbH & Co. KG, Vomp
Creative Concept: Katrin Atzinger
Graphic Design: Beatrice Praxmarer, Christoph Höflinger
© 2026



6134 Vomp, Austria, Au 25
Tel. +43-5242-71608, Fax +43-5242-71283
info@planlicht.com
WWW.PLANLICHT.COM



3-PHASEN-LEUCHTEN

3-PHASE TRACK LIGHTS

WWW.PLANLICHT.COM