

RINGLEUCHTEN

RING LUMINAIRES



RINGLEUCHTEN
RING LUMINAIRES

DIE PLANLICHT-RINGLEUCHTEN IM ÜBERBLICK

PLANLICHT RING LUMINAIRES AT A GLANCE

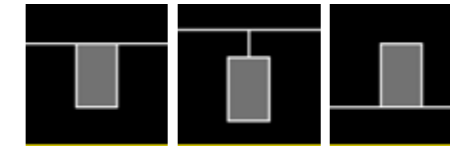

SINUS
LIGHTING UNLEASHED



HALO
CREATING ATMOSPHERE



SQING
HALF SQUARE. HALF RING.

SINUS | LIGHTING UNLEASHED

Die Ringleuchte beeindruckt durch hohen Sehkomfort (wahlweise homogener opaler Diffusor oder blendfreies Mikroprisma), verschiedene Lichtfarben inkl. HCL, unzählige Farbmöglichkeiten (Gehäuse, Kabel), direkte bzw. direkt/indirekte Lichtabgabe und optionale Sensoren.

The ring luminaire impresses with high visual comfort (choice of homogeneous opal diffuser or glare-free microprism), various light colours including HCL, countless colour options (housing, cable), direct or direct/indirect light emission and optional sensors.



SURFACE

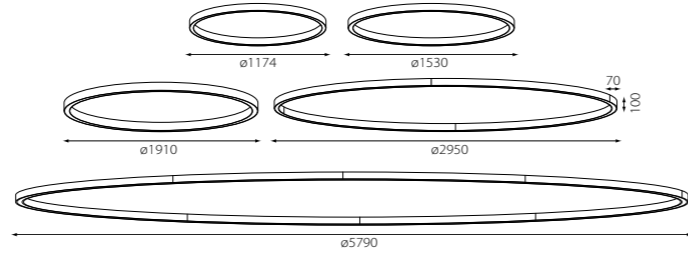
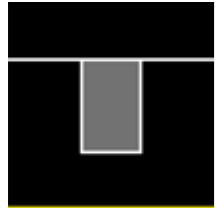

SINUS.QUIET

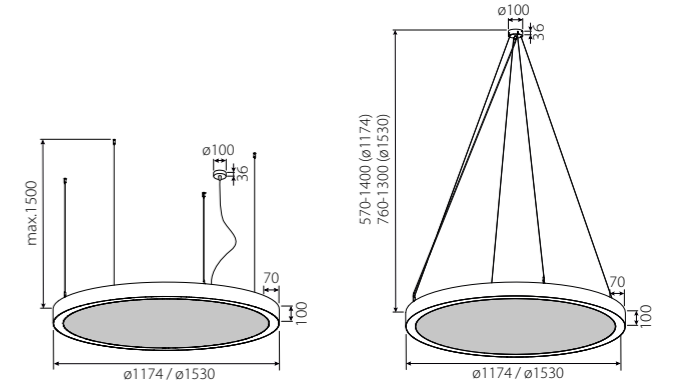

PENDANT

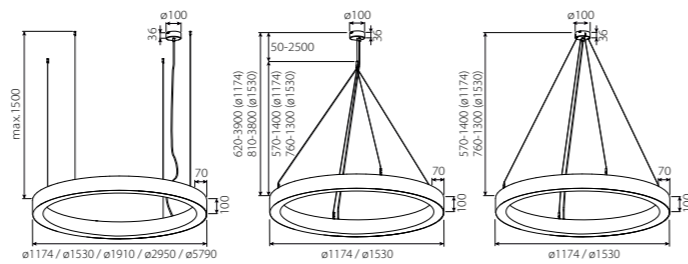
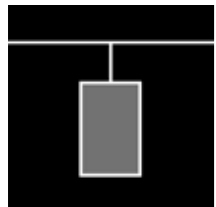

RECESSED

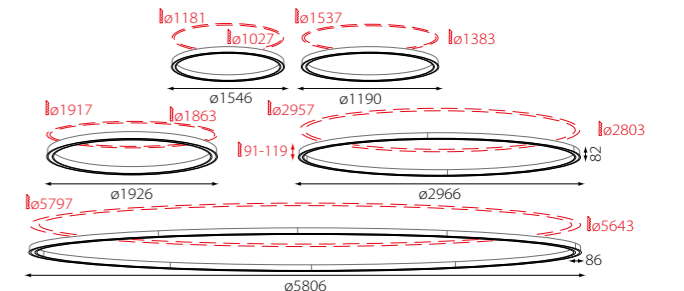
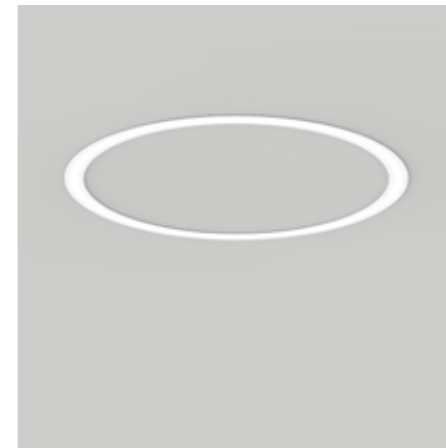
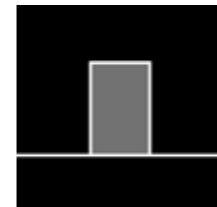

SINUS P.THIRTY

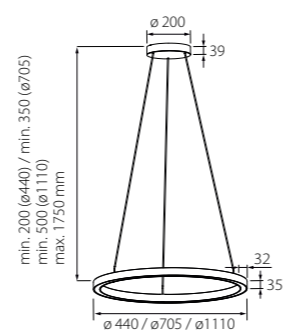

SINUS.QUIET

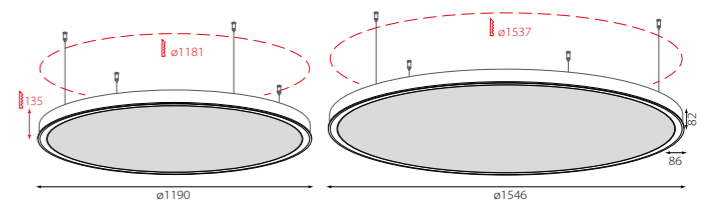
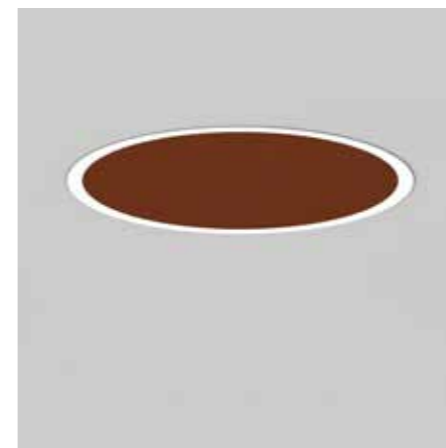



LAHDEN LUKIO GAUDIA | LAHTI, FINNLAND

Produkte: sinus, pure 3

LAHDEN LUKIO GAUDIA | LAHTI, FINNLAND

Products: sinus, pure 3

HALO | CREATING ATMOSPHERE

halo, die besondere Ringleuchte mit ihrem herausragenden, nahtlosen Diffusor, beeindruckt nicht nur durch edles direktes oder direkt-indirektes Licht mit dynamischem Weiß (2700 K – 6500 K). Auch das aus einem Guss produzierte und somit fugenfreie Leuchtgehäuse, welches in jeder gewünschten (RAL-)Farbe wählbar ist, spricht für sich.

halo, the special ring luminaire with its outstanding, seamless diffuser, not only impresses with its noble direct or direct-indirect light with dynamic white (2700 K – 6500 K) but also with the seamless luminaire housing, which can be selected in any desired (RAL) colour.

SURFACE

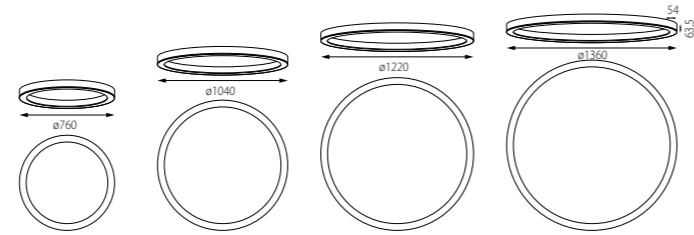
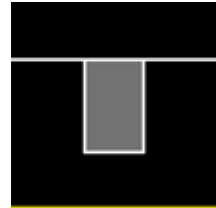

PENDANT

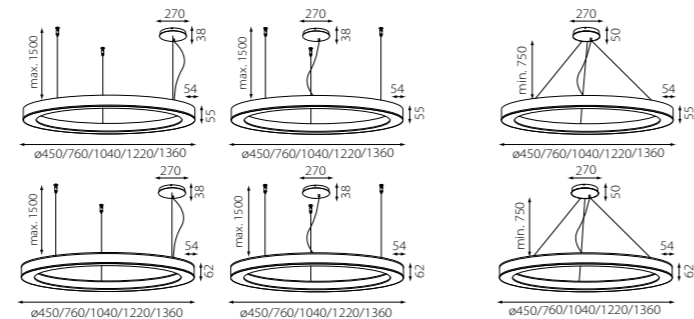
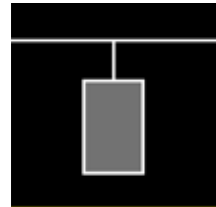

Design: Nina Mair

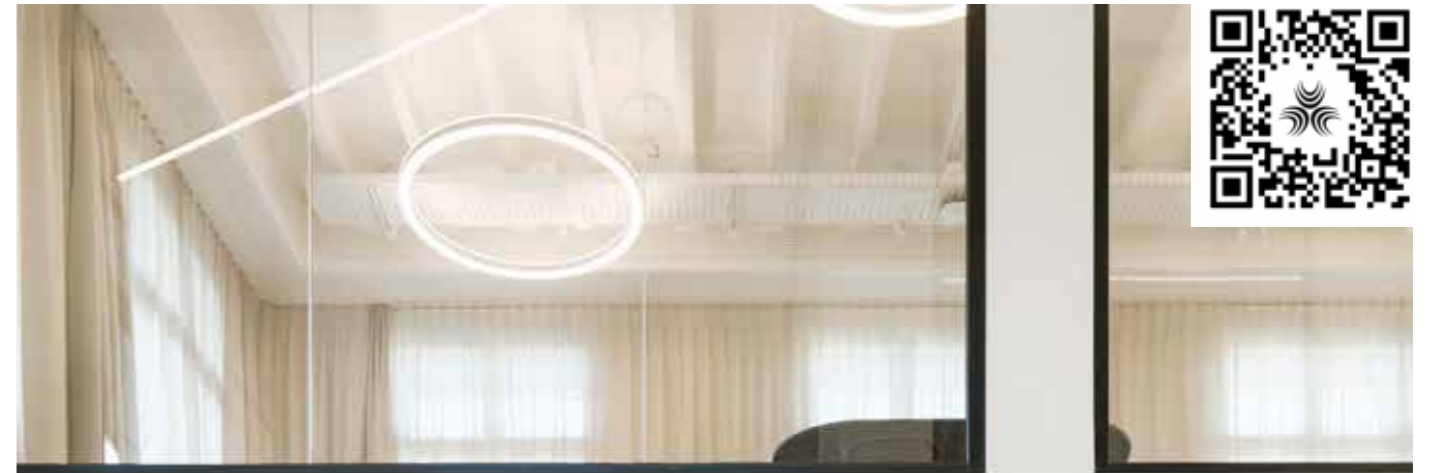

SIG COMBIBLOC SERVICES
NEUHAUSEN AM RHEINFALL | SCHWEIZ

Produkt: halo
Foto: Andrin Winteler | Architekt: Dost Innenarchitektur

SIG COMBIBLOC SERVICES
NEUHAUSEN AM RHEINFALL | SWITZERLAND

Produkt: halo
Photo: Andrin Winteler | Architect: Dost Innenarchitektur

SQING | HALF SQUARE. HALF RING.

Die Ringleuchte sqing vereint runde und eckige Formen! Der Eyecatcher unter den Leuchten basiert auf der PLANLICHT Design-Ikone halo und wurde wie diese von der österreichischen Designerin Nina Mair entwickelt.

The sqing ring luminaire combines round and angular shapes! The eye-catcher among the luminaires is based on the PLANLICHT design icon halo and was developed by the Austrian designer Nina Mair.



SURFACE

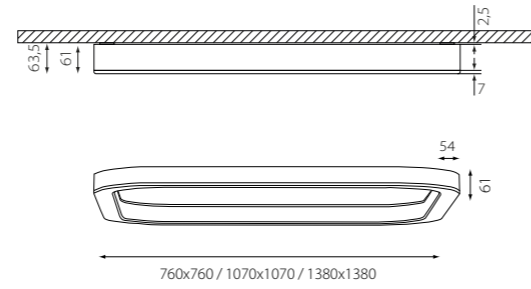
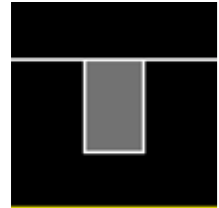

PENDANT

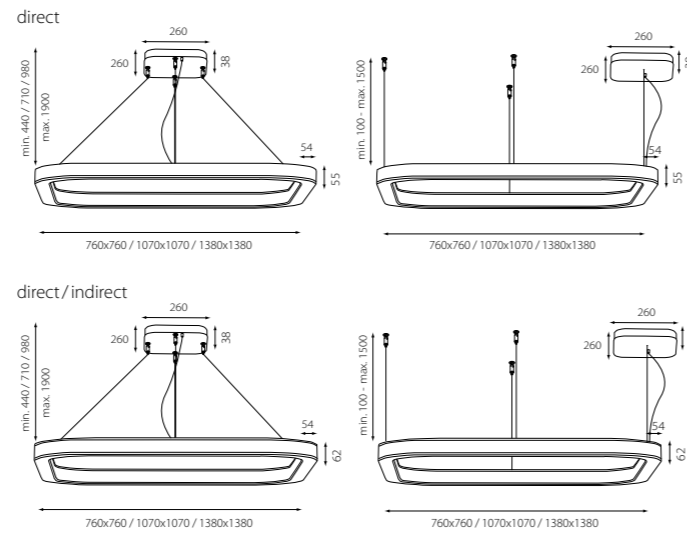
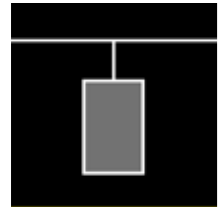

Design: Nina Mair



INSPIRATION

Produkt: sqing

INSPIRATION

Product: sqing

FARBKARTEN

COLOUR CHARTS

DIFFUSOREN

DIFFUSERS

Jet Black &
Light OFF

Satiné
OFF

Microprism
OFF

Extra
Comfort OFF



Jet Black &
Light ON

Satiné
ON

Microprism
ON

Extra
Comfort ON

GEHÄUSEFARBEN

HOUSING COLOURS

STANDARD

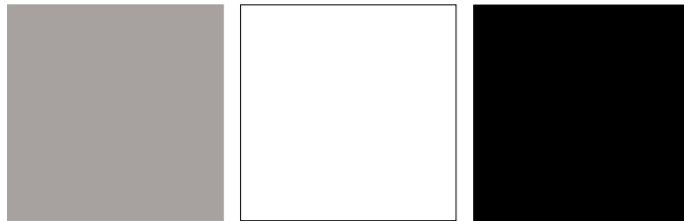

SILVER

WHITE

BLACK



AKUSTIK ABSORBER

ACOUSTIC ABSORBERS

FELT.QUIET



ANTHRACITE MELANGE

PEBBLE

BLUEBERRY

RUST

LIME

OLIVE GREEN

ORGANOID®

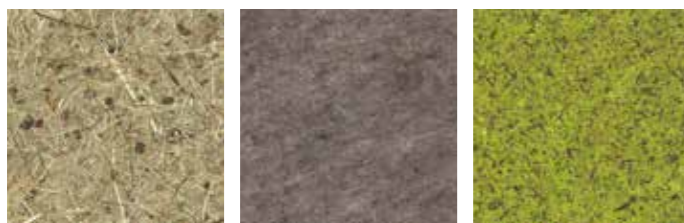

WILDSPITZE
[vɪltʃpɪtsə]

WOLLÄ
[ˈvɔlə]

MOUS
[ˈmøʊz]

KABELFARBEN CABLE COLOURS

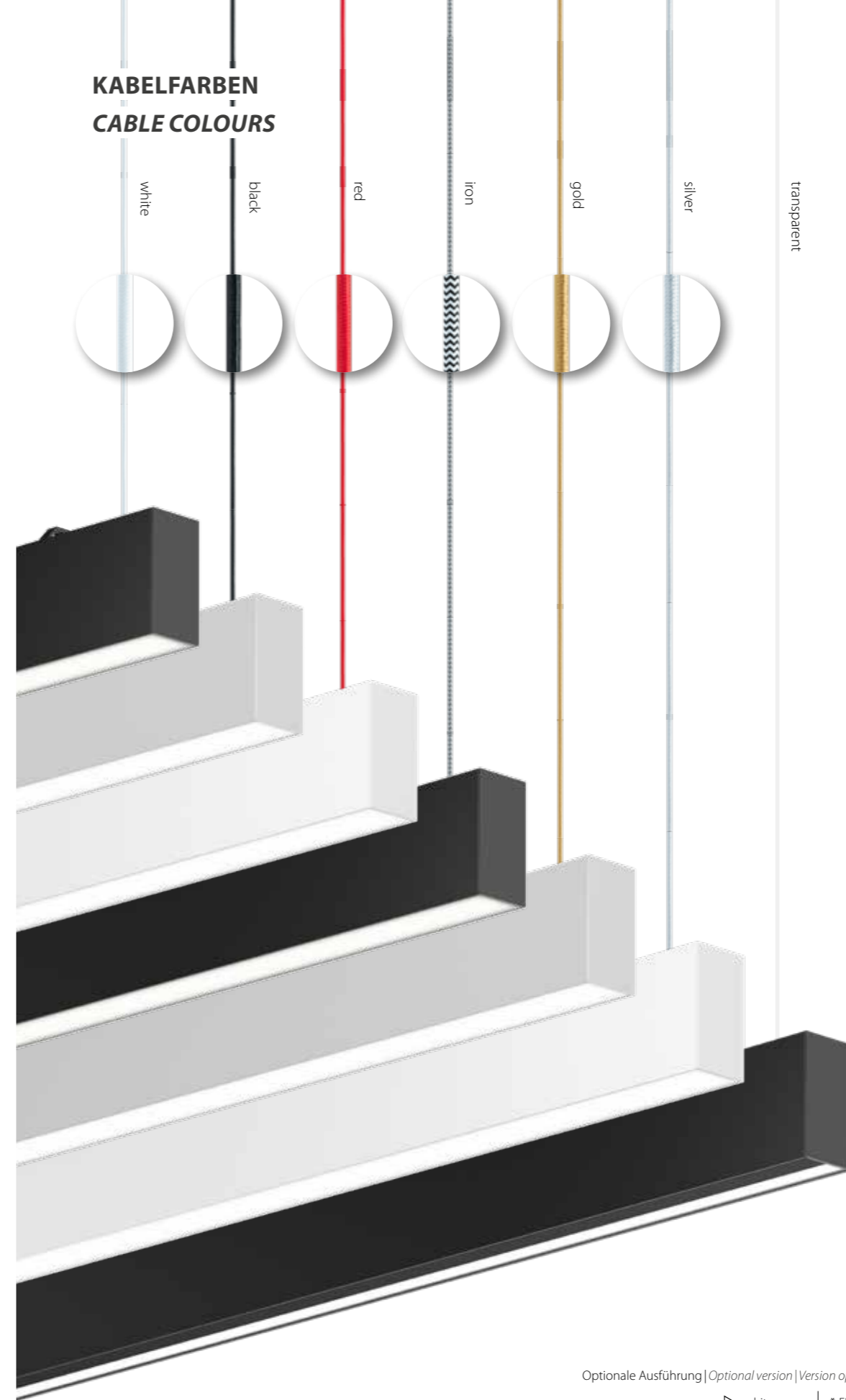

Optionale Ausführung | Optional version | Version optionnelle

Einspeisekabel
Suspension cable
Câble d'alimentation
Cavo di alimentazione

1750mm
5x0,75mm²

Transparentes Kabel inkl. (Standard Version)

▷ white	*-EIN-WHITE
◀ black	*-EIN-BLACK
◀ red	*-EIN-RED
▷ iron	*-EIN-IRON
▷ gold	*-EIN-GOLD
▷ silver	*-EIN-SILVER



für besondere Anfragen

WICHTIGE HINWEISE

Dieser Katalog richtet sich ausschliesslich an gewerbliche Kunden. Die in diesem Katalog angegebenen Werte sind Bemessungswerte und unterliegen produktionsbedingten Toleranzen*. Alle angeführten Angaben – insbesondere Grössen-, Material-, Farb- und technische Angaben – entsprechen dem Stand zum Zeitpunkt des Drucks und dienen ausschliesslich zur Information. Der Herausgeber haftet nicht für Satz- und Druckfehler sowie für Abweichungen der Produkte von Abbildungen und Angaben. PLANLICHT behält sich vor, jederzeit ohne Ankündigung Änderungen an Produkten vor zu nehmen. Es gelten die Allgemeinen Geschäftsbedingungen der planlicht GmbH & Co KG, die unter WWW.PLANLICHT.COM/AGB-LANDING/ eingesehen werden können.

Technische Kennzahlen, angeführte Werte und die Piktogramme betreffen zumindest einen aber nicht zwingend alle Artikel der jeweiligen Leuchtenfamilie, exakte Angaben je Artikel finden Sie im Online-Katalog bzw. in PLANLICHT-Verkaufsbelegen und Datenblättern.

WEEE-Reg.-Nr. DE 54728470

* Leistung, Lichtstrom und Farbtemperatur unterliegen durch den Einsatz von elektronischen Bauteilen produktionsbedingten Toleranzen. Toleranzen Leistung und Lichtstrom: +/- 10%. Toleranz Farbtemperatur: +/- 150 K. Lichtstrom dynamisch weiss bei 2700 K.

RELEVANTE INFORMATIONEN AUF EINEN BLICK

- Allgemeine Geschäfts- & Lieferbedingungen – Die Grundlage unserer Zusammenarbeit
- Garantie 66 – Das Qualitätsversprechen im Detail
- Technische Hinweise – Wichtige Informationen zur Planung
- Produktseiten – So lesen Sie unsere Übersichten
- Artikelnummer – Die Logik hinter dem Code
- Piktogramme – Die Symbole und ihre Bedeutung



IMPORTANT REMARKS

This catalogue is reserved for professionals only. The values published in this catalogue are rated values, which can slightly change for reasons related to the production process. The published data such as dimensions, materials, colours and technical data are valid at time of printing, and exclusively provided for informational purposes. The editor takes no responsibility for typographical and print errors, as well as for any differences in the products, pictures and data. PLANLICHT reserves the right to change the products at any time and without any notice. The Terms and Conditions of planlicht GmbH & Co KG (available on WWW.PLANLICHT.COM/AGB-LANDING/) shall apply.*

Key technical specifications, listed values as well as the pictogram bar relate to at least one but not necessarily all items of the respective luminaire family, exact details for each item can be found in the online web catalogue or in PLANLICHT sales documents and data sheets.

** The power output, luminous flux and colour temperature can be slightly different due to specific electronic components used in the manufacturing process. The power output and luminous flux can differ by +/- 10%. The colour temperature can differ by +/- 150 K. Luminous flux dynamic white at 2700 K.*

RELEVANT INFORMATION AT A GLANCE

- *Terms & Conditions – The Basis of Our Cooperation*
- *Guarantee 66 – Our Commitment to Quality*
- *Technical Notes – Essential Guidance for Planning*
- *Product Pages – How to Read Our Overviews*
- *Article Number – The Logic Behind the Code*
- *Pictograms – The Meaning Behind the Symbols*

IMPRINT

Publisher: planlicht GmbH & Co. KG, Vomp
Creative Concept: Katrin Atzinger
Graphic Design: Beatrice Praxmarer, Christoph Höflinger
© 2026



6134 Vomp, Austria, Au 25
Tel. +43-5242-71608, Fax +43-5242-71283
info@planlicht.com
WWW.PLANLICHT.COM



RINGLEUCHTEN

RING LUMINAIRES

WWW.PLANLICHT.COM